

AM-KPI

Access Control Keypad

Installation Instructions

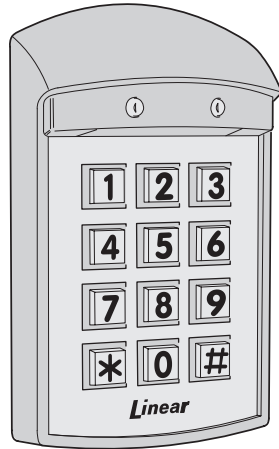

Linear

(760) 438-7000 • FAX (760) 438-7043
 USA & Canada (800) 421-1587 & (800) 392-0123
 Toll Free FAX (800) 466-1340
 www.linearcorp.com

1. INTRODUCTION

The Model AM-KPI keypad is designed for use with Linear's AM/II access control system. The keypad is housed in a rugged, plastic enclosure and is designed to be mounted indoors in a standard single-gang electrical box. Tamper resistant screws secure the keypad to its mounting plate. The die-cast keys have bright, easy-to-read yellow graphics.

The keypad is supplied with a satin-chrome plastic bezel installed. Three interchangeable colored plastic bezels (white, ivory, & bronze) are included with the unit to customize the keypad appearance for the installation.

All system indicators and lights are long-lasting, solid-state LEDs. Two indicators show the status of the entry system. The left indicator lights red to indicate power, then turns green when access is granted. The right indicator lights yellow when the keypad is in "lockout" condition (from too many incorrect code entries). A white LED downlight lights the keypad for nighttime use. An internal sounder beeps when each key is pressed.

The AM-KPI is normally powered from the AM/II controller. Alternately, the keypad can be powered locally with a 12 VDC power supply. Robust static and lightning protection circuits safeguard the keypad's electronics.

A rotary switch selects the keypad's device address. Each device connected to the AM/II must be set to a different device address.

2. KEYPAD FEATURES

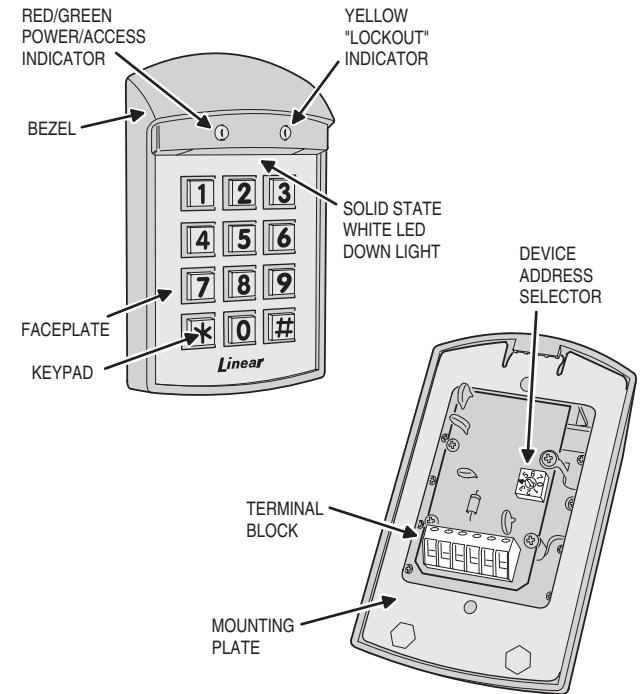

3. OPEN THE KEYPAD

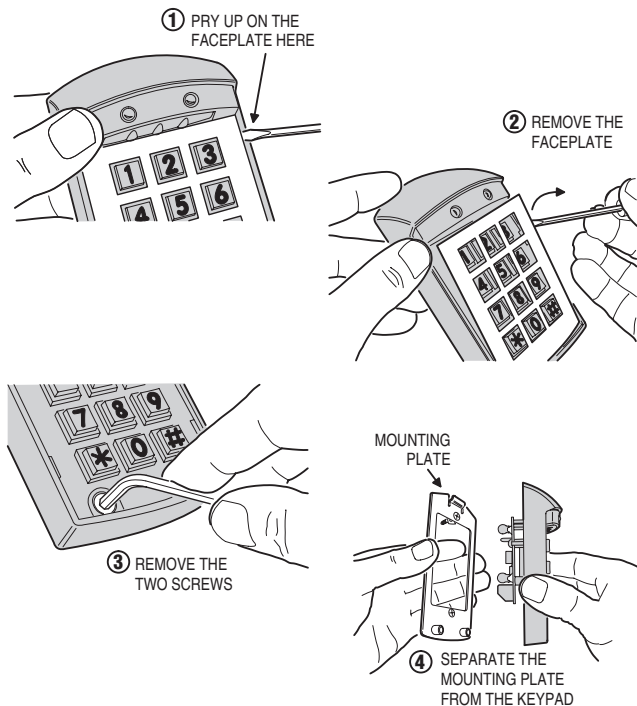

4. CUSTOMIZE THE BEZEL (OPTIONAL)

TO CHANGE THE APPEARANCE OF THE KEYPAD TO BLEND IN WITH THE INSTALLATION, CHOOSE THE APPROPRIATE KEYPAD BEZEL

KEYPAD BEZEL COLORS:

- SATIN-CHROME (FACTORY INSTALLED)
- WHITE
- IVORY
- BRONZE

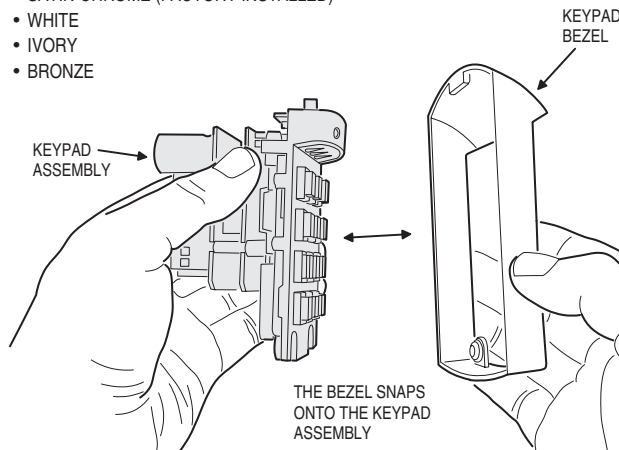

5. INSTALL WALL BOX & MOUNTING PLATE

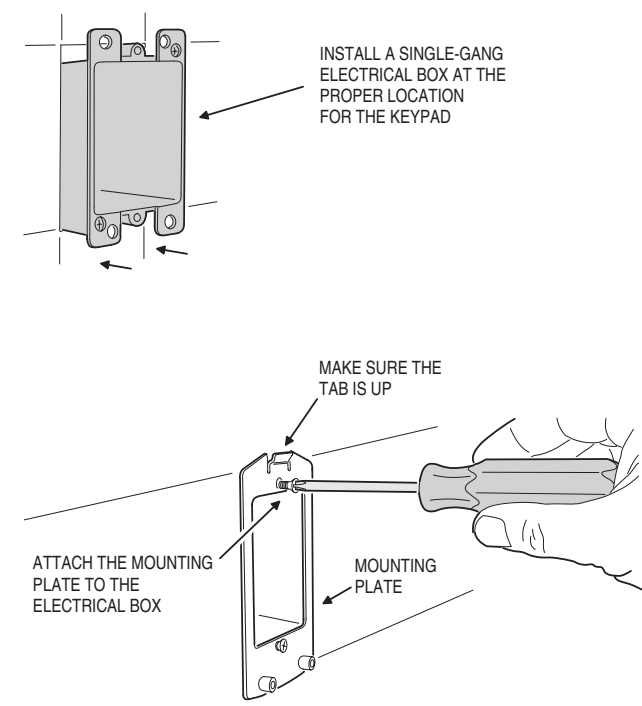

6. ROUTE THE CABLE

EACH AM-KPI KEYPAD EQUALS 9 LOAD UNITS

CABLE LENGTH FORMULA FOR EACH KEYPAD USED IN THE SYSTEM

CABLE RUN	CABLE TYPE	FORMULA
300 FEET MAXIMUM	BELDEN 9931 (24 AWG)	FEET x LOAD UNITS < 3,000 MAXIMUM
500 FEET MAXIMUM	WEICO 9405 (20 AWG)	FEET x LOAD UNITS < 10,000 MAXIMUM

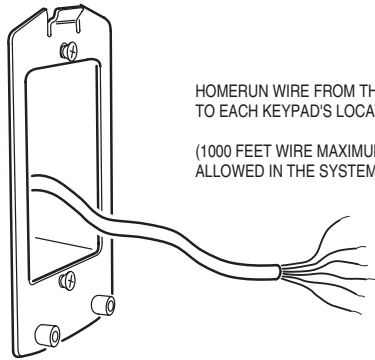

HOMERUN WIRE FROM THE AM/II TO EACH KEYPAD'S LOCATION

(1000 FEET WIRE MAXIMUM ALLOWED IN THE SYSTEM)

7. CONNECT THE CABLE & SET THE DEVICE ADDRESS

FOLLOW THIS WIRING DIAGRAM TO CONNECT THE KEYPAD TO THE AM/II CONTROL

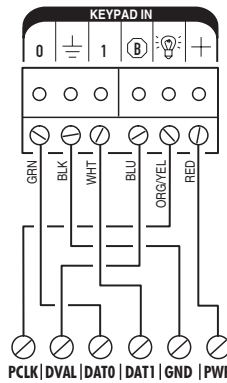

SET THE DEVICE ADDRESS SWITCH

EACH REMOTE DEVICE MUST BE SET TO A UNIQUE NUMBER FROM 1 TO 6

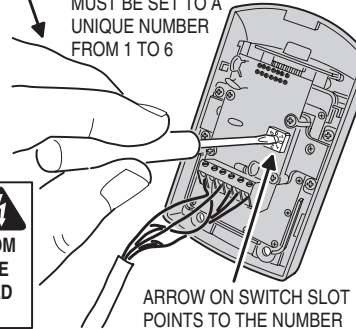

CAUTION
TO PROTECT THE KEYPAD FROM STATIC DISCHARGES, BE SURE EARTH GROUND IS CONNECTED TO THE AM/II CONTROL

FOR LOCAL POWER, DISCONNECT RED WIRE FROM "PWR" CONNECTION ON AM-KPI AND CONNECT EXTERNAL 12 VDC POWER SUPPLY (+ TO PWR & - TO GND)
NOTE: AM/II $\frac{+}{-}$ MUST STILL BE CONNECTED TO AM-KPI "GND"

8. MOUNT THE KEYPAD

1 HOOK THE KEYPAD ASSEMBLY ONTO THE MOUNTING PLATE

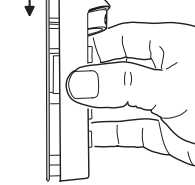

2 INSTALL THE TWO SCREWS

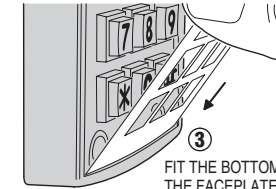
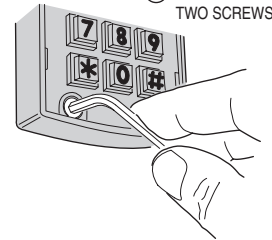

3 FIT THE BOTTOM TAB OF THE FACEPLATE INTO THE SLOT ON THE KEYPAD



4 SNAP THE TOP OF THE KEYPAD INTO PLACE

9. PROGRAM THE SYSTEM

PROGRAM THE AM/II TO CONFIGURE THE KEYPAD(S) AND SET THE ENTRY CODES

REFER TO THE AM/II PROGRAMMING INSTRUCTIONS FOR DETAILS

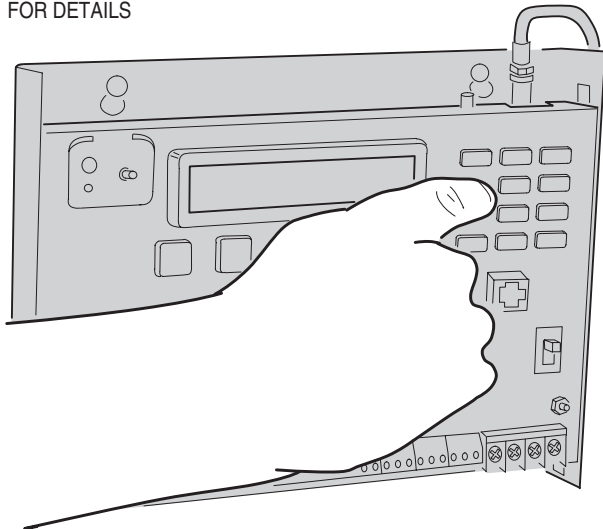

10. TEST THE KEYPAD

- 1 THE RED INDICATOR SHOULD BE LIT
- 2 ENTER A VALID CODE
- 3 THE RED INDICATOR SHOULD TURN GREEN AND THE PROGRAMMED RELAY IN THE AM/II SHOULD ACTIVATE

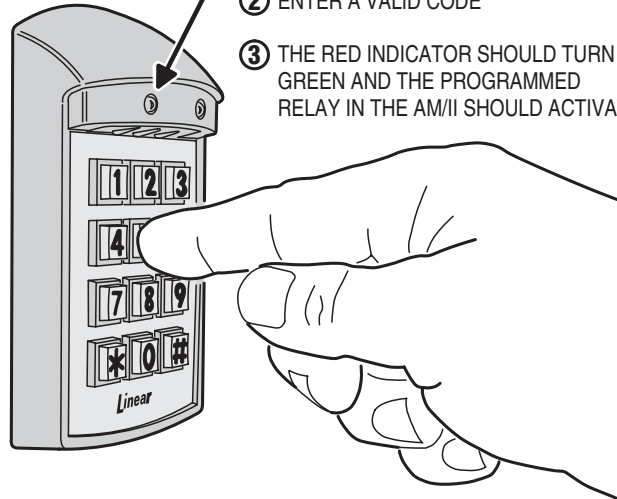

THE YELLOW INDICATOR LIGHTS WHEN THE KEYPAD IS LOCKED OUT OR BUSY

LINEAR LIMITED WARRANTY

This Linear product is warranted against defects in material and workmanship for twenty-four (24) months. The Warranty Expiration Date is labeled on the product. This warranty extends only to wholesale customers who buy direct from Linear or through Linear's normal distribution channels. Linear does not warrant this product to consumers. Consumers should inquire from their selling dealer as to the nature of the dealer's warranty, if any. **There are no obligations or liabilities on the part of Linear Corporation for consequential damages arising out of or in connection with use or performance of this product or other indirect damages with respect to loss of property, revenue, or profit, or cost of removal, installation, or reinstallation.** All implied warranties, including implied warranties for merchantability and implied warranties for fitness, are valid only until Warranty Expiration Date as labeled on the product. **This Linear Corporation Warranty is in lieu of all other warranties express or implied.**

All products returned for warranty service require a Return Product Authorization Number (RPA#). Contact Linear Technical Services at 1-800-421-1587 for an RPA# and other important details.

FCC NOTICE

Changes or modifications not expressly described in this manual or approved by the manufacturer could void the user's authority to operate the equipment.

This equipment has been tested and found to comply with the limits for a Class B digital device, pursuant to Part 15 of the FCC Rules. These limits are designed to provide reasonable protection against harmful interference in a residential installation. This equipment generates, uses and can radiate radio frequency energy and, if not installed and used in accordance with the instructions, may cause harmful interference to radio communications. However, there is no guarantee that interference will not occur in a particular installation. If this equipment does cause harmful interference to radio or television reception, which can be determined by turning the equipment off and on, the user is encouraged to try to correct the interference by one or more of the following measures:

- Reorient or relocate the receiving antenna.
- Increase the separation between the equipment and receiver.
- Connect the equipment into an outlet on a circuit different from that to which the receiver is connected.
- Consult the dealer or an experienced radio/TV technician for help.