

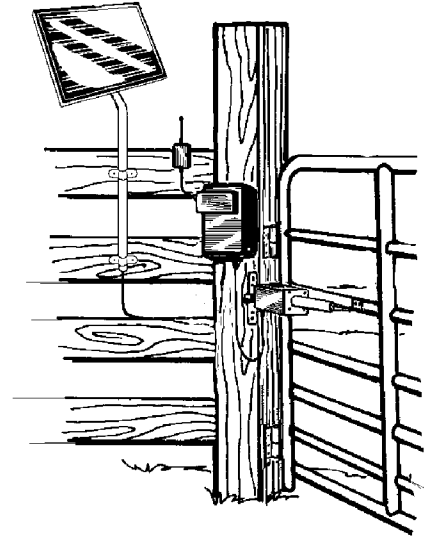

10 Watt

Solar Powered Battery Charger Installation Manual



For use with GTO/PRO gate opener models: SW1000, SW1500, SW2000, SW2500, SW2502, SW3000, SW4000, SL1000, and SL1000B. Also for use with Mighty Mule gate opener models: FM350, FM500, FM502, FM700, and FM702.

All dual gate installations require a minimum of 10 Watts of solar charging power.

Parts Included:

- A. Solar Panel
- B. Lag Screws (4)
- C. Pipe Clamp
- D. Curved Pipe
- E. 1/4" Nuts (4)
- F. 1/4" x 1/2" Bolt (4)

Tools Required :

- Slotted (flat blade) Screwdriver
- 7/16" open end wrench

GTO/PRO • 3121 Hartsfield Road • Tallahassee, Florida 32303 • (850) 575-0176 • Fax (850) 575-8912 • www.gtopro.com
 Technical Service (850)575-4144

Solar Panel Installation

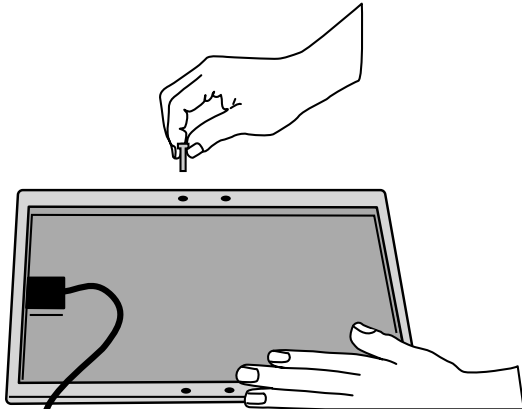

Step 1: Slide the 1/4" bolts (F) into each channel, position the pipe (D) between the bolts and place two clamps (C) over the curved pipe onto the bolts. Secure with the 1/4" nuts (E).

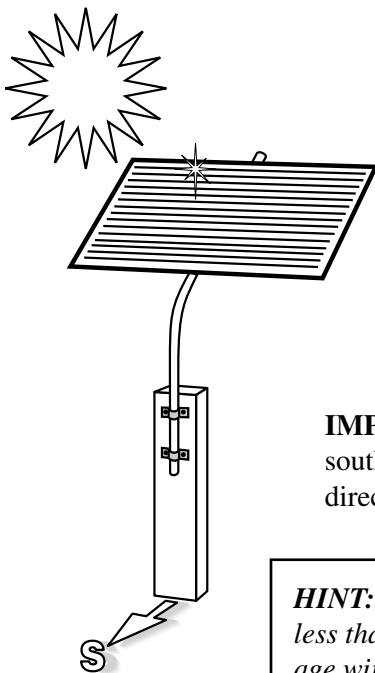
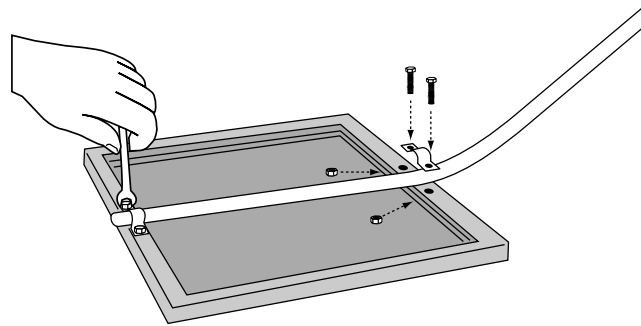

Step 2: Determine the site for installation of the solar panel. It is important to install the solar panel **facing the path of the sun** where full sun will strike its face throughout the day. The curved pipe (D) maintains the proper angle to the sun. Secure the solar panel assembly to a wooden post or fence using two pipe clamps (C) and #2 lag screws (B) as shown in the illustration. If your fence post is metal, you will need alternative hardware not provided, (i.e. U-clamps or metal screws).

IMPORTANT: the solar panel must be positioned facing the path of the sun, due south and in an open area away from shade. It should receive at least 8 hours of direct sunlight for a full charge.

HINT: If the solar panel must be placed more than 10 ft. from the control box (but less than 250 feet away), use multi-stranded, 16 gauge (AWG), direct burial, low-voltage wire (see Accessory Catalog). **Never use telephone wire or solid core wire.**

IMPORTANT: To provide secure and moisture resistant splices for solar panels, key pads, push buttons and other accessories use a direct burial splice kit for underground splices and an above ground splice kit for above ground splices. These splice kits can be found at hardware and electrical supply stores.

HINTS for Obtaining Maximum Output from Your Solar Panel

1. Place the panel facing due south in the path of the sun, where full sun will strike its face throughout the day (minimum 8 hours).
2. Mount the panel using the curved pipe provided to maintain the proper angle to the sun.
3. For optimal efficiency, wipe the face of the panel frequently with a soft, damp cloth.

The output of the Solar Panel is variable during the day depending on the intensity of the sun and the angle of the rays striking the panel. The output may vary from a few millivolts to as much as 22 volts. To check the output, simply disconnect the solar panel leads from the control board and connect them directly to a dc voltmeter. In bright sunlight the panel output should read at least 18 volts dc.

Step 3: All GTO/PRO DC powered gate operators have a **POWER IN** terminal on their control boards marked **SOLAR** for connecting the solar panel wires. Below are various types of terminals on GTO/PRO and Mighty Mule control boards, if your control board doesn't have this terminal, please call the GTO's Technical Service Department at (800)543-1236 or (850)575-4144 for assistance.

Feed the free end of the solar panel wires into the control box and attach them to the **SOLAR** terminals on the **POWER IN** terminal block on the control board. The **RED** solar panel wire goes to the (+) **POSITIVE** Solar terminal and the **BLACK** solar panel wire goes to the (-) **NEGATIVE** Solar terminal. See diagram below.

IMPORTANT: Improper installation of these wires will damage to the opener's control board.

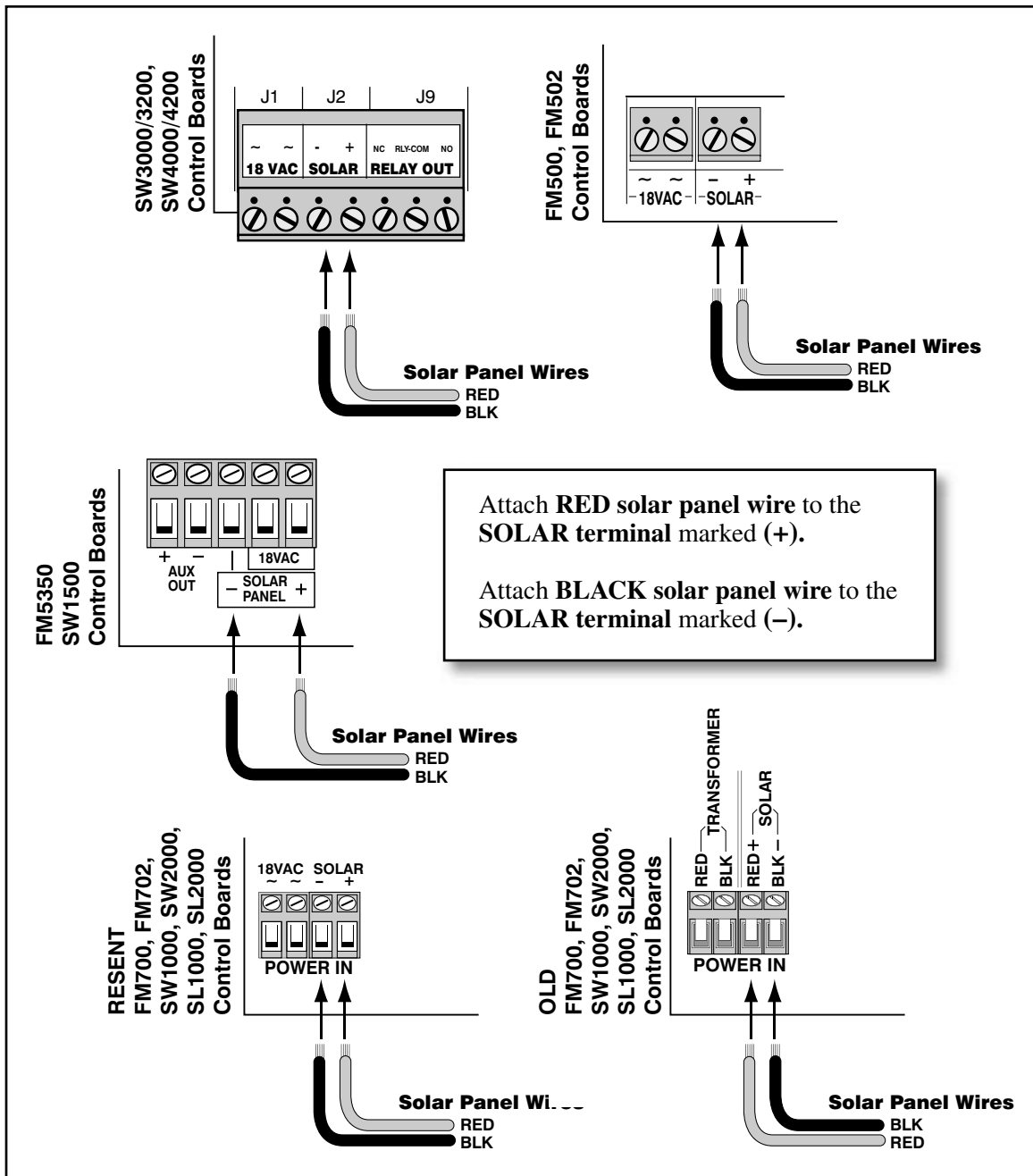

Solar Zones and Gate Activity

Use the table and map to determine the number of operational cycles* per day to expect in your area, using 5 to 30 Watts of charging power. Figures are shown for winter (minimum sunlight) and do not account for the use of any accessory items.

*An operational cycle is one full opening and closing of the gate.

Estimated Gate Openings Per Day

Winter Ratings	Zone 1	Zone 2	Zone 3
Single gate installation with 10 Watts of charging power	8	16	26
Single gate installation with 20 Watts of charging power	14	28	38
Single gate installation with 30 Watts of charging power	20	44	54
Dual gate installation with 10 Watts of charging power	4	8	13
Dual gate installation with 20 Watts of charging power	10	18	27
Dual gate installation with 30 Watts of charging power	16	28	41

All dual gate installations require a minimum of 10 Watts of solar charging power.

Accessories will draw additional power from the battery; the more accessories you connect, the more power your system will require.

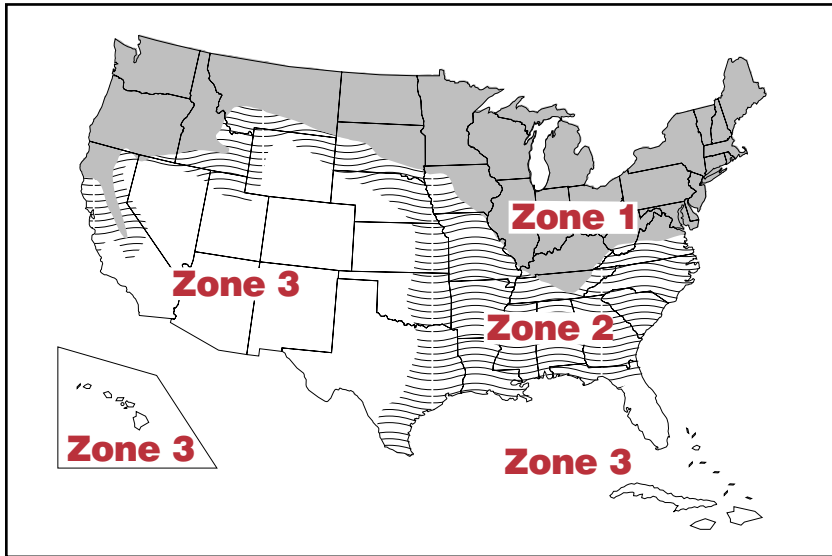

Multiple Panel Installations

NOTE: All connections should be weather proofed using weather proof splice kits available at hardware and electrical supply stores.

Solar Panels connect in PARALLEL

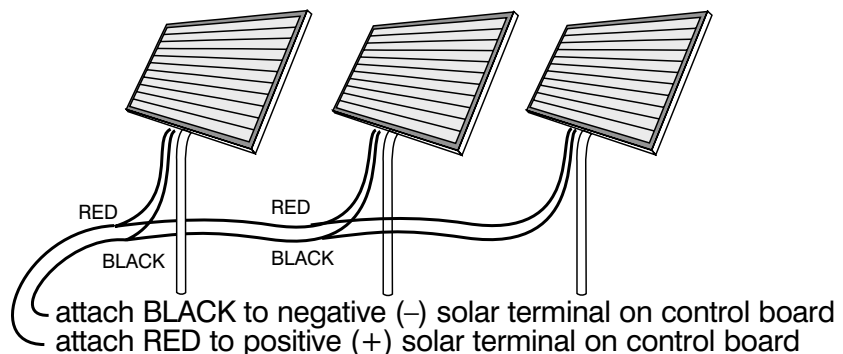

Other GTO/PRO Access Controls and Accessories

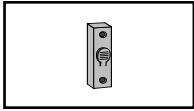

Push Button (doorbell) Control (RB101)

Unlit doorbell button for remote entry or exit control. Wires directly to the control board and uses 16 gauge (AWG), multi-stranded, dual conductor low voltage wire (sold separately).

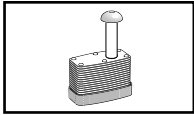

Pin Lock (FM134)

The Pin Lock substitutes for the clevis pin at the front end of the GTO/PRO® gate openers. Helps prevent theft of the opener from the gate, while allowing quick release of the opener.



Key Chain Mini Transmitter (RB744)

The Key Chain Mini Transmitter is a miniature version of the GTO/PRO® entry transmitter and has the same adjustable code settings. 12 Volt battery included.

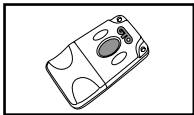

Entry Transmitter (FM135)

The GTO/PRO® entry transmitter, with adjustable code settings, is standard equipment with all GTO/PRO® systems. 12 Volt battery included.

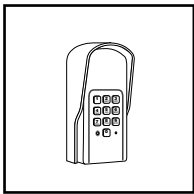

Digital Keypad (FM137)

The specially designed digital keypad can be easily installed as a wireless or wired keypad. It can be programmed to use up to 25 different personal identification number (PIN) codes. Each code is face programmable with additional security features built in. Wired installations require 16 gauge (AWG), low voltage, multi-stranded, dual conductor, direct burial wire (sold separately). Requires 3 AA batteries (not included).

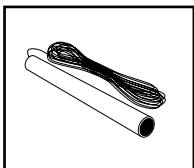

GTO/PRO 50' Exit Wand (FM139), 100' Exit Wand (FM140), 150' Exit Wand (FM141)

The GTO/PRO® Exit Wand is designed for residential and agricultural applications and is compatible with all GTO/PRO® automatic gate operator models. The wand is an electromagnetic sensor, which offers 'hands free' operation of the GTO/PRO® Gate Operators with a 12 ft. radius of detection of vehicles in motion.

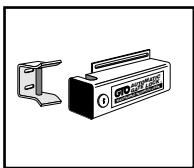

Automatic Gate Lock Pull-to-Open (FM144)

A MUST for added security. Solenoid driven with a steel housing. Unlocks and locks automatically as gates open and close. Used with the Mighty Mule® system for maximum stability and security. Comes with a keyed manual release. Recommended for gates over 8 ft. long. Ideal for animal enclosures or high wind areas.

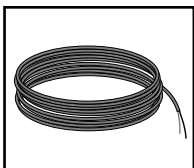

Low Voltage Wire (RB509)

The 16 gauge (AWG), multi-stranded, dual conductor **Low Voltage Wire** is for connecting the AC powered transformer, or the **Solar Panel** to the control board. Also used for connecting accessories, such as locks, keypads, push buttons and other wired control devices. This specially designed wire is UV treated, PVC coated and ready for direct burial. Available in 1000' rolls or special lengths.

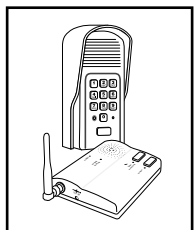

Wireless Entry Intercom / Keypad (FM136)

Allows owner to screen guest at the gate before allowing access to the property. Keypad also allows owner to give up to 25 programmable entry codes to family, friends or approved delivery personnel. Codes can be permanent or temporary. Can be wireless or hard wired up to 1000 feet.

Other GTO/PRO Access Controls and Accessories

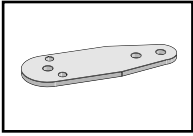

11" Push to Open Bracket (347IH)

Required when GTO/PRO® gate opener(s) must push the gate open, such as on a sloping driveway or where space prevents gate(s) from opening inward (pulled open). Order two PTO brackets for conversion of a dual swing gate installation.

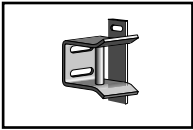

Column Mount Lock Receiver (433IH)

For mounting the Automatic Gate Lock on brick columns, walls, or for other applications with limited space between gate and post.

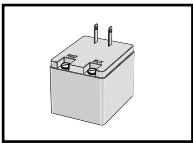

Replacement Transformer (RB570)

Standard 18 volt AC transformer for maintaining the battery included with the GTO/PRO® gate opener. This is the only transformer approved for use with all UL325 GTO/PRO® gate opener systems.

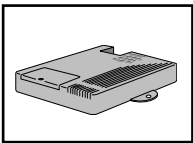

Garage Door Receiver (RB709)

The Garage Door Receiver allows you to use the same GTO/PRO® entry transmitter (see Dual and Triple Transmitters) to operate your gate opener and your garage door opener. Compatible with most garage door openers.

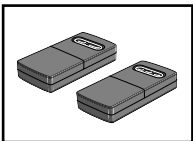

Dual & Triple Button Transmitters (RB742 & RB743)

The Dual (RB742) & Triple (RB743) Button Transmitters are for remote control of multiple separate gate openers, and/or gate opener(s) and garage door opener(s) (see Garage Door Receiver). 9 Volt battery included.

**If you have a question about any special order item,
just call 1-800-543-GATE!**



3121 Hartsfield Road • Tallahassee, Florida, USA 32303
Telephone GTO/PRO Sales: 1-800-543-GATE (4283) or (850) 575-0176 • Fax (850) 575-8912
or GTO Technical Service: 1-800-543-1236 or (850) 575-4144 • Fax (850)575-8950
www.gtopro.com

The contents of all material available on this installation manual are copyrighted by GTO, Inc. ("GTO"), unless otherwise indicated. All rights are reserved by GTO, and content may not be reproduced, downloaded, disseminated, published, or transferred in any form or by any means, except with the prior, written permission of GTO. Any reprinting of GTO publications is by permission only. Copyright infringement is a violation of federal law.

Mighty Mule®, E-Z Gate®, GTO/PRO®, are registered trademarks of GTO, Inc. America's DIY Automatic Gate Openers is a trademark of GTO, Inc. and are the exclusive property of GTO, Inc. ("GTO"). All rights are reserved by GTO, and these marks may not be used, in any for without the prior, written permission of GTO.