

# EverNew®

## Vinyl Railing & Deck Systems



# STEP-BY-STEP INSTALLATION INSTRUCTIONS FOR DECK AND OXFORD RAILING

Both EverNew decking and the Oxford railing system achieved certification from the NES (National Evaluation Services) prior to the formation of the ICC (International Code Council). This means these products are in compliance with all of the model building codes that fall under the ICC and therefore, IBC (International Building Code) approved. Our NES approval designation is NER-605.

### TABLE OF CONTENTS

- Before You Begin ..... 1
- Locate and Install Post Supports ..... 4
- Install Vinyl Decking ..... 7
- Install Railing Sections ..... 10
- Install Rail Connectors and Post Caps ..... 12
- Bracket and Railing Installation ..... 13
- Install the Stair Railing ..... 16
- Gate Installation ..... 18
- Care and Maintenance ..... 19

## BEFORE YOU BEGIN

### TOOLS REQUIRED FOR INSTALLATION

- 2" hole saw
- Carbide tipped multi-purpose blade
- Carpenter's pencil
- Chop (mitre) saw
- Circular saw
- Drill bits
  - 1/2" (wood post support)
  - 1/2" masonry (concrete post support)
  - 3/16" (rail plate)
  - 1/8" (post cap)
  - 1/4" (end cover fastener)
  - 3/4" spade (fascia plug)
- Drop cloth
- Level
- Power Drill
- Safety glasses
- Screwdrivers
  - Phillips and slotted
- Square
- Tape rule
- Wood clamps
- Wrenches (sockets)
  - 3/4" (post support)
  - 7/16" (E-Z Set bracket)
  - 3/8" (rail plate)

### OPTIONAL TOOLS

- Bevel guide
- Chalk line
- File
- Jigsaw/Hacksaw
- Post Router Template Kit\*
- Rotary hammer drill
- Utility knife

\*Available from CertainTeed

Make sure you have all the pieces you need to complete the job. Separate your flat and stair pieces to avoid using the wrong ones.

### POST SUPPORTS

Post supports for stair rail are longer than those for flat rail. See table below.

#### POST SUPPORT LENGTHS

Deck & Railing System	Flat	Stair
3' on Wood	43"	53"
3' on Concrete	37"	48"
3-1/2' on Wood	49"	53"
3-1/2' on Concrete	43"	48"

Stair post supports are for **F**, **H**, and **I** posts (see next page).



Your post support kit should include:

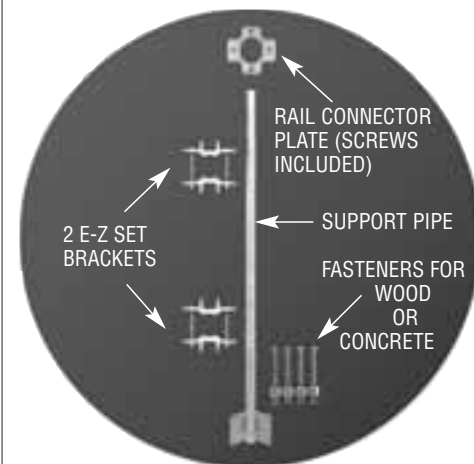

### IMPORTANT:

Always wear safety glasses when cutting or drilling components.

If your installation requires solutions different from those in this book, please contact installation support at 1-800-380-5323.



FLAT POSTS



END POST



LINE POST



CORNER POST



45° LINE POST

STAIR POSTS



FLAT TO STAIR  
CORNER LEFT



FLAT TO STAIR  
CORNER RIGHT



LINE POST STAIR



FLAT TO STAIR  
LINE POST



END POST STAIR

POST OPTIONS

There are two post styles, Square and Newel, which can be used with post support kits or fitted over installed 4x4 wood posts.



SQUARE



NEWEL

For an all-vinyl system, white Porch Post covers can be fitted over conventional load-bearing porch posts.

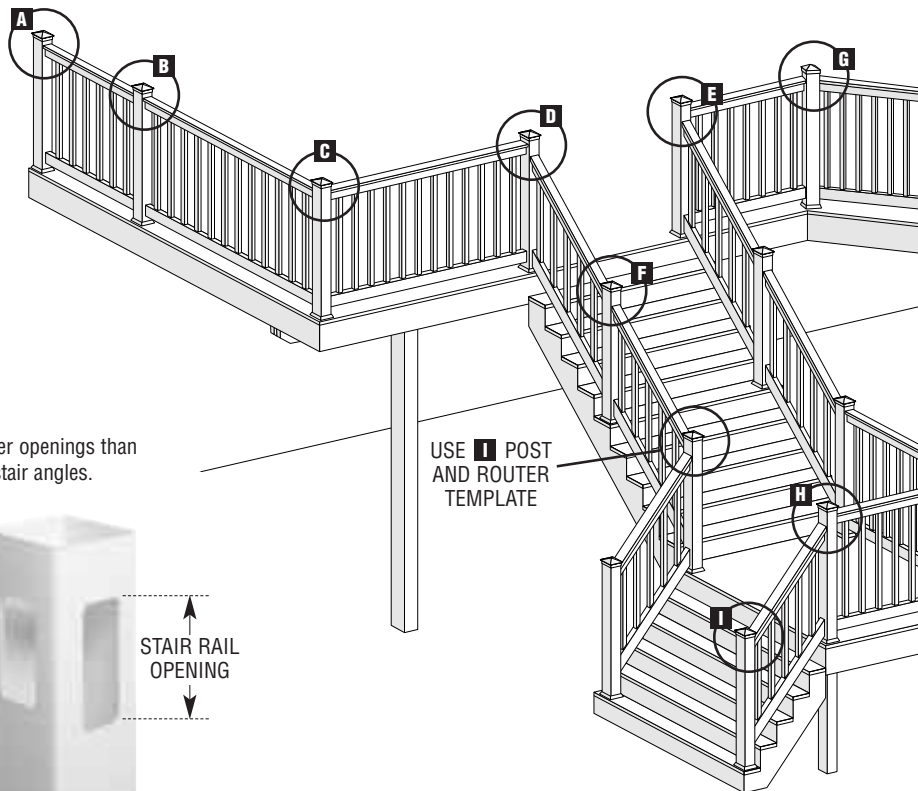

Stair posts have wider openings than flat posts to accept stair angles.

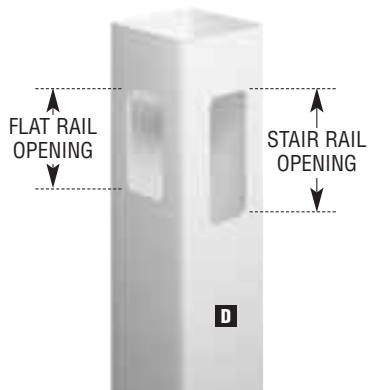

USE **I** POST AND ROUTER TEMPLATE

## RAILS

Stair baluster spacing and holes are wider to account for racking. Racking is the tendency of stair balusters to come closer together as the angle of the stairs increases.

### BALUSTER SPACING

FLAT

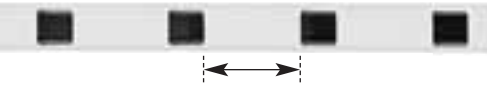

STAIR



### RAIL DIMENSIONS

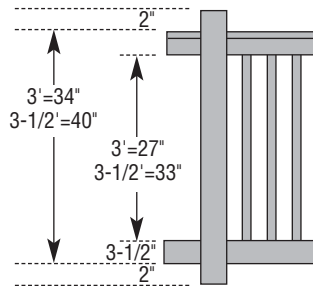

### TOP RAIL STYLE



## BALUSTERS

Flat rail balusters are 1-1/2" longer than stair rail balusters. See table below.

You can cut flat rail balusters down to make stair rail balusters. Do not cut on an angle. When cutting Colonial balusters, cut 3/4" off each end. Use care when installing glass balusters.

Note: Glass baluster is the same for flat and stair.



### BALUSTER LENGTH

Railing System	Flat	Stair
3' Square/Colonial	33-1/4"	31-3/4"
3-1/2' Square/Colonial	39-1/4"	37-3/4"
3-1/2' Glass	38-1/4"	38-1/4"

## POST CAPS

### SQUARE POST CAPS



FLAT CAP - INTERNAL



NEW ENGLAND CAP



FLAT CAP - EXTERNAL



BALL CAP



GOTHIC CAP

### NEWEL POST CAPS

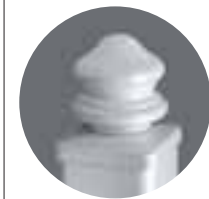

KING NEWEL CAP



QUEEN NEWEL CAP

## RAIL MOUNT BRACKETS

Aluminum brackets screw to post or wall providing a solid, durable connection.



RAIL MOUNT BRACKET SYSTEM



ALTERNATE RAIL MOUNT SYSTEM

## OPTIONAL TRIM

### POST TRIM



TWO PIECE

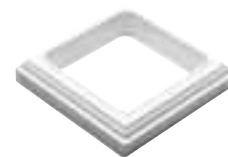

DECORATIVE POST TRIM



## STEP 1: LOCATE THE POST SUPPORTS

Locate and mark the post centers. For flat sections, make sure the post centers are no more than 120" apart.

For stair sections, determine if the rail will reach the bottom of the steps (or the landing). Place a rail on the stringer (make sure the rail extends beyond the top post support). If the rail does not reach the end of the stairs, you will need to use an intermediate post (see chart below). Center the top stair post within 3-1/4" of the edge of the deck.

Railings can also be mounted to walls or structural columns with wall mount brackets.

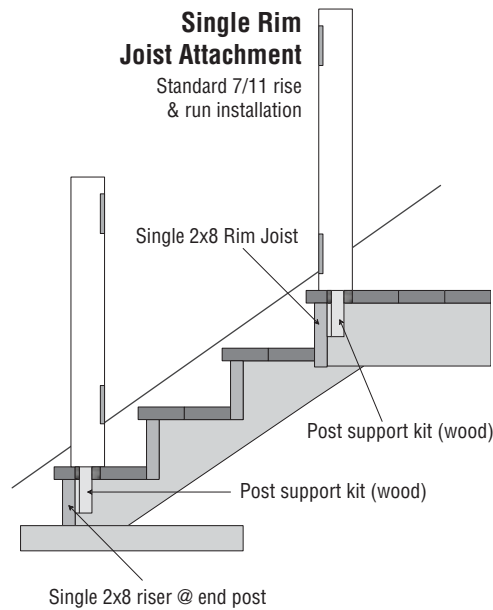

## STEP 2: CHECK THE SUBSTRUCTURE

Once you have laid out the location of the posts, check the substructure to make sure there are two surfaces available to mount the post support. For example, if you run along the length of a 12' deck and put a post in the middle, attach a bridge board in the middle of that run from the rim joist to the inner. Attach one side of the post support "L"-shaped bracket to the outside face; attach the other to the bridge.

## STEP 3: DETERMINE POST HEIGHT

Posts are supplied in two standard heights, 38" (3' railing) and 44" (3-1/2' railing). Stair post supports are purposely supplied longer than needed to accommodate various post positions.

## TIP #1:

*When cutting metal post supports for stair, cut away from vinyl decking to avoid metal particles from embedding into deck surface.*

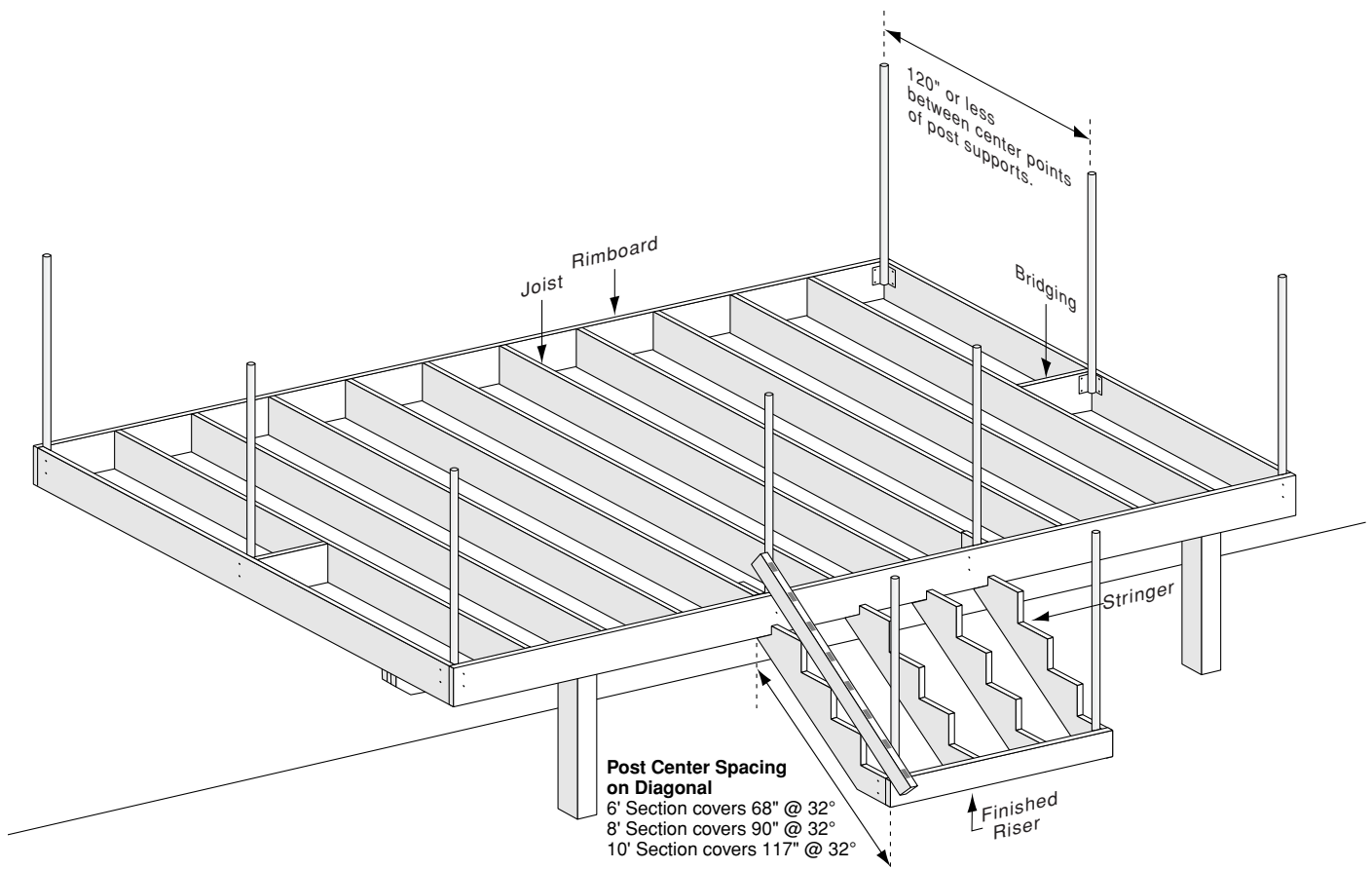

## STEP 4 INSTALL POST SUPPORTS

### WOOD STRUCTURE

For all post supports, the top of the L-shaped plate must be LEVEL WITH THE TOP OF THE JOISTS. If you mount them at the bottom, the pipe may not extend far enough to attach the rail lock plate later in the installation.



Clamp the post support in place. Make sure it's level. Check its height relative to the vinyl post. It must rise approximately 3/4" above the routed opening of the top rail. Remember to allow for the thickness of the deck plank.



Use the post support as a guide and drill four 1/2" holes through the joists.



Insert all four fasteners. Tighten.



Recheck level; if the joists are not plumb, use a washer as a shim to level the post support.

### CONCRETE SURFACE

You can also attach railing to a concrete surface using the concrete post mount system. Concrete post supports have a flat bottom plate. Position them a minimum of 3-1/2" on center from the edge of the concrete pad.



To install the posts on concrete, use the concrete mounting plate as a guide to mark holes.



Drill the four 1/2" holes 3-1/4" deep.



Attach a nut to the top of the anchor to protect the threads and hammer it into the concrete. Leave approximately 3/4" of the thread above the ground.



After all anchors are in place, replace the post support and tighten the nuts. Recheck that the post is level. If not, shim the base.

### IN GROUND

For a 3' rail, use a 72" ground mount stair post. For a 3-1/2' rail, use a 76" post.



Dig a 10" diameter hole approximately 30" deep or to the frost line in your area.



Position the post support in the hole. Install the stair rail section.



Check the height and fill the hole with concrete until it is approximately 2" from the top of the hole. Check that the post is square and level.

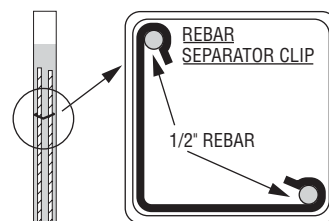

Put two pieces of rebar in opposing corners inside the post. The rebar should extend from the bottom of the hole to 12" from the top of the post. Fill the post with concrete to just above the rebar. Tamp the post with a rubber mallet to eliminate air pockets. Allow 72 hours for the concrete to set.

# 2. INSTALL VINYL DECKING

## APPLICATION TECHNIQUES

The substructure for vinyl deck is the same as for a wood deck. It should be substantial and built with high quality lumber. In general, the substructure for a vinyl deck is built on 16" centers. All decks designed with diagonal layouts should be installed on 12" centers.

CertainTeed vinyl deck meets the appropriate building standards set by the ICC. Before you install it, verify that the substructure meets all relevant codes.

### WARNING:

Due to expansion and contraction, installation of vinyl deck planks directly onto concrete is not recommended.

## STEP 1 SPACING

There are three options for laying out the deck:

### FULL RUN

Vinyl planks should be installed on 16" centers. Build the substructure 3" shorter than the plank length for proper overhang, 1-1/2".

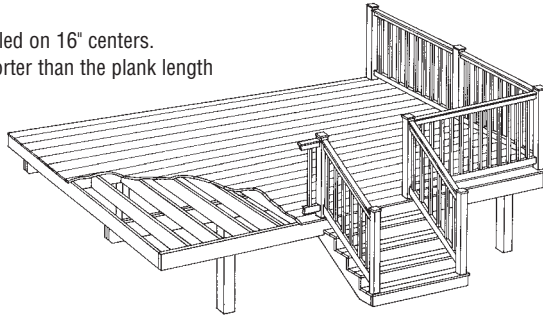

### UNIFORMLY STAGGERED

Staggered patterns hide seams better than aligned seams. This illustration shows a 4'-12" pattern, followed by a 12'-4" pattern. Repeating the sequence of patterns will create uniformly staggered seams. Seams must be double jointed.

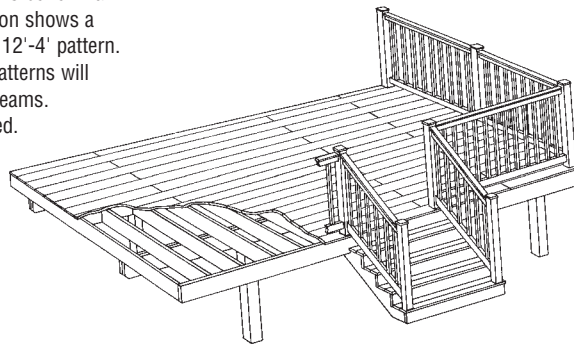

### DIAGONAL

Diagonal layouts should be built on substructures with 12" joisting. Seams must be double jointed.

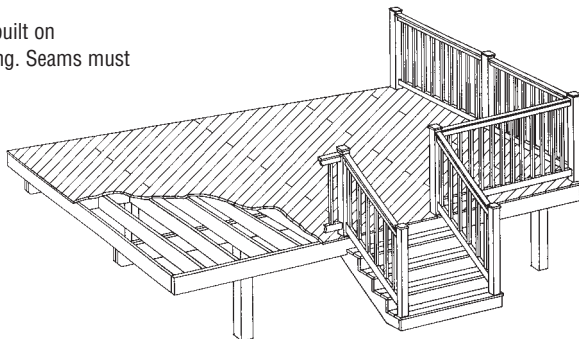

## VINYL DECK PLANK DEPTH/PROJECTION

**REMEMBER:** When specing the number of planks needed for your deck to take into account plank spacing.

Use this chart to help you calculate the number of planks you will need and account for proper overhang.

1/8" Spacing	3/16" Spacing	1/4" Spacing	# Planks
0' 5 1/2"	0' 5 1/2"	0' 5 1/2"	1
0' 11"	0' 11"	0' 11 1/2"	2
1' 4 1/2"	1' 5"	1' 5"	3
1' 10 1/2"	1' 10 1/2"	1' 11"	4
2' 4"	2' 4"	2' 4 1/2"	5
2' 9 1/2"	2' 10"	2' 10"	6
3' 3 1/2"	3' 3 1/2"	3' 4"	7
3' 9"	3' 9 1/2"	3' 10"	8
4' 2 1/2"	4' 3"	4' 3 1/2"	9
4' 8"	4' 8 1/2"	4' 9"	10
5' 1 1/2"	5' 2 1/2"	5' 3"	11
5' 7 1/2"	5' 8"	5' 9"	12
6' 1"	6' 1 1/2"	6' 2 1/2"	13
6' 6 1/2"	6' 7 1/2"	6' 8 1/2"	14
7' 0"	7' 1"	7' 2"	15
7' 6"	7' 7"	7' 7 1/2"	16
7' 11 1/2"	8' 1 1/2"	8' 1 1/2"	17
8' 5"	8' 6"	8' 7"	18
8' 11"	9' 0"	9' 1"	19
9' 4 1/2"	9' 5 1/2"	9' 7"	20
9' 10"	9' 11 1/2"	10' 1 1/2"	21
10' 3 1/2"	10' 5"	10' 6 1/2"	22
10' 9 1/2"	10' 10 1/2"	11' 0"	23
11' 3"	11' 4 1/2"	11' 5 1/2"	24
11' 8 1/2"	11' 10"	11' 11 1/2"	25
12' 2"	12' 3 1/2"	12' 5 1/2"	26
12' 8"	12' 9 1/2"	12' 11"	27
13' 1 1/2"	13' 3"	13' 5"	28
13' 7"	13' 8 1/2"	13' 10 1/2"	29
14' 1 1/2"	14' 2 1/2"	14' 4"	30
14' 6 5/8"	14' 8"	14' 10"	31
15' 0"	15' 2"	15' 4"	32
15' 5 1/2"	15' 7 1/2"	15' 9 1/2"	33
15' 11"	16' 1"	16' 3"	34
16' 4 1/2"	16' 7"	16' 9"	35
16' 10 1/2"	17' 1/2"	17' 3"	36
17' 4"	17' 6"	17' 8 1/2"	37
17' 9 1/2"	18' 0"	18' 2 1/2"	38
18' 3"	18' 5 1/2"	18' 8"	39
18' 9"	18' 11 1/2"	19' 1 1/2"	40
19' 2 1/2"	19' 5"	19' 7 1/2"	41
19' 8"	19' 10 1/2"	20' 1 1/2"	42
20' 1 1/2"	20' 4 1/2"	20' 7"	43
20' 7 1/2"	20' 10"	21' 1"	44
21' 1"	21' 4"	21' 6 1/2"	45
21' 6 1/2"	21' 9 1/2"	22' 0"	46
22' 0"	22' 3"	22' 6"	47
22' 6"	22' 9"	23' 0"	48
22' 11 1/2"	23' 2 1/2"	23' 5 1/2"	49
23' 5"	23' 8"	23' 11 1/2"	50
23' 10 1/2"	24' 2"	24' 5"	51
24' 4 1/2"	24' 7 1/2"	24' 10 1/2"	52

### EXAMPLE:

If your overall deck measures 7' 0" and you plan to use 1/8" spacing, you will need exactly 15 planks in either direction in a full run deck layout.

## STEP 2 FASTENING TO THE SUBSTRUCTURE

For all but diagonal layouts and stairs, install vinyl deck planks on substructures built on 16" centers. The unsupported span of vinyl deck planks must not be more than 4" overhang from the edge.



Align the first plank on the substructure. Overhang the substructure 1-1/2" on each end. Mark the board for the post supports. With a 2" hole saw, drill the deck board to accept the 1-5/8" post supports. Lay the board over the post supports. Square the board on the deck, and attach the first plank to the substructure.



Boards must be fastened every 16". The deck boards are fastened directly to the substructure with #8 x 2" deck screws. Seat the screws in the channels of the plank and do not over-tighten the screws.



After the first run has been installed, line up the next board. Gap it 1/8". Recheck the alignment and screw the board to the deck.



### TIP #2:

*If you are butting two boards, the seam must be double joisted.*

## STEP 3 INSTALL FILL PIECES



After all the boards have been installed, insert the fill pieces, several at a time, into the channels.



Begin by pressing in the leading edge; then slide a block of wood along the length of the fill strips until they are pressed in place.

Fill pieces should fill the entire channel but not overhang the vinyl deck.

The ends of the fill pieces do not have to coincide with the plank ends. They can be spliced into the deck channel.

## STEP 4 TRIM THE DECK



Measure the edge of the deck. Leave 1-1/2" of overhang for the end cover. Snap a chalk line on the deck to mark your cut. Cut along the line with a circular saw. Make sure the edge of the deck is straight.

## STEP 5 INSTALL "C" CHANNEL

To finish the deck, install vinyl "C" Channel over the open plank ends.



Using a chop saw equipped with a fine tooth carbide blade, cut the length of "C" channel you need.



Fit the channel onto the edge of the planks, ensuring that it is square.



Drill 1/4" holes through the top of the "C" channel. Drill at 1' increments (in the center of every other plank). Press the end-cover fasteners through the holes into the deck.



For concealed edges (along the house), or to cover ends of fascia, cut "C" channel into "L" channel with a utility knife and snap off. Install as described above.

## STEP 6 INSTALL FASCIA



Cut the fascia boards to length.



Attach the fascia to the sub-structure with #8 x 1-1/2" screws.



If using "L" channel, after the entire fascia has been installed, press end cover fasteners into the holes.



Drill 3/4" holes through one side of the fascia until the drill tip touches the other side. Do not drill a 3/4" hole all the way through the board. For 6" fascia, drill one hole through the top and one at the bottom every 2' along the length of the board. For 3 and 1-1/2" fascia, drill one hole every 2'.



Butt the fascia board as needed to cover the substructure. Miter cut the corners or finish the ends with "L" channel as described earlier.

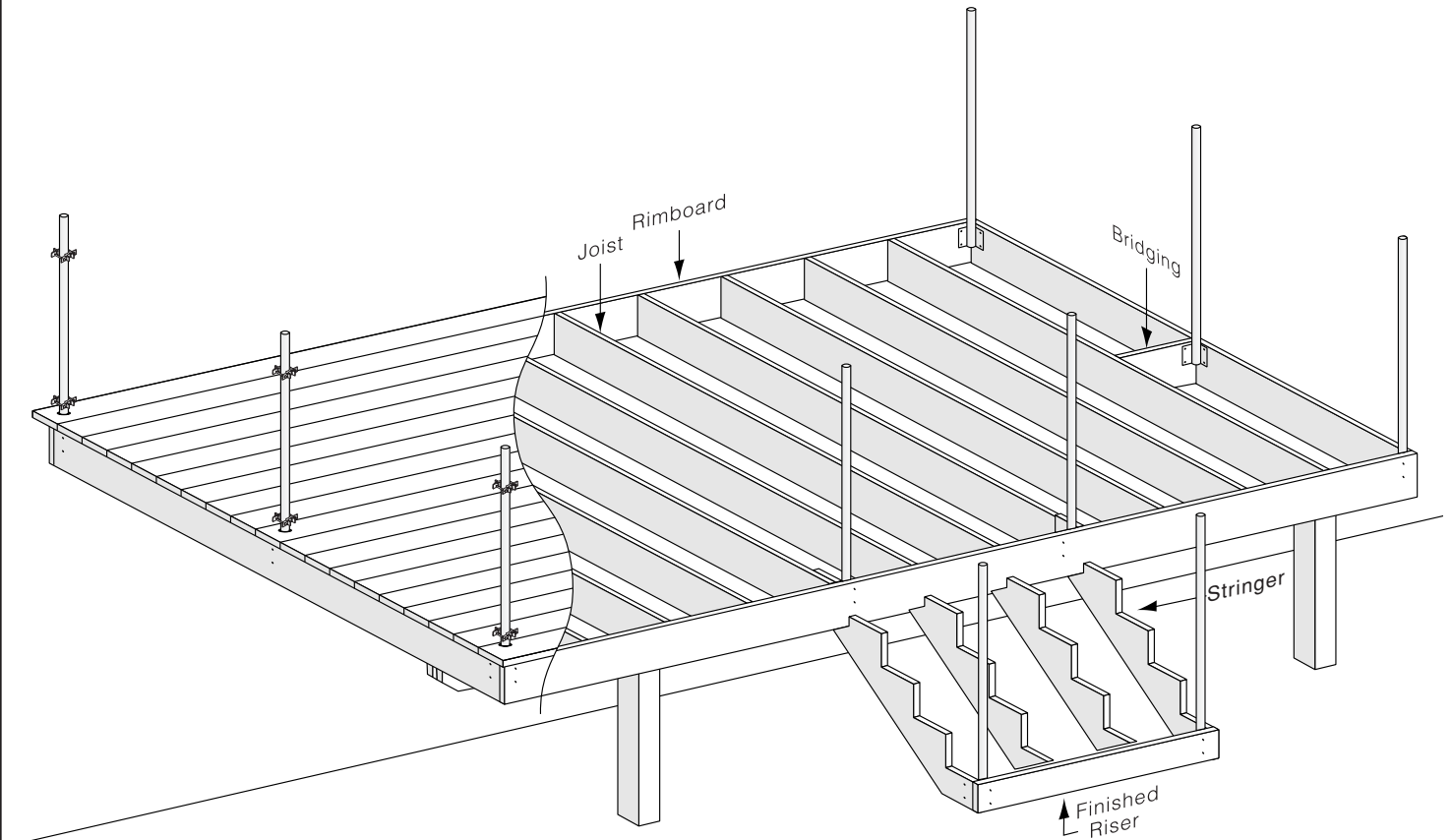

# 3. INSTALL RAILING SECTIONS

APPROVED  
CODE COMPLIANCE  
NER-605

## APPLICATION TECHNIQUES

Begin the railing project by first installing the flat sections. Complete one section at a time, working your way away from the building. The post centers may vary slightly, so cut the rails ONLY for the section you are working on. Do not fasten the rail connector plates until the entire job (flat and stair sections) is installed.

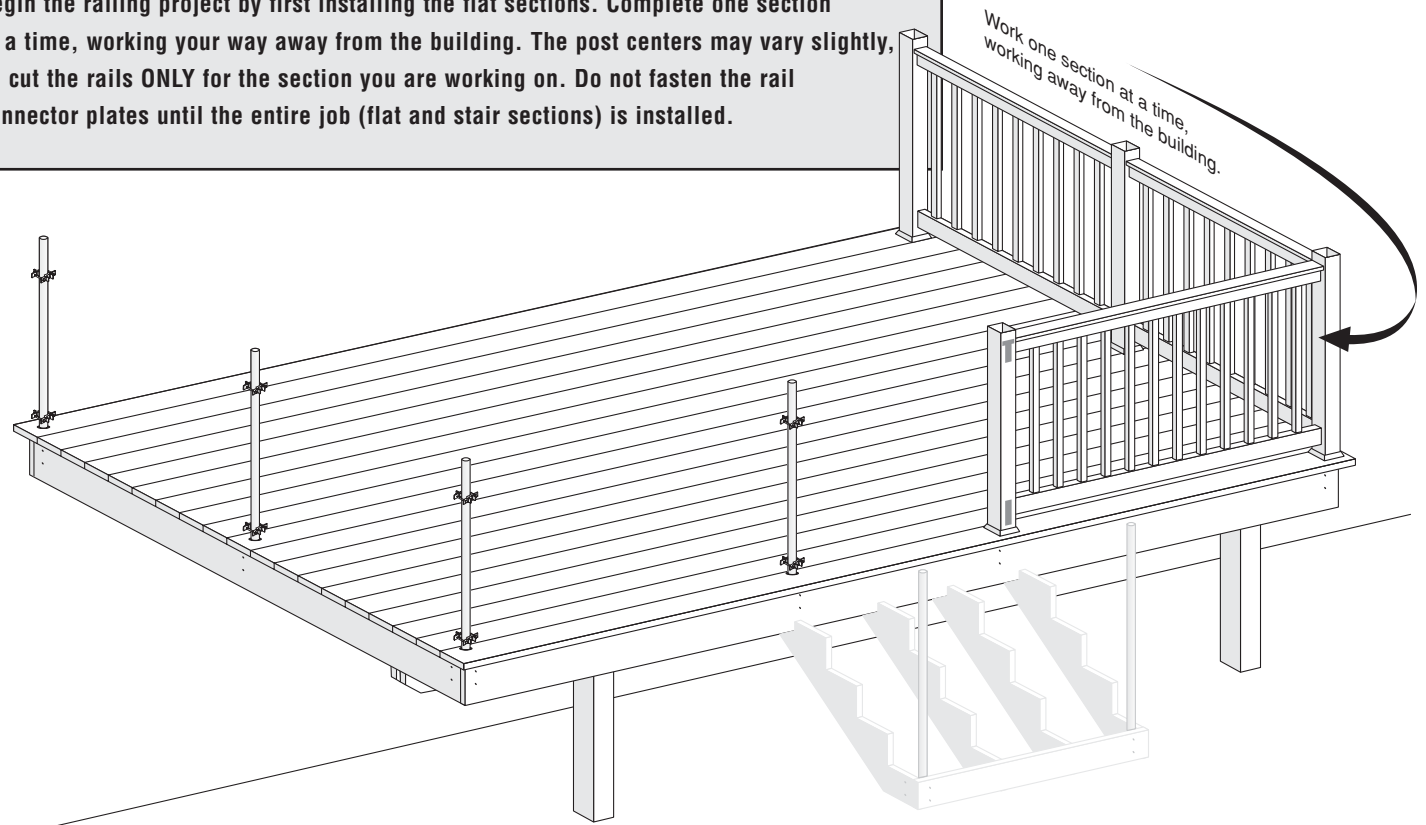

## INSTALL E-Z SET BRACKETS

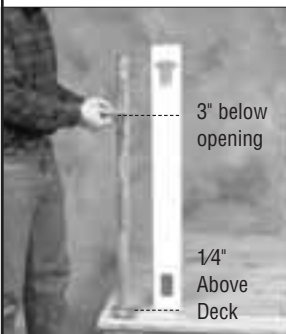

Assemble the E-Z Set brackets with the nuts and bolts provided. Stand the vinyl post up against the post support. Using the vinyl post as a guide, position one E-Z Set bracket 1/4" above the deck and the second 3" below the upper routed opening of the vinyl post. Hand tighten the brackets on the post support.



Pressing the post against the side of the brackets will help make sure they are square relative to the deck. Tighten the brackets with a wrench.



Slide the vinyl post over the brackets. If you intend to use the post trim pieces at the bottom of the post, install them now. Snap them together and slide the assembled trim down the post to the deck.

## TIP #3:

*If not a stair transition post, wait to position second E-Z Set bracket on top of the rail lock plate and top rail after the entire railing section has been assembled.*



## INSTALL RAILING SECTIONS

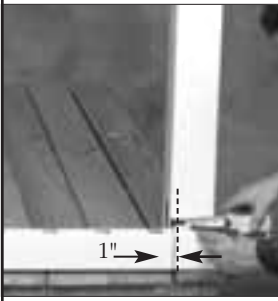

Measure the rail by laying the bottom rail between the posts with both end holes clear of the posts and equally spaced. Mark the rail 1" longer than the points where the top rail and post meet.



Cut the bottom rail, keeping the aluminum approximately 1/4" shorter than the vinyl. Use the bottom rail as a guide to cut the top rail.

To prevent interference when installing T-rail top rails on a corner post, cut off 3/4" at a 45° angle on the inside corner of each rail. Cut only the vinyl "T" portion of the rail.



Insert the bottom rail into the post.



Lift the next post and insert the rail into opening. Push the post and rail down to the deck.



### TIP #4:

*When measuring rails, mark one end of both top and bottom rails to keep them organized.*



Insert the balusters into the bottom rail.



Position the top rail over the balusters. It's easier if you rest the high end of the rail on the next post.



Pull up on the first few balusters and insert them into the top rail holes. Push down on the top rail and position it next to the opening in the post. The rail may not easily push into the post opening until you have inserted several balusters.



Once all balusters are inserted, lift the partially assembled section and insert the top rail into the post opening. Push the completed section down to the deck.

Repeat this step for all flat rail sections.

### GLASS RAILING



Use care when installing glass balusters. Insert the glass balusters into the routed holes of the bottom rail.



Position the top rail over the glass balusters. It's easier if you rest the high end of the rail on the next post.

### INSTALLING RAILING SECTIONS AT A 45° ANGLE.

Place the E-Z Set brackets over the post supports as described earlier. To accommodate the 45° angle cut of the deck, a bevel guide may be useful because each bracket will need to be rotated to a 22.5° angle on the post support. Place the vinyl post over the post support (and attach the trim pieces if you're using them). Verify the alignment. Measure and then cut the bottom rail on a 22.5° angle at each end. Use the bottom rail as a template and cut the top rail. Assemble the railing section as described earlier.

# 4. INSTALL RAIL CONNECTORS AND POST CAPS

## APPLICATION TECHNIQUES

The rails are connected to post supports only after all posts and railings have been installed. Before you connect rails to corner posts, cut 3/4" off the inside corner of each rail at a 45° angle. When connecting a stair rail to a flat section, bend the rail connector plate with pliers to accommodate the angle of the stairs.

You may prefer to install the top E-Z bracket after the connector plate has been installed.

## STEP 1C STANDARD INSTALLATION: RAIL SYSTEM ANCHOR



For added security or when using newel posts, install the top E-Z Set bracket after the rail plate. Unless at a transition post.

## STEP 1 INSTALL RAIL CONNECTORS

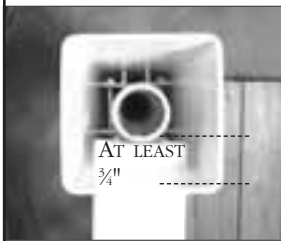

Make sure the vinyl rail and aluminum insert project 3/4" inside the post.



Insert the rail connector plate over the steel post support as shown. Drill a 3/16" hole through the rail and the aluminum insert.

Attach the plate to the rails using the hex head screws provided in the post support kit.

## STEP 1A CORNER APPLICATION



To install a rail connector on a corner post with T-rail, cut off 3/4" at a 45° angle on the inside corner of each rail. You need only cut the vinyl portion of the rail.

## STEP 1B STAIR APPLICATION



The plate has an oval cutout, so it adapts for stair angles. When moving from a flat section to a stair section, bend the plate with pliers to accommodate the angle.

## STEP 2 INSTALL POST CAPS



The internal flat cap simply snaps into the post. To install the external caps use vinyl adhesive.

# 5. BRACKET AND RAILING INSTALLATION

## INSTALLING THE BRACKETED RAILING SYSTEM

Brackets can be used on existing posts, columns, etc. directly or with a vinyl post sleeve over a 4x4 wood post. Brackets should never be connected to hollow vinyl sleeve without internal shim in post.

When using vinyl sleeve-over installation, the 4x4 wood posts must meet local building code requirements. CertainTeed is not responsible for the structural integrity of these posts.

## ALTERNATE WALL MOUNT BRACKET

ALTERNATE RAIL MOUNT SYSTEM



### METAL TO WOOD APPLICATION



Decorative slide over trim covers conceal screws and streamline the appearance.



Oxford Flat



Oxford Column  
(minimum 8" round column)



Oxford 45°



Oxford Stair

Field Cut

### CONCRETE POST APPLICATION

Vinyl posts alone do not provide adequate fastener retention. When using a steel post support kit, you must provide a wood or composite block inside posts at bracket locations for proper fastener retention.

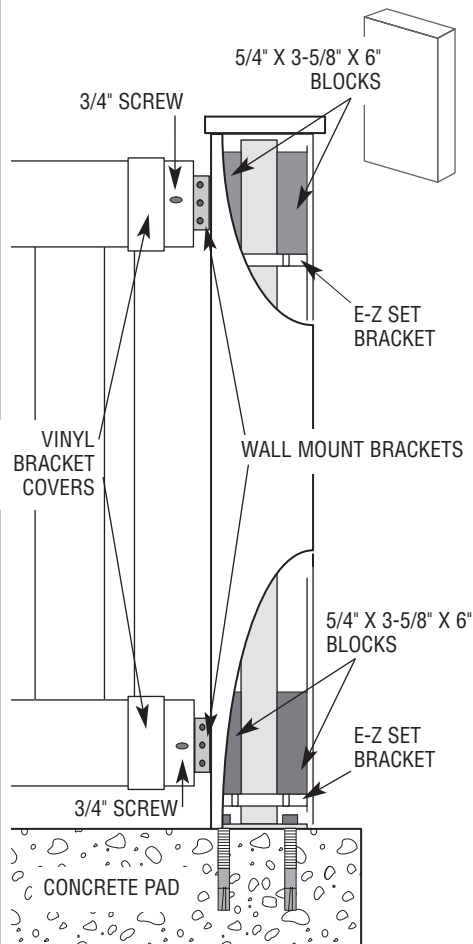

For applications under 30".

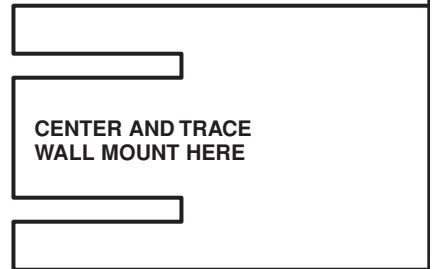

Notch one end of rail: bottom of top rail and bottom of bottom rail.

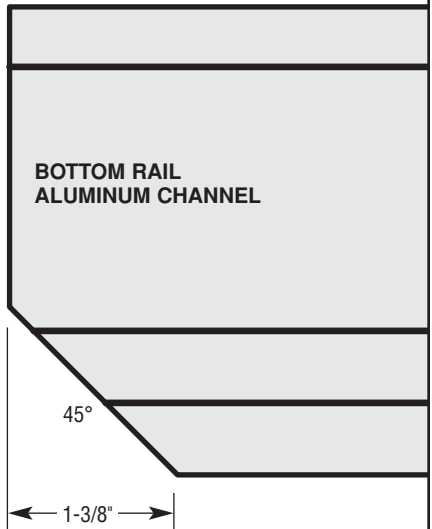

Notch bottom rail aluminum to accommodate the installation.



### TIP #5:

*If baluster interferes with bracket cover, slit the underside of the cover. Spread open and slide over railing and attach.*

## 45° BRACKET INSTALLATION

Shown is a 45° install.



Measure rails for proper length, mark and cut rails. Place cover over rail ends, insert brackets and slide rail down from the top of the post into place.

## BRACKET INSTALLATION

Shown is a full bracket install.



Measure rails for proper length and mark. Measure 1/4" back from both end marks and cut rails. Place cover over rail ends, insert brackets and slide rail into place between posts.



Pre-drill 9/64" hole for rail attachment screw.



Drill pilot hole for bracket attachment screw.



Drill pilot hole for bracket attachment screw.



Attach rail to bracket with 3/4" screw.



Attach bracket to post with screw provided. Use 4 screws per bracket.



Attach bracket to post with screw provided. Use 4 screws per bracket.



Slide cover in place, pre-drill 9/64" hole to expedite cover attachment.



Attach rail to bracket with 3/4" screw. Pre-drill 9/64" hole to expedite installation.



Attach cover to rail with 3/4" screw provided.



Slide cover in place and attach cover to rail with 3/4" screw provided. Pre-drill 9/64" hole to expedite installation.



Finish post with choice of post cap. Use vinyl adhesive for cap attachment.

### TIP #6:

*Vinyl adhesive or clear silicone adhesive can be used to attach cover to rail.*

## APPLICATION TECHNIQUES

Railings can be mounted to walls or columns using rail mount brackets. To ensure a safe installation, rail mount brackets must be anchored securely. Before mounting the railing, determine that structure is solid and that the fasteners appropriate for the structure are used.

**Important:** To ensure meeting code requirements, be sure that the space between the last baluster and the wall or post is not more than 4".

## COLUMN APPLICATION

Rail length should be measured to fit from outside edge of column. Measure and check for equal end baluster spacing between columns, at both ends of rail. Mark top/bottom rails and cut.

Slide vinyl bracket covers over both ends of bottom rail and insert aluminum brackets into both ends of rail.

Install bottom rail in between columns siding, from top, down to bottom of column, spacing bottom rail 2" off floor.

Secure aluminum brackets to column with four 2" screws (included). Fasten screws in each corner of the bracket flange.

Double check for equal end baluster spacing at columns. Secure rail to brackets with two 3/4" screws, through rail sides.

Slide vinyl cover along rail to columns and insert set screw.

To finish the section installation, insert balusters into bottom rail and then insert top rail over balusters. Repeat steps above for top rail bracket installation.

## STAIR APPLICATION

Check for equal end baluster spacing on both sides. Mark rail where it intersects post. Measure back 1/4" from lines and cut railing.

Foam is included to secure cover while cutting. Cut vinyl covers to stair angle and then slide over both ends of rail.

Double check for equal end baluster spacing. Secure rail to bracket with two 3/4" screws through rail sides.

Slide vinyl cover along rail to post and insert set screw.

To finish the section installation, insert balusters into bottom rail and then insert top rail over balusters.

## TIP #7:

**When securing bracket to post, drill pilot hole with a 9/64" drill bit to prevent bracket from sliding.**

Insert aluminum bracket into both ends of rail. Check correct position by sliding vinyl cover over bracket for fit.

Secure rail and bracket to post with four 2" screws (included). Fasten screws in each corner of the bracket flange.

Repeat steps above for top rail bracket installation.

Note: Brackets can be field cut to avoid baluster interference.

## 22.5° APPLICATION



Use stair bracket kit.

Cut 4 22.5° shims from a wood or composite 4x4 post.

Cut rails to length.

Cut stair covers at 22.5°.



Place shims between post/brackets and install bottom rail. Before securing bracket in post, always check the alignment of cover for possible adjustments.

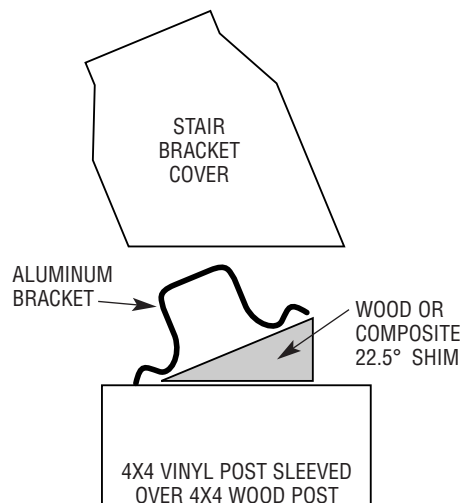

## COLUMN STAIR APPLICATION



Use stair bracket kit.

Cut degree of angle of stairway to cover.

Place cover against column. Trace radius to top and bottom of cover.

Cut and install.

# 6. INSTALL STAIR RAILING

## APPLICATION TECHNIQUES

When planning for steps, be sure that the top step of the stairs is lower than the deck surface because if you extend the deck as the top step, the angle will be too steep to attach the railing as a standard installation and will require an additional post. Also, check that the length of the rail will extend between the top and bottom post supports. If it doesn't, you will need to add an intermediate stair line post.

CertainTeed posts and rails are cut and routed for stairs built at the standard 32° angle, but they can be used for stairs from 27° to 35°. If the stairs will be other than the standard 7" rise/11" run (32°), you may have to shorten the balusters and enlarge the pre-routed holes in the rails and posts. For small modifications, you can use a file. For more substantial changes to the posts, we suggest you use a jigsaw or router and our Post Routing Template Kit.

CertainTeed also offers rails cut and routed for stairs with steeper angles up to 42°. If you are building a handicap ramp, you should be able to use a standard flat rail and flat post without having to field-route the holes if you build it according to ADA code.

## OPTIONAL TOOLS

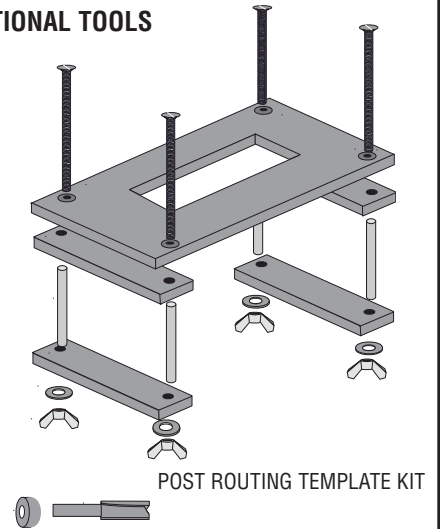

## STEP 1 INSTALL BOTTOM POST SUPPORT AND POST



Begin the stair section by installing the stair post support and E-Z Set brackets. Do not cut the support posts yet.



Slide the vinyl post over the support post—do not cut the vinyl post either.

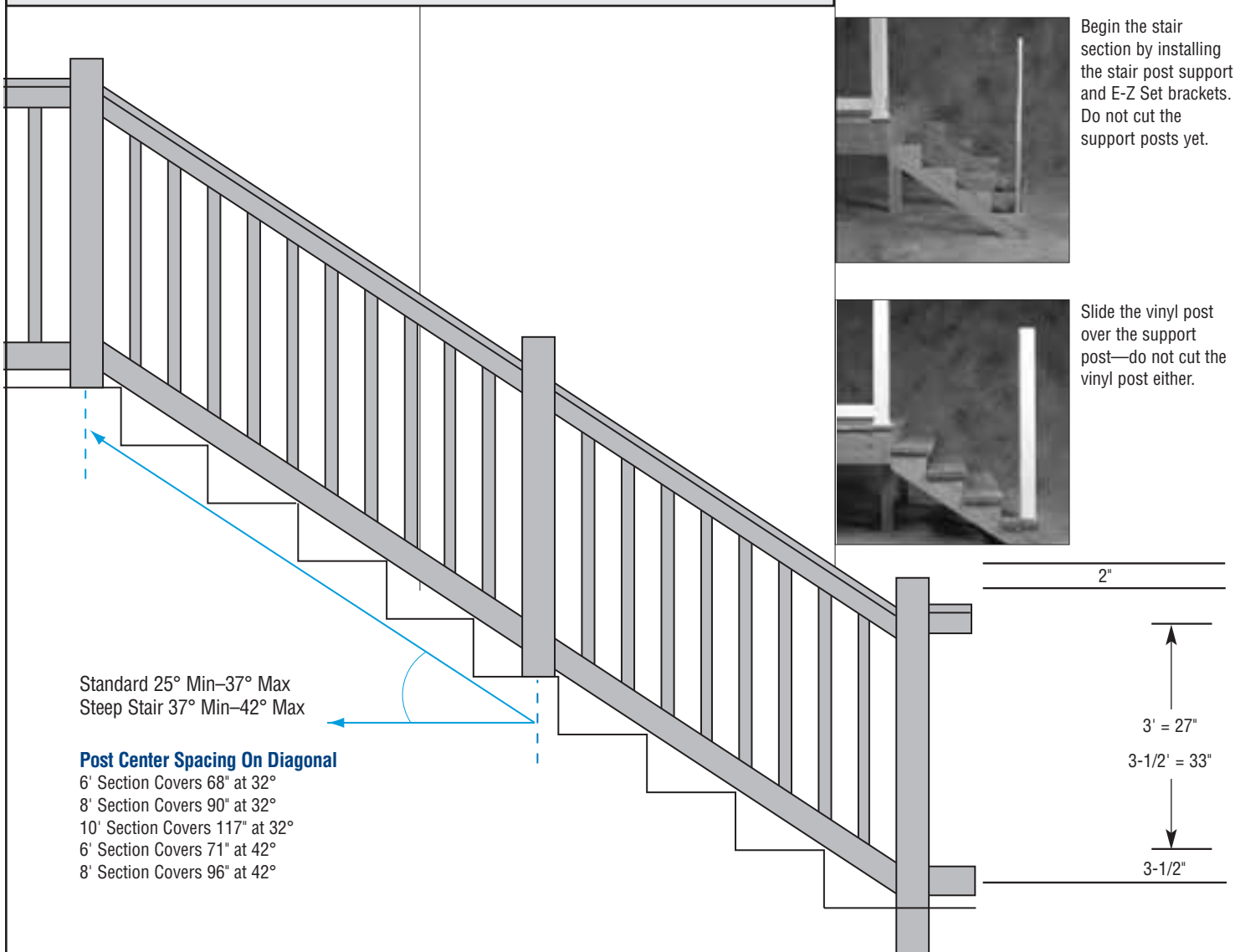

Standard 25° Min–37° Max  
Steep Stair 37° Min–42° Max

### Post Center Spacing On Diagonal

- 6' Section Covers 68" at 32°
- 8' Section Covers 90" at 32°
- 10' Section Covers 117" at 32°
- 6' Section Covers 71" at 42°
- 8' Section Covers 96" at 42°

## STEP 2 CUT BOTTOM STAIR POST AND POST SUPPORT



Insert the bottom rail into upper post. Clamp the rail to the lower post at the desired height and angle. Measure the distance from the point where the rail and post meet to the stair tread.

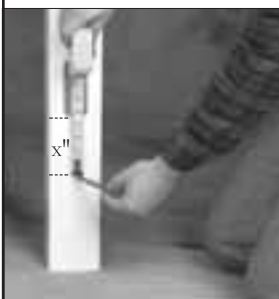

Remove the lower post and transfer your previous measurement as shown.



Cut the post along your mark.

Use the previously cut stair post as a guide to determine the post support height. Place the stair post on the step next to the steel post support. Mark the support at 34" above the top rail opening. Cut off the post support at your mark. Cover any exposed vinyl components that could be damaged by falling cut-offs.

## STEP 3 CUT THE RAIL-TO-STAIR ANGLE AND LENGTH



Lay the bottom rail between the posts, with the end holes clear of the posts and equally spaced. Align the rail with the top of the rail on each post. Measure the rail.

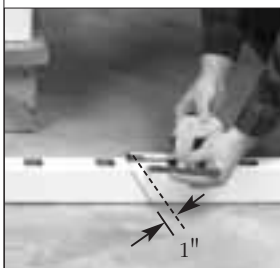

Mark vertical lines on both ends of the rail where it meets the posts. Measure over 1" along the angle on both ends of the rail to allow for the extra length inserted into the post. Remark the rail for the cut line.



Cut the stair rail to the exact angle that you traced. Make sure the aluminum rail insert is 1/4" shorter than the end of the vinyl rail.

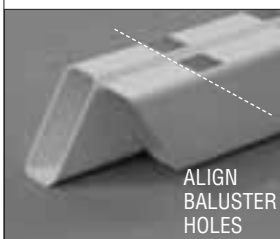

Use bottom rail as a guide and line up baluster holes to top rail. Mark degree of stair angle to top rail, in the opposite direction of the bottom rail, and cut.

## STEP 4 ASSEMBLE STAIR RAIL SECTION



To assemble the rail sections, slide the post over the post support. Insert the bottom rail into the lower post. You may find it easier to lift the lower post, insert the bottom rail, and then lower the post.



Lift the upper post 3-4" until you can insert the bottom rail. Then slide the post and rail back down.



Insert the balusters into the bottom rail. Insert the balusters into the top rail; then insert the top rail into the lower post. You may find it easier to work from the bottom stair up to top.

### GLASS STAIR RAILING



Use care when installing glass balusters. Insert glass balusters the same way. To fit properly, the angle cut on the glass baluster needs to be installed in the same direction as the stair angle.



Lift the partially assembled section and insert the top rail into the opening. Push the section down to the deck.

# 7. SOCKET GATE INSTALLATION

## APPLICATION TECHNIQUES

- Allow an additional 1-3/4" to gate opening to accommodate hinge and latch.
- Determine if you need a regular or opposite gate. Latches should always be mounted on same face of gate as the hinges.
- Gate kits are supplied with gate posts, diagonal brace, mounting hardware and instructions. An additional Gate Rail Kit (2x4 top and bottom rail) and balusters will be needed to complete installation.

## MAGNA LATCH

To be used for additional safety to meet swimming pool codes.

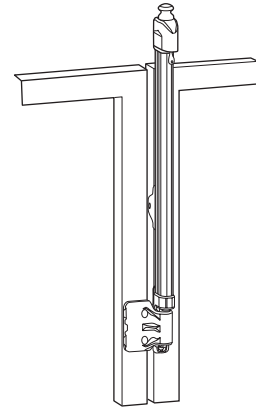

## REGULAR GATE

(viewed from the inside)

Brace is located on the inside of the gate.

Gate is hinged on the left and latched on the right.

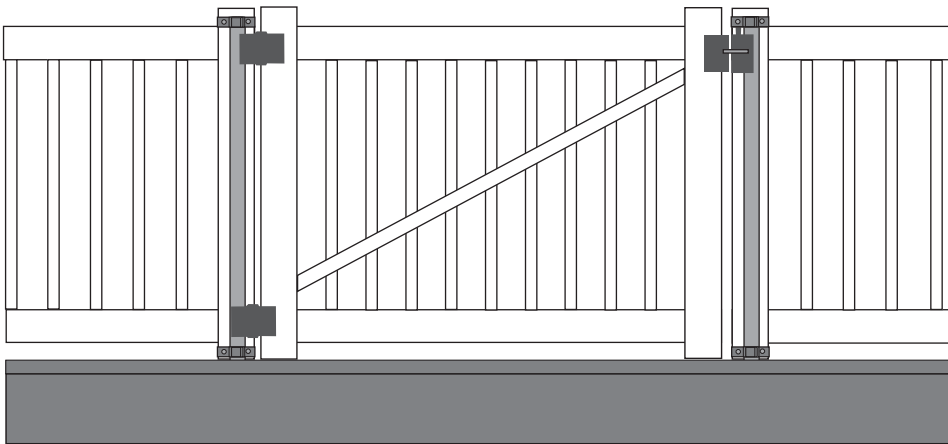

## OPPOSITE GATE

(viewed from the inside)

Brace is located on the inside of the gate.

Gate is hinged on the right and latched on the left.

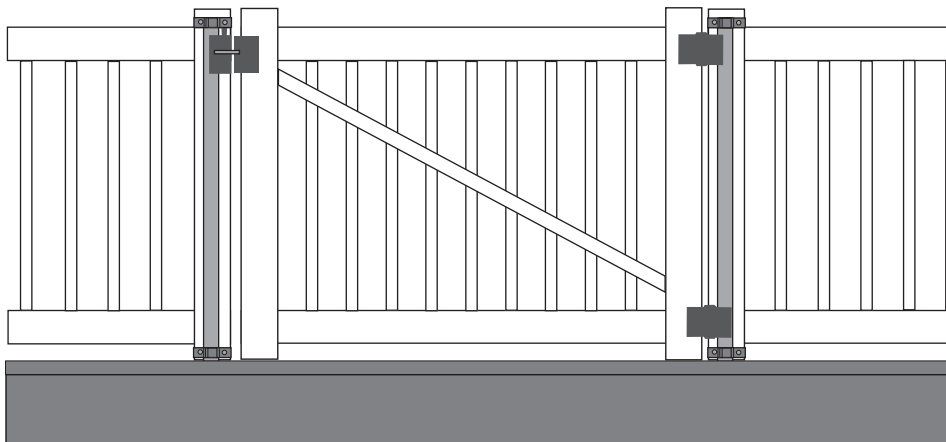

CertainTeed does not recommend double gates in deck applications.

# CARE AND MAINTENANCE

## CARE & MAINTENANCE

Exterior vinyl building materials require very little maintenance. Nevertheless, common sense dictates that builders and suppliers of vinyl products store, handle, and install vinyl materials in a manner that avoids damage to the product or structure.

CertainTeed deck and railing is not difficult to work with, but there are a few precautions that you should know about before you begin to unload and install the product. Always place planks, posts, rails, and accessories on a non-abrasive surface, such as a drop cloth or cardboard, to avoid scratches. Protect all components during transport. Finally, when assembling the deck and railing, avoid over-tightening the screws.

## CLEANING

CertainTeed vinyl deck and railing resists most common household stains, including oil and grease. But, like any other product, it will get dirty when it is exposed to the atmosphere. Chalk may also accumulate on the surface. This is a normal condition for all pigmented materials that are constantly exposed to sunlight and the elements. Soil, grime, and chalk can be removed with a garden hose and a bucket of soapy water.

In some areas, mildew may be a problem. Mildew appears as black spots on surface dirt and is usually first detected in areas not subjected to rainfall, such as eaves and porch enclosures. You can remove mildew from vinyl deck and railing with the solution below. CAUTION: CLEANING SOLUTION MIXED AT GREATER CONCENTRATIONS MAY HARM THE VINYL.

Mix together:

- 1/3 cup detergent (Tide, for example)
- 2/3 cup trisodium phosphate (Soilex, for example)
- 1 qt. 5% sodium hypochlorite (Clorox, for example)
- 3 qt. water

If the above solution does not readily remove the mildew spots, purchase a mildew cleaner from your local hardware store. Before you use any commercial cleaner, test it on an inconspicuous area.

The chemical agents mentioned above may be hazardous to the user or to the environment. Be sure to follow all precautions and warnings on the product label, particularly those that may be necessary to prevent personal injury. Please DISCARD these chemical agents in the manner prescribed by the manufacturer. If you are unsure how to use or dispose of these chemical agents, contact the manufacturer.

## IMPORTANT! FIRE INFORMATION

**Rigid vinyl deck and railing are made from organic materials that will not burn on their own but melt or burn when exposed to a significant source of flame or heat. Consequently, owners and installers should take a few simple steps to protect vinyl building materials from fire. Building owners, occupants, and outside maintenance personnel should always take normal precaution to keep sources of fire, such as barbecues, and combustible materials, like dry leaves, mulch and trash, away from vinyl deck and railing.**

# EverNew®

## Vinyl Railing & Deck Systems

CertainTeed Sales Support Group  
P.O. Box 860 • Valley Forge, PA 19482  
(800) 233-8990 • Fax: (610) 341-7940  
[www.certainteed.com](http://www.certainteed.com)