

# SINGLE MAINE BOARD RAIL GATE (4 FOOT WIDE 46" HIGH GATE) CENTRAL EYE HINGES (Product Codes #8312) GATE HUNG BETWEEN POSTS

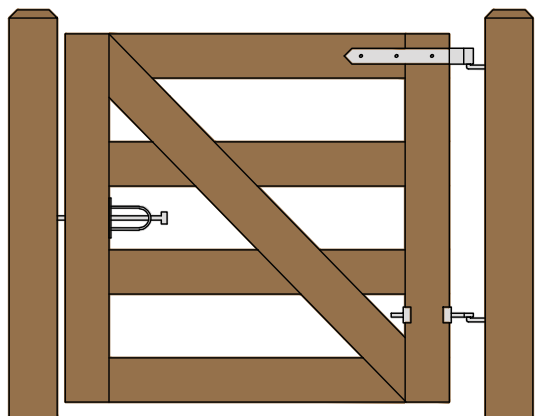

Distance between latch post and gate	A
Width of Gate	B
Distance between gate and hinge post	C
Total distance between posts	D

Hardware Required						
	<b>Galvanized Finish</b>	<b>Black Powder Coat over Galvanized Finish</b>	<b>Central Eye Hinge Advantages</b>  Opens both ways 100 degrees Incredible amount of adjustment Easy operation Very strong			
Hinge Set	8312-S122	8312-S12P				
fasteners included with hardware	Set Includes one 12 inch double strap (8312-422 or 8312-42SP) one adjustable bottom gate fitting (8250-002 or 8250-00P) two 12" adjustable gate pin (8800-122 or 8800-12P)					
Latch Options			Dimensions (feet and inches)			
			A	B	C	D
Irish Gate Latch (shown above)	8328-002	8328-00SP	1"	4'	4.5"	4' 5.5"
Spring Latch	8327-002	8327-00P	4"	4'	4.5"	4' 9.5"
Cane Bolt and Keep	5000-122 plus 5000-002	5000-12SP plus 5000-00SP	1"	4'	4.5"	4' 5.5"
Lumber Required						
Posts	2 of 8' x 6" x6" (usually dressed out at 5.5" x 5.5")					
Rails, Stiles (uprights) and Diagonals made from full 1" thick by 5.5" wide lumber (commonly stocked decking material or rough cut lumber)						
Rails	3 of 8' x 1" x 5.5"					
Stiles	2 of 8' x 1" x 5.5"					
Diagonals	1 of 10' x 1" x 5.5"					
Fasteners Required						
Approximately 50 of 1.75" x #8 wood screws (stainless preferred)						
14 of 3.5" x 3/8" carriage bolts (hot dipped galvanized or stainless steel), nuts, and washers						
Use a 24" Cane Bolt (5000-242 or 5000-24SP) if you require a means of keeping the gate open						

## Hoover Fence Company

**Download includes this materials list, component cutting and layout sheet, tips on installing gate posts, and detailed instructions.  
For a complete listing of our free gate plans and gate layouts visit [hooverfence.com](http://hooverfence.com).**

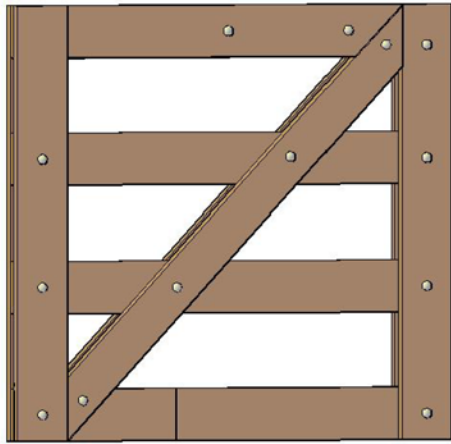

**FLAT FRONTAL VIEW**

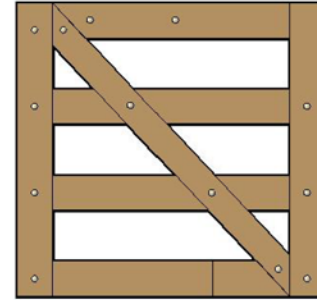

**THREE LAYERS**

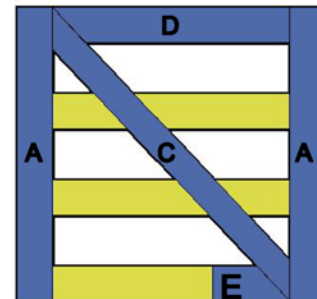
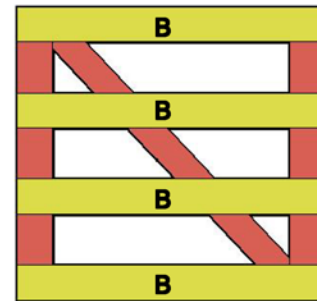
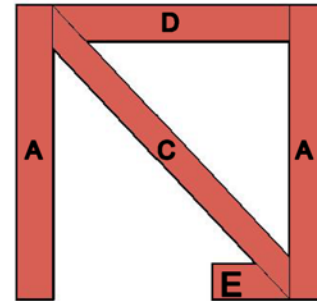

**COMPONENTS (FULL 1" THICK x 5-1/2" WIDE)**

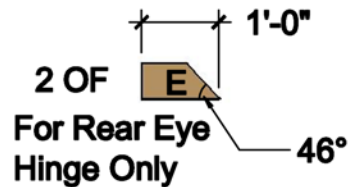
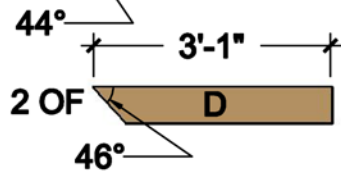
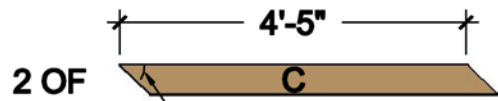
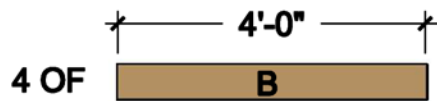
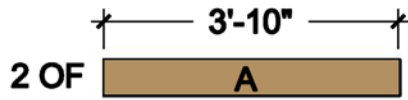

**Hoover Fence  
4' Maine Board Gate**