

SIDE

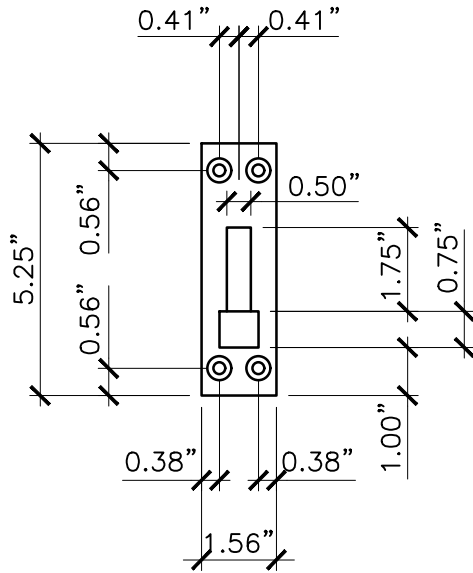

FRONT

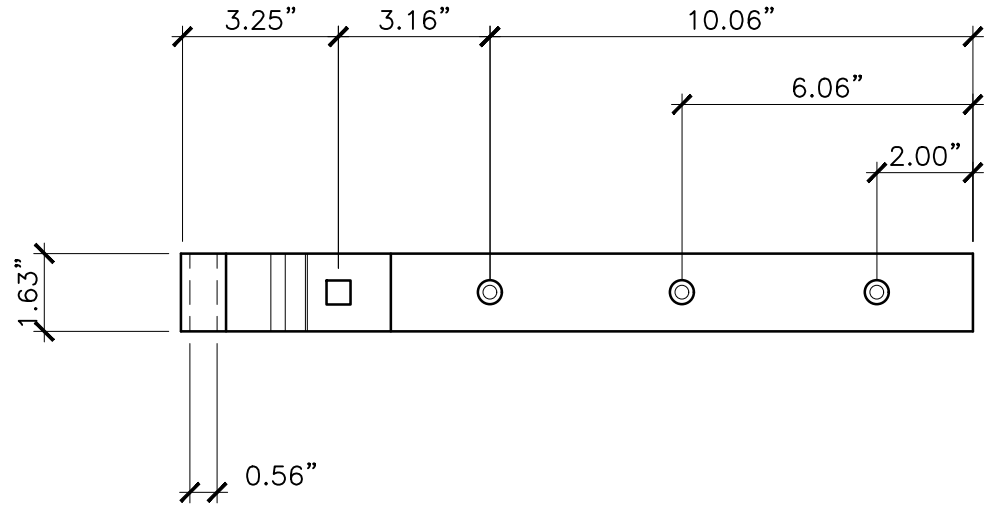

FRONT

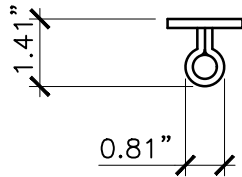

TOP

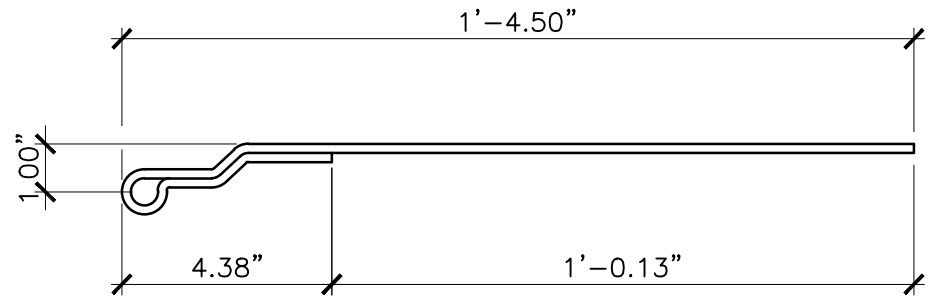

TOP

<p>PROPERTY OF:</p> 	<p>PRODUCT DESCRIPTION:</p> <p>16" CONTEMPORARY CRANKED BAND HINGES</p> <p>ALL DIMENSIONS ±0.125"</p>	<p>PART NUMBER:</p> <p>6295</p>
---	---	---------------------------------