

6' Concrete Mount Specifications

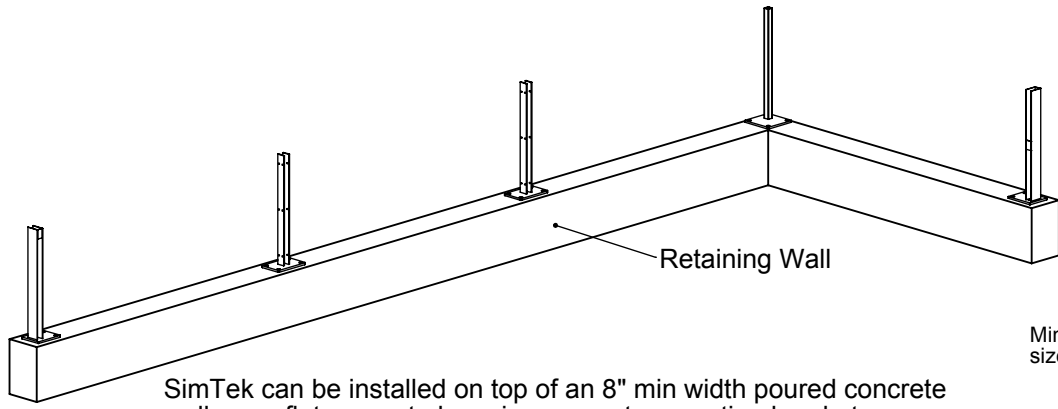

Minimum Bolt size 1/2" x 4.5"

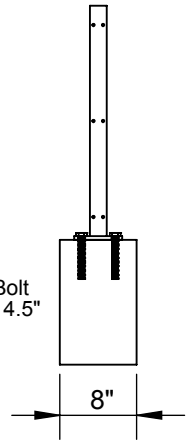

Use epoxy anchors instead of wedge anchors for gate shoe

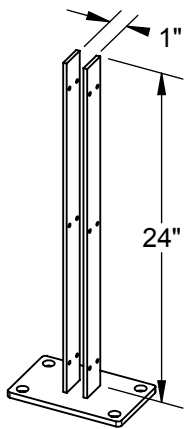

Line Shoe

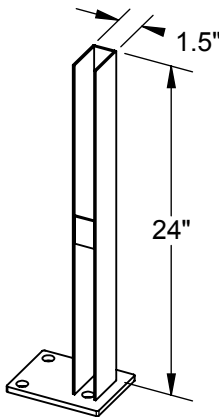

End Shoe

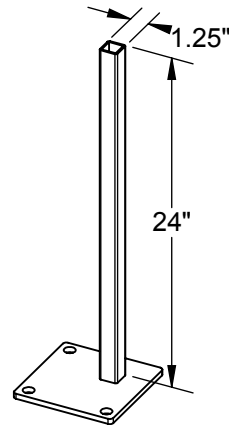

Corner Shoe

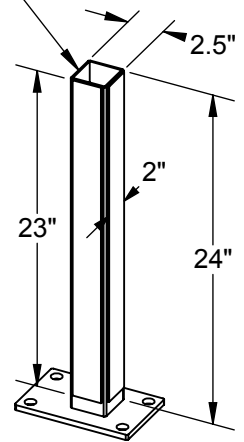

Gate Shoe

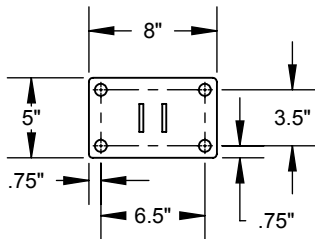

Line Shoe Skirt

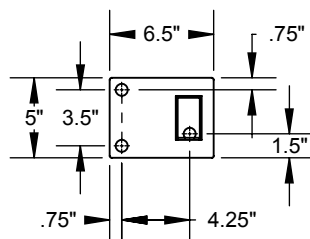

End Shoe Skirt

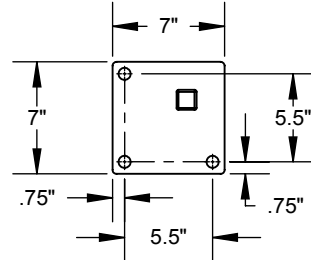

Corner Shoe Skirt

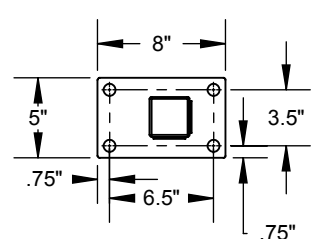

Gate Shoe Skirt

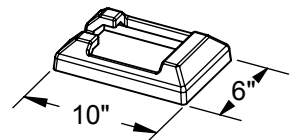
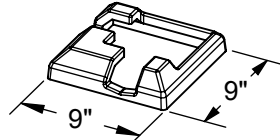
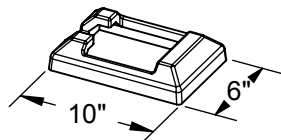
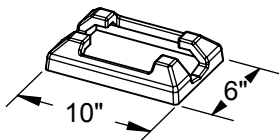

Surface Mount Specs

This drawing may not be altered or reproduced without the permission of SimTek[®] Fence

Date: Jun 24, 2014

Scale: not to scale

REV: D Barlocker

Sheet 1 of 1

U.S. Patents: 7,478,797 / 7,635,114 Foreign Patents Pending



www.simtekfence.com