

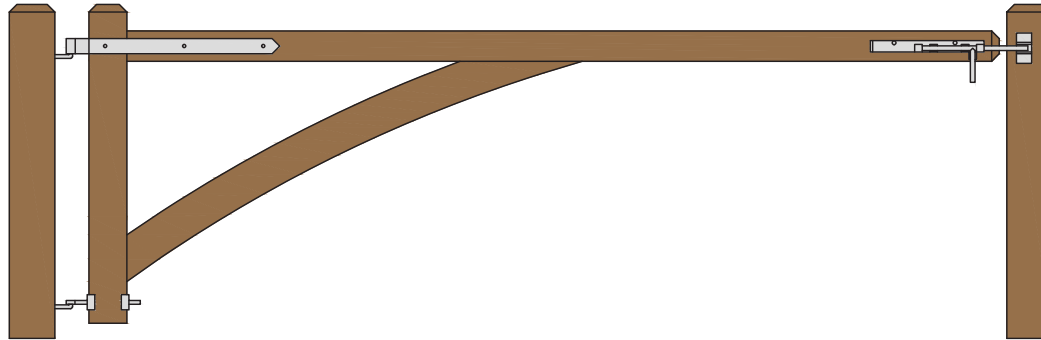

WELDON BARRIER GATE PLAN

Single Gate Configuration - Curved Support Design

10' wide by 44" tall gate - hung between the posts - using Central Eye Hinges
(Product Code #8312).



Distance between latch post and gate	A
Width of Gate	B
Distance between gate and hinge post	C
Total distance between posts	D

HARDWARE REQUIRED						
Finish Options Available	Galvanized Finish	Black Powder Coat over Galvanized Finish	Central Eye Hinge Advantages Opens both ways 100 degrees. Incredible amount of adjustment. Easy operation. Very strong.			
Plan Specified Hinge Set						
Each Set Includes: (All fasteners are included with hardware)	8312-S242	8312-S24P				
	one 24 inch double strap (8312-542 or 8312-54SP) one adjustable bottom gate fitting (8250-002 or 8250-00P) two 12" adjustable gate pins (8801-122 or 8801-12P)					
Latch Options			Dimensions (feet and inches)			
			A	B	C	D
Slide Bolt Latch (shown)	5002-L122	5002-L12SP	1"	10'	4.5"	10' - 5.5"
Quick Catch	4100-3SS	4100-3BSS	1.5"	10'	4.5"	10' - 6"
Throw Over Gate Loop*	4200-032	4200-03SP	5"	10'	4.5"	10' - 9.5"
Optional Gate Holdback			A means of keeping gate open			
Heavy Duty Cabin Hook	4270-122	4270-12SP				
Lumber Required			Rails, Stiles (uprights) and Diagonals made from full 1" thick by 5.5" wide lumber (commonly sold as decking lumber) or 1" rough cut lumber (4/4).			
Posts	2 of 8' x 6" x 6" (usually dressed out at 5.5" x 5.5")					
Rails	3 of 10' x 1" x 5.5"					
Stiles	2 of 8' x 1" x 5.5"					
Diagonals	1 of 8' x 1" x 5.5" (straight support design) or 2 of 8' x 1" x 5.5" (curved support design)					
Filler Blocks	use off cuts from above					
Fasteners Required for Gate Construction						
FP-WeldonBarr. - Fastener Pack for Weldon Barrier Gate Build (Includes 40 of 1.75" wood screws, 2 of 3/8" dowel rod and 9 of 3.5" HDG carriage bolts, nuts and washers)						
*Using the Throw Over Gate Loop (4200-032 or 4200-03SP) will require you to build a receiver for the latch onto the latch post.						

Download includes this materials list, component cutting and layout sheet.
For a complete listing of our Free Gate Plans, please visit snugcottagehardware.com

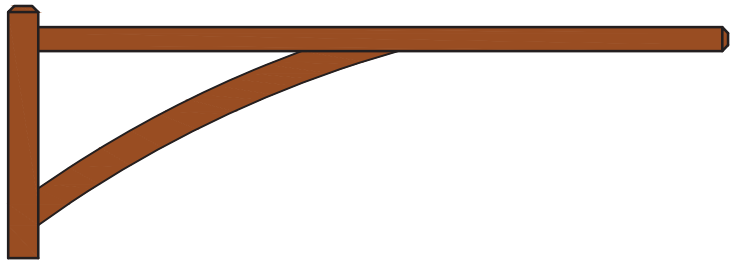

8' CURVED BARRIER GATE

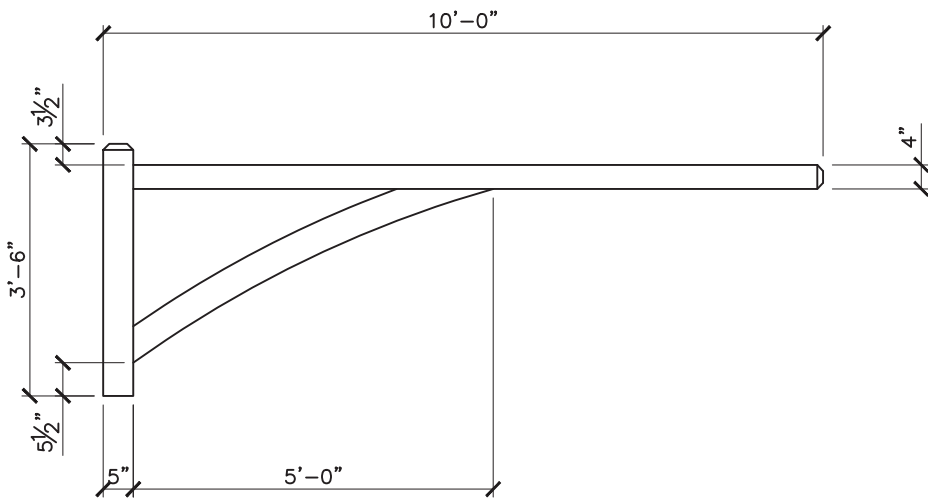

GATE DIMENSIONS

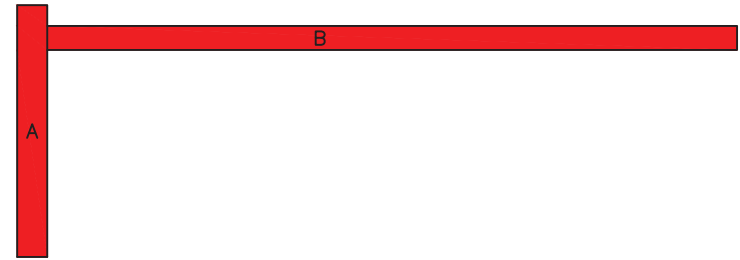

FIRST LAYER

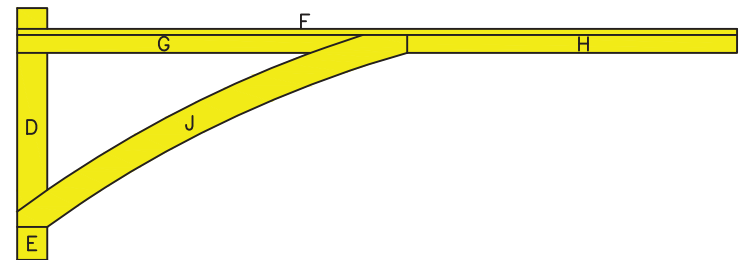

SECOND LAYER

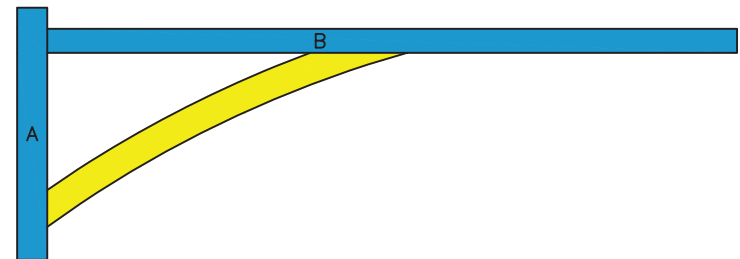

THIRD LAYER

BUILDING STEPS

PROPERTY OF:



PRODUCT DESCRIPTION:

10' WELDON BARRIER GATE
CURVED SUPPORT DESIGN

ALL DIMENSIONS $\pm 0.125"$

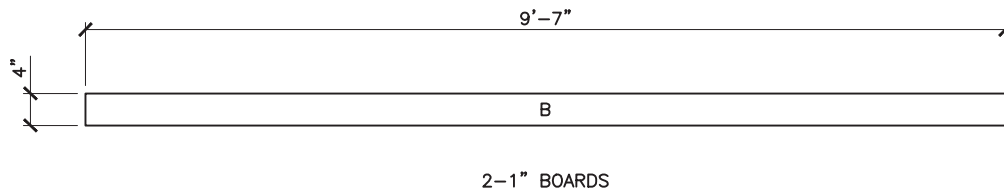
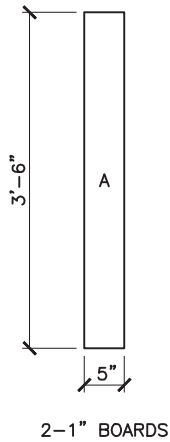

FIRST AND THIRD LAYER COMPONENTS

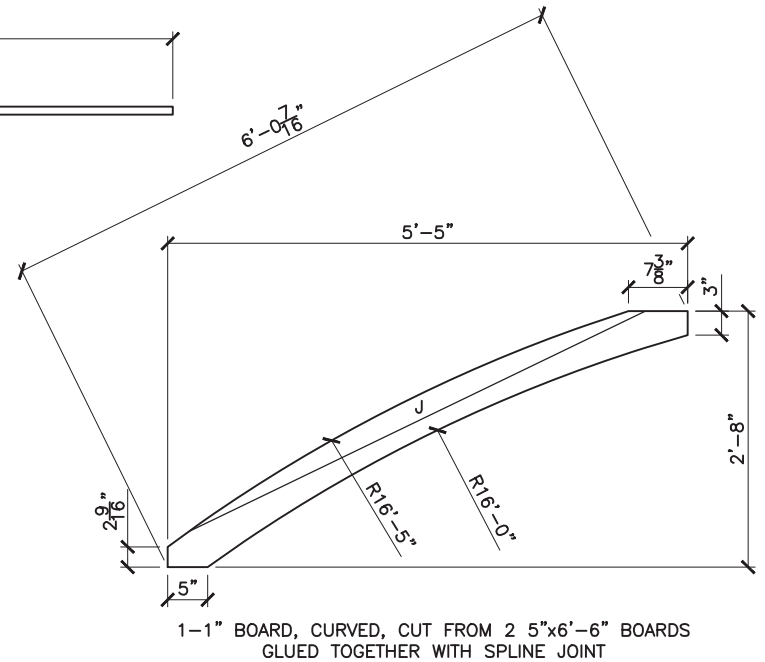
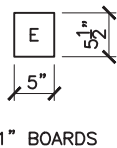
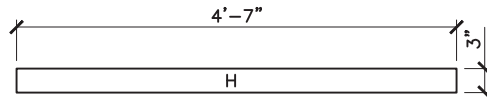
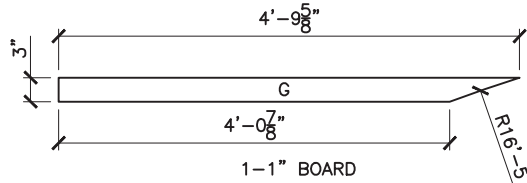
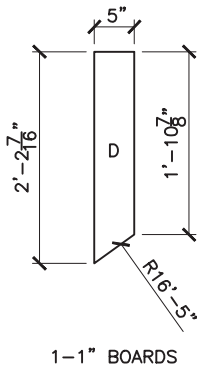
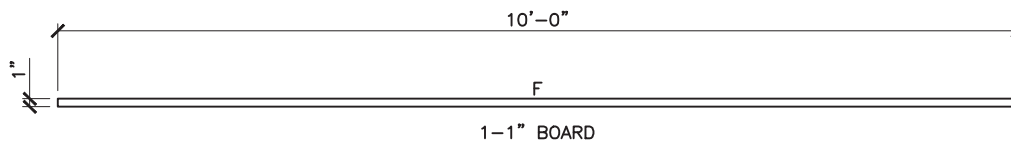
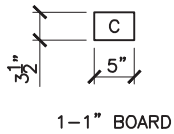

SECOND LAYER COMPONENTS

PROPERTY OF:



PRODUCT DESCRIPTION:

10' WELDON BARRIER GATE CURVED SUPPORT DESIGN COMPONENTS

ALL DIMENSIONS ±0.125"