

PROPERTY OF: SNUG COTTAGE HARDWARE LLC MARYSVILLE MI. 48040	PRODUCT DESCRIPTION: 18" REAR EYE DOUBLE STRAP HINGE – 3" BETWEEN STRAPS ALL DIMENSIONS ±0.125"	PART NUMBER: 8324-182/18SP
---	---	-------------------------------

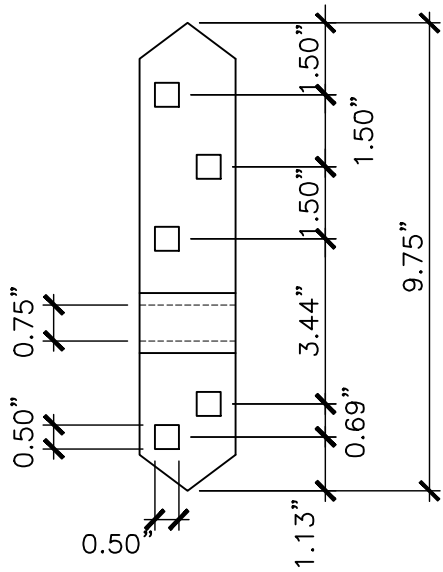

FRONT



TOP

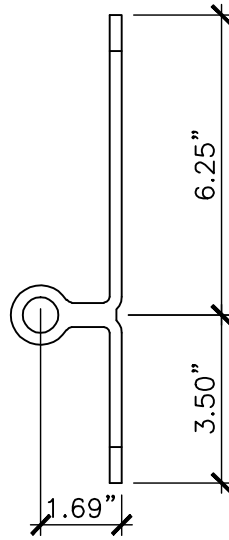

SIDE

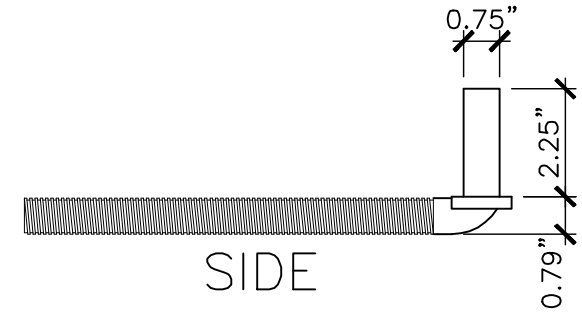

SIDE

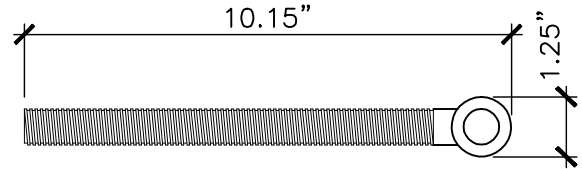

TOP

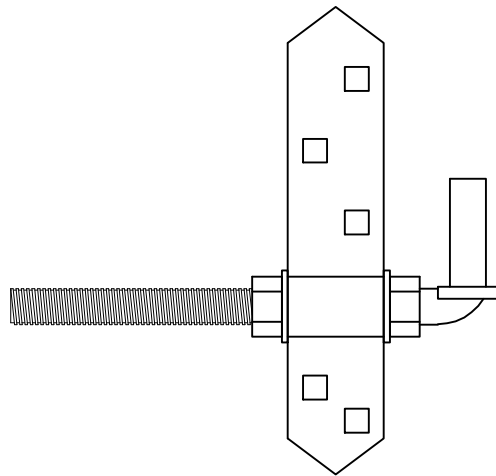

FRONT ASSEMBLED

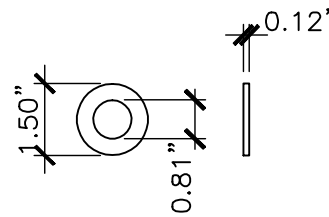

WASHER X2

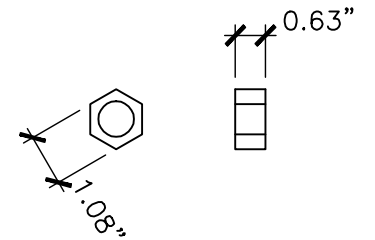

NUT X2

PROPERTY OF:  
 SNUG COTTAGE  
 HARDWARE LLC  
 MARYSVILLE MI.  
 48040

PRODUCT DESCRIPTION:  
 3/4" MOUNTING PLATE WITH 8" ADJUSTABLE PIN  
 ALL DIMENSIONS  $\pm 0.125"$

PART NUMBER:  
 8256-342/34P