

"INSTALLATION INSTRUCTIONS OF DIGITAL DOOR LOCK"

NO. 2210 (Built-In type Deadbolt Lock with "Throw of Bolt: 25.4mm (1")")

I. THE NAME AND DETAILS OF THE ENCLOSED PARTS

NO.	name of parts	NO. 2210
1.	outside body	1 pce
2.	inside body	1 pce
3.	rubber escutcheon	2 pcs
4.	mortised strike	1 pce
5.	spindle for 40-55mm (1.37/64"-2.11/64")	1 pce
6.	spindle for 30-45mm (1.3/16"-1.49/64")	1 pce
7.	machine screw M4 x 1.31/32" for above 5	2 pcs
8.	machine screw M4 x 1.3/8" for above 6	2 pcs
9.	wood screw M4 x 5/8"	4 pcs
10.	key tumbler (red)	1 pce
11.	keyless tumbler (blue)	1 pce
12.	deadbolt unit	1 pce
13.	tweezers	1 pce

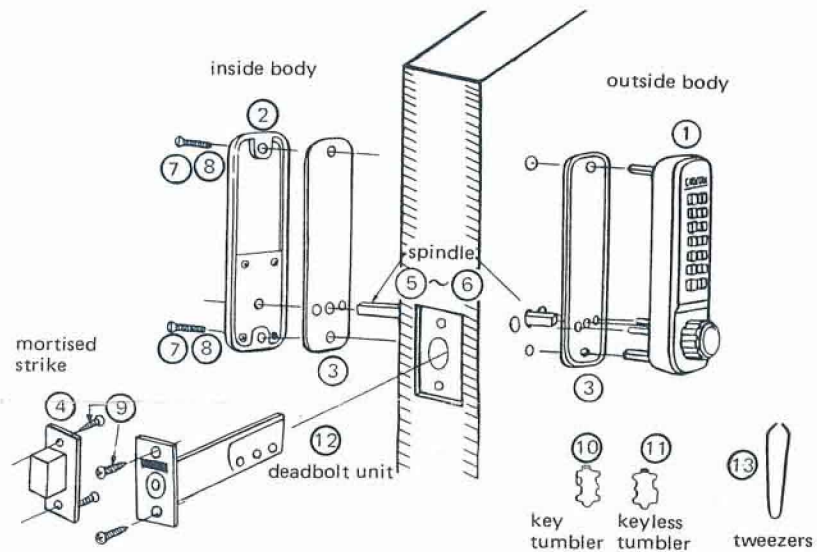

II. CONFIRM THE POSITION OF HINGE BEFORE INSTALLATION

DIGITAL DOOR LOCK is equipped with "FOR RIGHT HAND DOOR" which the hinge is installed on the right of the door on the sight from the out-door regardless of the opening direction of the door, as shown in Fig. 1.

Fig. 1 FOR RIGHT HAND DOOR

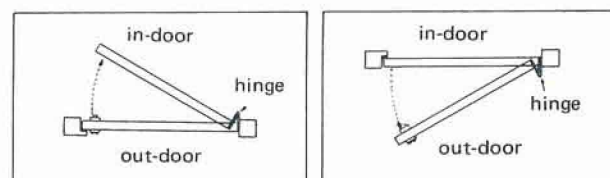

●●● In case of "FOR LEFT HAND DOOR", change the PIN as the following explanation. ●●●

- Remove 2 blue colored screws by the driver and take off the rectangular lid.
- After pulling up the PIN by the supplied tweezers, insert it into the right hole sufficiently. (as Fig. 2.)
- Reset the lid with 2 blue colored screws.

Fig. 2

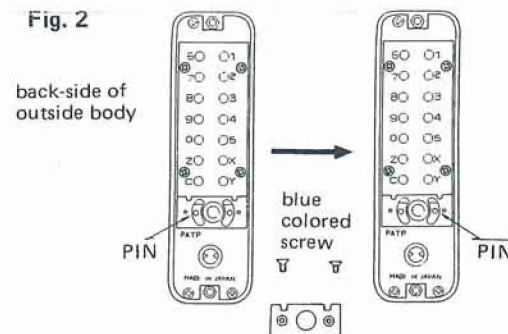

III. HOW TO INSTALL THE DIGITAL DOOR LOCK

- Use a template at first and decide the position where DIGITAL DOOR LOCK is to be installed.
- Drill holes as per template.

Fig. 3

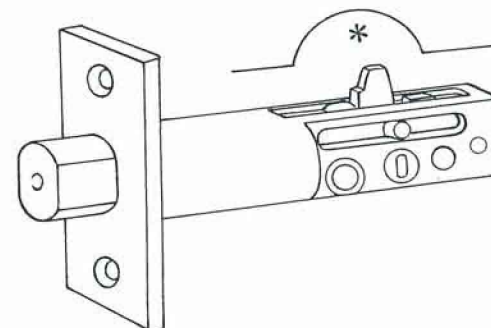

IMPORTANT

You must ensure that inside of 22mm (55/64") mortise hole is enlarged by moving wood drill up and down or using a small chisel - This is to give clearance for movement of "CAM" which moves up as deadbolt is thrown (as shown in diagram*) (Fig. 3) - check clearance required by turning spindle in deadbolt and view movement of CAM.

Fig. 4

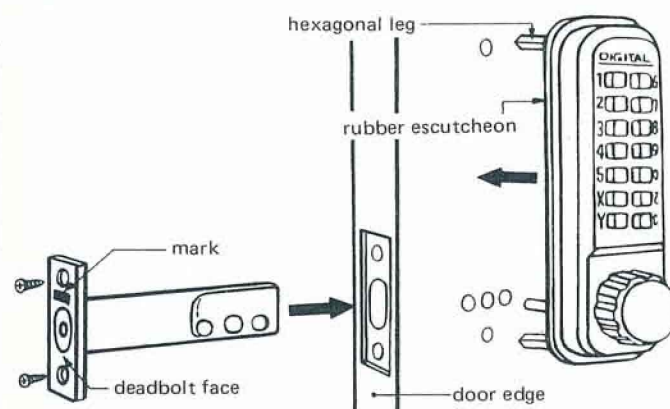

- After placing the Rubber Escutcheon to the back-side of outside body, insert 2 hexagonal legs of the outside body into the holes of upper and lower position on the door. (See Fig. 4.)

- d. According to the door thickness, select the proper spindle. And insert it into the hole which is located at the back-side of outside body through the hole of Deadbolt Unit from the indoor side.

Door thickness from 40mm (1.37/64") to 55mm (2.11/64") 86mm (3.25/64") length spindle (part No. 5)

Door thickness from 30mm (1.3/16") to 45mm (1.49/64") 76mm (2.63/64") length spindle (part No. 6)

(The indicated size on the Spindle is the applicable door thickness)

- e. After placing the Rubber Escutcheon to the back-side of inside body, install it to the door. (Refer Fig. 5.)
 (The spindle should be inserted to the Spindle Hole of inside body.)
 (The Spot is marked on the knob of inside body should be suited with either spot is marked on the surface of inside body.)
- f. Fasten the inside body with the machine screws of the supplied proper length. (part No. 7-8)
- g. Check the operation of the deadbolt by turning the inside and outside knob.

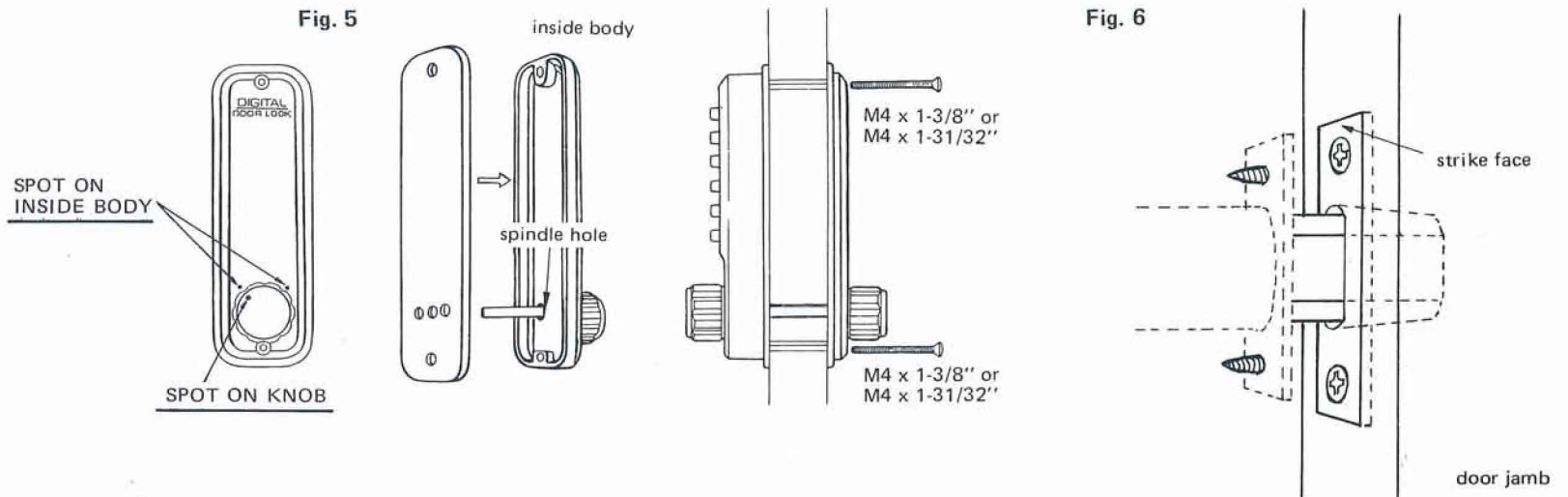

- h. Close the door and decide the position where the deadbolt touches to the face of the door jamb. Make the hole for the Mortised Strike and chisel out the space for strike face until it is flush with the surface. And fasten the strike with the wood screws of M4 x 5/8". (part No. 9) (Refer Fig. 6)

IV. HOW TO USE THE DIGITAL DOOR LOCK

- a. Locked and unlocked by turning the inside knob.
 b. Locked by turning the outside knob.
 c. Unlocked by turning the outside knob after pushing the equipped SECRET NUMBER.

ATTENTION : Operating Instructions

- a. Always press the button 'C' before pushing the SECRET NUMBER for entry.
 b. Press the button 'C' after locking on exit.

(The SECRET NUMBER is printed in the Secret Number Card which is put in this package.)

(In case of changing the SECRET NUMBER; refer the enclosed "How To Change the SECRET NUMBER".)