

ZONE		REV	DESCRIPTION	DATE	APPROVED
-	NC		INITIAL RELEASE		

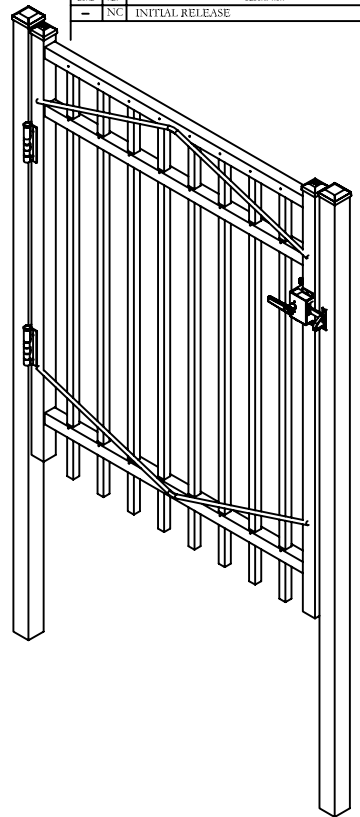

Jerith[®]
 Manufacturing Co., Inc.
 Philadelphia, PA 19154
 (800)344-2242

DRAWING:
INDUSTRIAL GATE
STYLE #202
60" HIGH X 48" WIDE

SIZE D	DWG NO. IN60U20248	REV NC
SCALE	DATE 8-6-08	SHEET 1 OF 1

© 2004. This drawing may not be altered or reproduced without the permission of Jerith Manufacturing Co., Inc.