

DOUBLE "V" RAIL GATE PLAN

Single Gate Configuration - Tapered Top Rail

(8 FOOT WIDE 48" HIGH GATES) **CENTRAL EYE HINGES** (Product Codes #8312) **GATE HUNG BETWEEN POSTS**

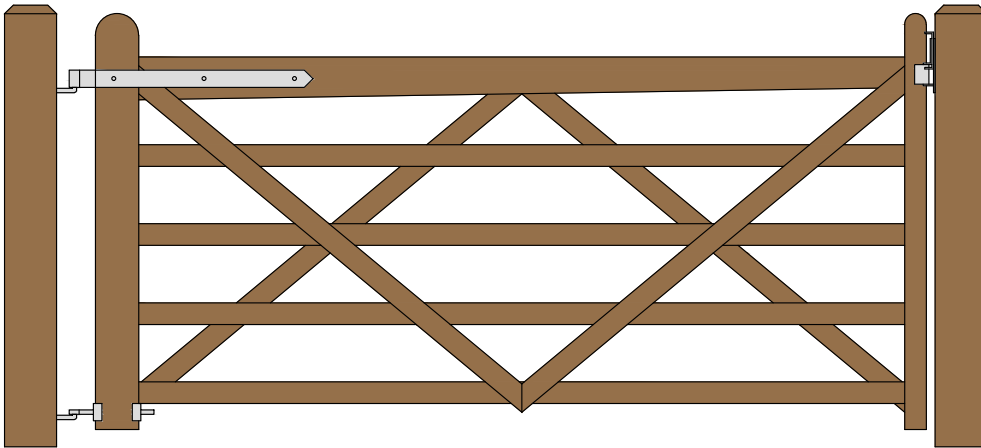

Distance between latch post and gate	A
Width of Gate	B
Distance between gate and hinge post	C
Total distance between posts	D

Hardware Required			
	Galvanized Finish	Black Powder Coat over Galvanized Finish	Central Eye Hinge Advantages
Hinge Set	8312-S242	8312-S24P	
All fasteners are included with the hardware sets	Set Includes		
	one 24 inch double strap (8312-542 or 8312-54SP) one adjustable bottom gate fitting (8250-002 or 8250-00P) two 12" adjustable gate pin (8800-122 or 8800-12P)		
	Central Latch Options		Dimensions (feet and inches)
			A B C D
Quick Catch (shown above)	4100-3SS	4100-3BSS	1.5" 8' 4.5" 8'-6"
Spring Latch	8327-002	8327-00P	4" 8' 4.5" 8'-8.5"
Slide Bolt Latch (Flush/ Jamb Mount)	5002-L122	5002-L12SP	1" 8' 4.5" 8'-5.5"
***Irish Gate Latch	8328-002	8328-00SP	1" 8' 4.5" 8'-5.5"
Lumber Required			
Posts	2 of 8' x 6" x6" (usually dressed out at 5.5" x 5.5")		
	Rails, Stiles (uprights) and Diagonal Braces made from full 1" thick by 5.5" wide lumber (commonly stocked decking material or rough cut lumber) we then cut down what we needed to the 2.5" width dimension for most of the gate and in the process removed any prefinished, rounded corners		
Top Rail (tapered)	3 of 8' x 1" x 5.5"		
Rails	2 of 8' x 1" x 5.5" (cut to 2.5" x 8')		
Stiles	3 of 4' x 1" x 5.5" (2 x 5" wide for the hinge side and 2 x 2.5" wide for the latch side)		
Diagonals	1 of 10' x 1" x 5.5" (cut to 2.5" x 5')		
Filler Pieces	use off cuts from other pieces for all filler pieces		
Fasteners Required			
	FP-DoubleV - Fastener pack for Double V Gate Build (Includes 14 of 3.5" and 15 of 2.5" carriage bolts with nuts and washers & 40 of 1.75" wood screws)		
	Optional Hold Back - Use a 12" Cabin Hook (4270-122 or 4270-12SP) if you require a means of keeping the gate open		
	*** - In order to use the Irish Gate Latch on this gate with its 2.5" stile you will need to cut 2" off the latch bolt - a great option but extra work for the gate builder		

SNUG COTTAGE HARDWARE

Download includes this materials list, component cutting and layout sheet, tips on installing gate posts, and detailed instructions.
For a complete listing of our free gate plans and gate layouts visit hooverfence.com.

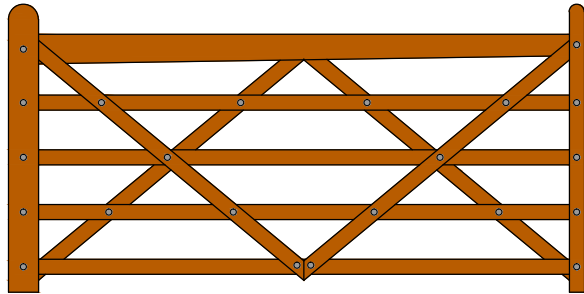

8' DOUBLE 'V' GATE

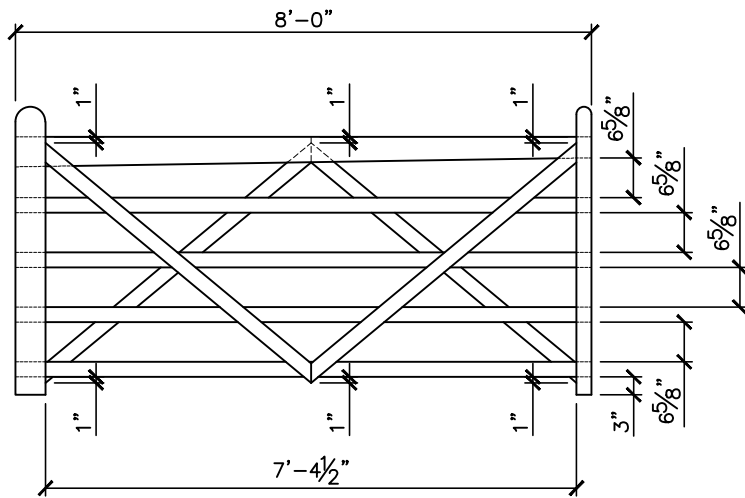

GATE DIMENSIONS

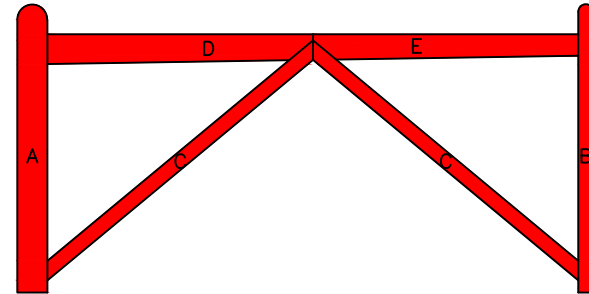

FIRST LAYER

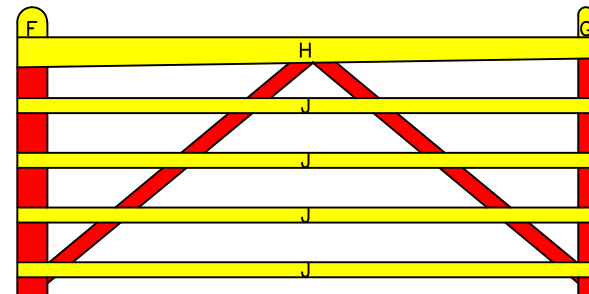

SECOND LAYER

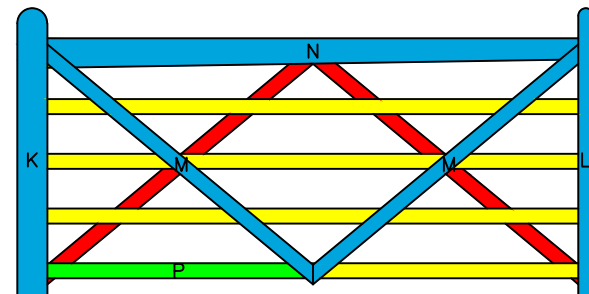

THIRD LAYER

BUILDING STEPS

PROPERTY OF:
 SNUG COTTAGE
 HARDWARE LLC
 MARYSVILLE MI.
 48040

PRODUCT DESCRIPTION:
 8' DOUBLE 'V' GATE
 ALL DIMENSIONS ±0.125"

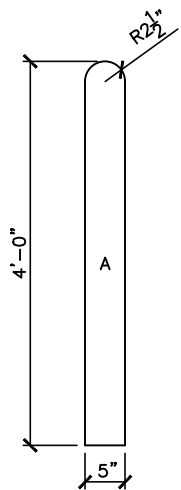

1-1" BOARD

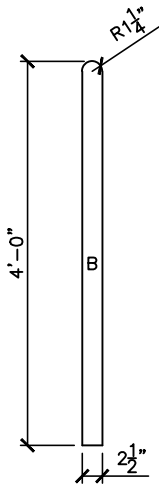

1-1" BOARD

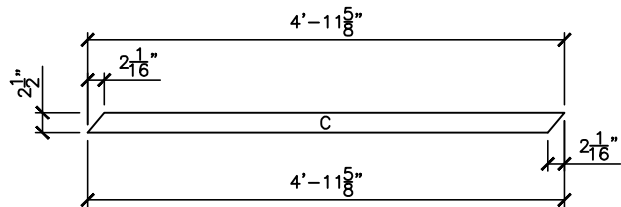

1-1" BOARD

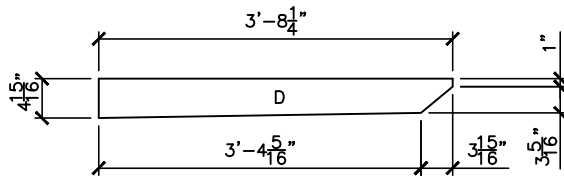

1-1" BOARD

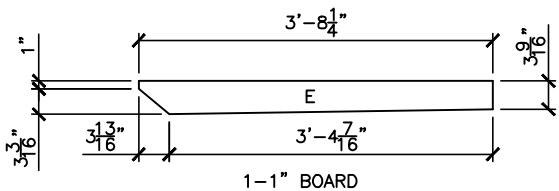

1-1" BOARD

FIRST LAYER COMPONENTS

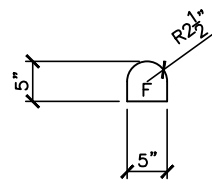

1-1" BOARD

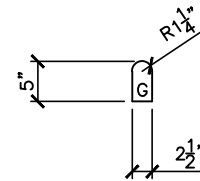

1-1" BOARD

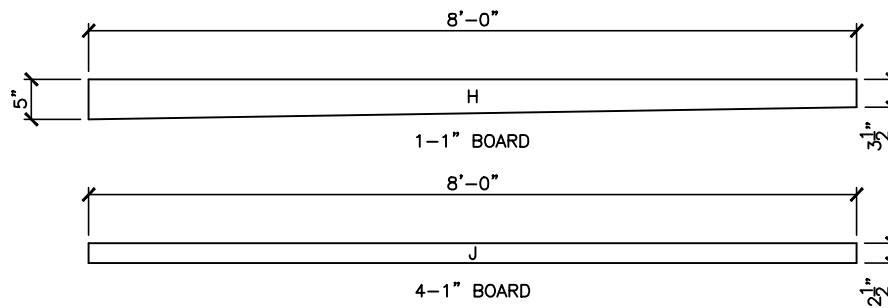

SECOND LAYER COMPONENTS

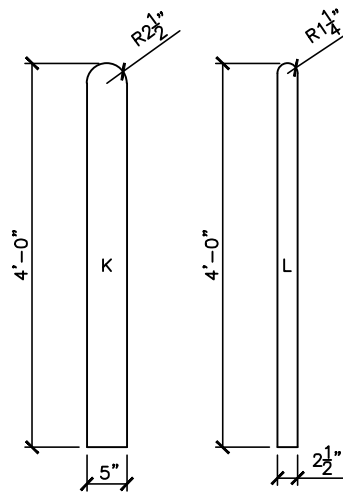

1-1" BOARD

1-1" BOARD

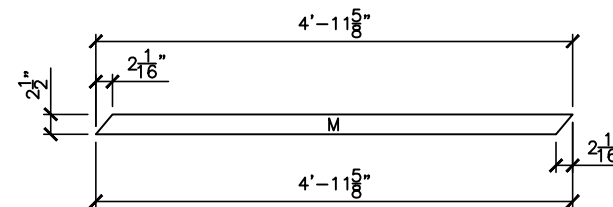

1-1" BOARD

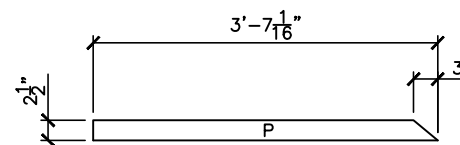

1-1" BOARD (OPTIONAL)

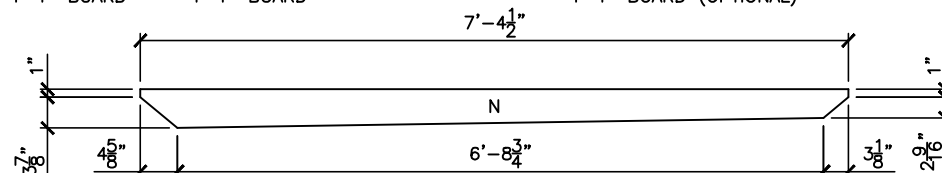

1-1" BOARD

THIRD LAYER COMPONENTS

PROPERTY OF:

SNUG COTTAGE
HARDWARE LLC
MARYSVILLE MI.
48040

PRODUCT DESCRIPTION:

8' DOUBLE 'V' GATE COMPONENTS

ALL DIMENSIONS ±0.125"