

Installation Manual



4000XLS



4200XLS

DUAL Gate Operator System

In a DUAL gate system the 4000XLS is the MASTER gate operator and the 4200XLS is the SECOND gate operator.

PROFESSIONAL INSTALLATION RECOMMENDED!

WARNING!

This equipment is similar to other gate or door equipment and meets or exceeds Underwriters Laboratory Standard 325 (UL 325). However, gate equipment has hazards associated with its use and therefore by installing this product the installer and user accept full responsibility for following and noting the installation and safety instructions. Failure to follow installation and safety instructions can result in hazards developing due to improper assembly. You agree to properly install this product and that if you fail to do so Gates That Open, LLC, ("GTO") shall in no event be liable for direct, indirect, incidental, special or consequential damages or loss of profits whether based in contract tort or any other legal theory during the course of the warranty or at any time thereafter. The installer and/or user agree to assume responsibility for all liability and use of this product releasing Gates That Open, LLC, from any and all liability. If you are not in agreement with this disclaimer or do not feel capable of properly following all installation and safety instructions you may return this product for full replacement value.

READ ALL INSTRUCTIONS CAREFULLY AND COMPLETELY before attempting to install and use this automatic gate operator. This gate operator produces a high level of force. Stay clear of the unit while it is operating and exercise caution at all times.

All automatic gate operators are intended for use on *vehicular gates only*.



This product meets and exceeds the requirements of UL 325, the standard which regulates gate operator safety, as established and made effective March 1, 2000, by Underwriters Laboratories Inc.



For more information on the GTO/ACCESS SYSTEMS full line of automatic gate operators and access controls visit our website at www.gtoaccess.com.

Class Rating

The GTO 4000XLS/4200XLS Gate Operator is intended for use with **vehicular swing gates in single family residential applications**. The operator is system certified to be in compliance with UL 325, current edition, as of publication date.

Vehicular Gate Operator Class Categories:

Residential Vehicular Gate Operator—Class I: A vehicular gate operator (or system) intended for use in a home of one-to-four single family dwelling, or a garage or parking area associated therewith.

Commercial/General Access Vehicular Gate Operator—Class II: A vehicular gate operator (or system) intended for use in a commercial location or building such as a multifamily housing unit (five or more single family units), hotel, garages, retail store, or other building servicing the general public.

Industrial/Limited Access Vehicular Gate Operator—Class III: A vehicular gate operator (or system) intended for use in an industrial location or building such as a factory or loading dock area or other locations not intended to service the general public.

Restricted Access Vehicular Gate Operator—Class IV: A vehicular gate operator (or system) intended for use in a guarded industrial location or building such as an airport security area or other restricted access locations not servicing the general public, in which unauthorized access is prevented via supervision by security personnel.

Converting Metric Units to English Equivalents

When You Know	Multiply By	To Find	Symbol
centimeters	0.3937	inches	in. (or ")
meters	3.2808	feet	ft. (or')
kilograms	2.2046	pounds	lb. (or #)

Converting English Units to Metric Equivalents

When You Know	Multiply By	To Find	Symbol
inches	2.5400	centimeters	cm
feet	0.3048	meters	m
pounds	0.4535	kilograms	kg

Converting Temperature

deg. Celsius	$(^{\circ}\text{C} \times 1.8) + 32$	deg. Fahrenheit	$^{\circ}\text{F}$
deg. Fahrenheit	$(^{\circ}\text{F} - 32) \div 1.8$	deg. Celsius	$^{\circ}\text{C}$

FOR YOUR RECORDS

Please record the following information product serial number (located on right side of control box), be sure to **keep all receipts for proof of purchase**. Refer to this information when calling GTO for service or assistance with your automatic gate opener.

Serial Number: _____ Date of Purchase: _____

Place of Purchase: _____

Table of Contents

Class Rating	inside cover
Please Read This First	ii
Important Safety Instructions.....	iii
Technical Specifications.....	1
Before You Begin	2
Determine Charging Option for Battery: Transformer OR Solar	2
Solar Panel and Gate Activity Chart	2
Check Direction of Gate Swing	3
Prepare the Gates.....	3
Gate Grounding	3
4000XLS Parts List.....	4
4200XLS Parts List.....	5
Tools Needed	6
Materials You may Need for the Installation:	6
Installation Overview	7
Install the Master Gate Operator	7
Install the Post Bracket Assembly	8
Check Clearance	9
Install Gate Bracket.....	10
Attach Operator.....	10
Install the Second Gate Operator	11
Install the Closed Position Stops	11
Mount the Control Box and Receiver.....	13
Connect Operator Power Cables	14
Connect the Power Input.....	16
Connect Battery.....	18
Control Board Settings	18
Set the Closed Position Limit (for Pull-To-Open Applications)	19
Adjust the Stall Force Setting	20
Set Auto Close Time	20
Program Your Personal Transmitter Setting	21
DIP Switch Settings	22
Connecting Accessories.....	23
Wiring Accessories.....	24
Connecting Other Auxiliary Devices (Sirens, Lights, etc.).....	24
Push-To-Open Installation Information.....	25
Setting the Open Position Limit (Push-To-Open Installations).....	26
Column Installation	27
Troubleshooting Guide.....	28
Voltage Readings	29
Repair Service.....	30
Accessories	31

Please Read This First



Thank you for purchasing a GTO/ACCESS SYSTEMS 4000XLS/4200XLS. When correctly installed and properly used, your 4000XLS/4200XLS operators will give you many years of reliable service. Please read the following information to ensure you have the correct system for your particular needs. This manual will enable you to properly install your 4000XLS/4200XLS Automatic Gate Operators.

The 4000XLS/4200XLS operators are designed for installation on pull-to-open dual leaf gates. The gates must not exceed 20 feet in length nor weigh more than 1000 pounds* per leaf (please see Technical Specifications on page 1). The 4000XLS/4200XLS operators can be used on vinyl, aluminum, chain link, farm tube, and wrought iron gates. **Use on solid (wood) gates is not recommended. Solid surface gates have a high resistance to the wind. If the wind is strong enough, the operators will obstruct, stop, and blow fuses.**

The 4000XLS/4200XLS can be installed on push-to-open gates with the addition of two (2) push-to-open brackets  [R4KPTO].

The 4000XLS/4200XLS operators accommodates extra transmitters, digital keypads, solar panels, push buttons, automatic gate locks, and other access control products. **These optional accessories are noted with the  symbol.**

The 4000XLS/4200XLS operators feature **adjustable stall force**. This safety feature makes the gates stop and reverse direction within two seconds when it comes in contact with an obstruction. The "MIN" setting means the gate will exert the minimum force on an obstruction before it stops and reverses direction.

The 4000XLS/4200XLS operators also have an **adjustable auto-close** feature. After the gates reach the fully open position, they can be set to remain open from 3 to 120 seconds before automatically closing. Pressing the transmitter button at any time after the gates fully open will cause them to close immediately. "OFF" is the factory setting; meaning the gates will stay open until you press the transmitter button (or keypad, etc.) again.

Please call GTO at (800) 543-GATE [4283] or (850) 575-0176 for more information about our GTO/ACCESS SYSTEMS professional line of gate operators and accessories. Our Sales Department will be glad to give you the name and phone number of a GTO/ACCESS SYSTEMS dealer near you.

BEFORE YOU BEGIN TO INSTALL YOUR AUTOMATIC GATE OPERATORS:

Read these instructions carefully and completely to become familiar with all parts and installation steps. You must read the installation manual for detailed instructions on gate operators safety and proper use of the gate operators.



24/7 Troubleshooting Wizard: <http://support.gtoinc.com>



GTO Accessories are noted with this symbol in this Installation Manual. Information about accessories can be found on page 31 and at www.gtoaccess.com.

IMPORTANT SAFETY INSTRUCTIONS



Because automatic gate operators produce high levels of force, consumers need to know the potential hazards associated with improperly designed, installed, and maintained automated gate operator systems. *Keep in mind that the gate operator is just one component of the total gate operating system.* Each component must work in unison to provide the consumer with convenience, security, and safety.

This manual contains various safety precautions and warnings for the consumer. Because there are many possible applications of the gate operator, the safety precautions and warnings contained in this manual cannot be completely exhaustive in nature. They do, however, provide an overview of the safe design, installation, and use of this product. **CAREFULLY READ AND FOLLOW ALL SAFETY PRECAUTIONS, WARNINGS, AND INSTALLATION INSTRUCTIONS TO ENSURE THE SAFE SYSTEM DESIGN, INSTALLATION, AND USE OF THIS PRODUCT.**

Precautions and warnings in this manual are identified with this  warning symbol. The symbol identifies conditions that can result in damage to the operator or its components, serious injury, or death.

Because GTO automatic gate operators are only part of the total gate operating system, it is the responsibility of the installer/consumer to ensure that the total system is safe for its intended use.

How To Manually Open and Close the Gate:

 **CAUTION:** The gate can be opened and closed manually when the operator is disconnected. **ONLY** disconnect the operator when the power switch is OFF and the gate is NOT moving.

Disconnecting the Operator

1. Turn operator power switch (Control Box) OFF.
2. Remove hairpin clip, clevis pin, and bushing from both the front and rear mounting points.
3. Remove the operator from the mount.

 **CAUTION:** Because the GTO gate operator is battery powered, disconnect the operator **ONLY** when the power switch on the control box is turned OFF. Unplugging the transformer does not turn power to the operator OFF.

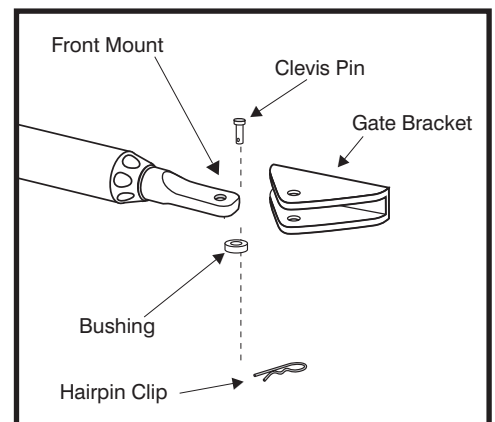

NOTE: Substitute a Pin Lock  [FM345] for the clevis pin on the front mount of the gate operator to prevent unauthorized removal of the operator from the gate.

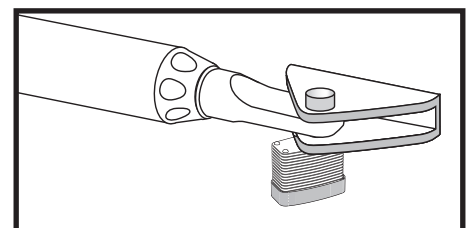



IMPORTANT SAFETY INSTRUCTIONS

For The Consumer

WARNING: To reduce the risk of injury or death:

1. **READ AND FOLLOW ALL INSTRUCTIONS.** Failure to meet the requirements set forth in the instruction manual could cause severe injury or death, for which the manufacturer cannot be held responsible.
2. When designing a system that will be entered from a highway or main thoroughfare, make sure the system is placed far enough from the road to prevent traffic congestion.
3. The gate must be installed in a location that provides adequate clearance between it and adjacent structures when opening and closing to reduce the risk of entrapment. Swinging gates must not open into public access areas.
4. The gate and gate operator installation **must comply with any applicable local codes.**

I. Before Installation

1. Verify this operator is proper for the type and size of gate, its frequency of use, and the proper class rating.
2. Make sure the gate has been properly installed and swings freely in both directions. Repair or replace all worn or damaged gate hardware prior to installation. A freely moving gate will require less force to operate and will enhance the performance of the operator and safety devices used with the system.
3. Review the operation of the system to become familiar with its safety features. Understand how to disconnect the operator for manual gate operation (page iii).
4. This gate operator is intended for vehicular gates **ONLY**. A separate entrance or gate must be installed for pedestrian use (page vi).
5. Always keep people and objects away from the gate and its area of travel. **NO ONE SHOULD CROSS THE PATH OF A MOVING GATE.**
6. Pay close attention to the diagram below and be aware of these areas at all times.

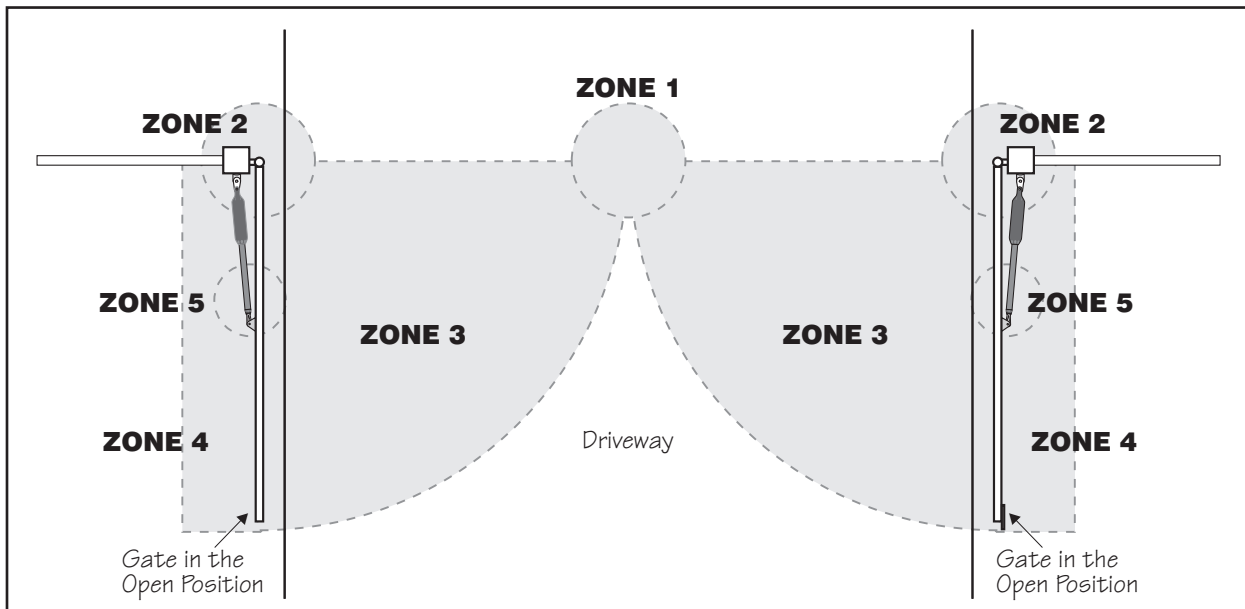

Entrapment Zones for a proper Pull-To-Open installation:

- Zone 1** – leading edge of the gate.
- Zone 2** – between the gate and the gate post.
- Zone 3** – the path of the gate.
- Zone 4** – the space between the gate in the open position and any object such as a wall, fence, etc.
- Zone 5** – pinch points between the operator and gate.

IMPORTANT SAFETY INSTRUCTIONS



II. During Installation

1. Install the gate operator on the inside of the property and fence line. **DO NOT** install an operator on the outside of the gate where the public has access to it.
2. Be careful with moving parts and avoid close proximity to areas where fingers or hands could be pinched.
3. **Devices such as contact sensors (safety edges) and non contact sensors (photo beams) provide additional protection against entrapment.**
4. If push buttons or keypads are installed, they should be within sight of the gate, yet located at least 10 feet from any moving part of the gate (see diagram below). **Never install any control device where a user will be tempted to reach through the gate to activate the gate operator.**
5. Do not activate your gate operator unless you can see it and can determine that its area of travel is clear of people, pets, or other obstructions. Watch the gate through its entire movement.
6. Secure outdoor or easily accessed gate operator controls in order to prohibit unauthorized use of the gate.

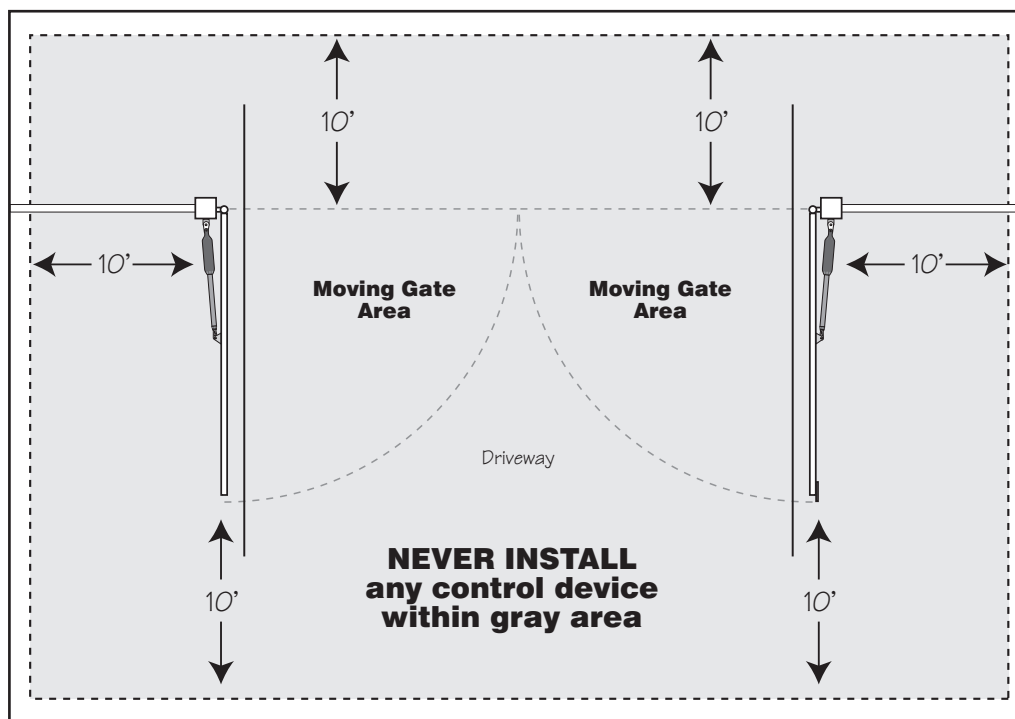

III. After Installation

1. Attach the **warning signs (included)** to each side of the gate to alert the public of automatic gate operation. It is **your responsibility** to post warning signs on both sides of your gate. If any of these signs or warning decals become damaged, illegible or missing, replace them immediately. Contact GTO for free replacements.
2. The gate is automatic and could move at any time, posing a serious risk of entrapment. No one should be in contact with an activated gate when it is moving or stationary.
3. Do not attempt to drive into the gate area while the gate is moving; wait until the gate comes to a complete stop.
4. Do not attempt to "beat the gate" (drive through) while the gate is closing. This is extremely dangerous.
5. Do not allow children or pets near your gate. **Never let children operate or play with gate controls.** Keep ALL gate controls away from children and unauthorized users; store controls where children and unauthorized users do not have access to them.
6. **KEEP GATE AND GATE Operator PROPERLY MAINTAINED.** Always turn power to operator OFF before performing any maintenance. Regularly grease the gate hinges. Apply silicone spray to a soft, dry cloth and clean the push-pull tube at least once a month.



IMPORTANT SAFETY INSTRUCTIONS

7. To operate this equipment safely, YOU must know how to disconnect the operator for manual gate operation (page iii). If you have read the instructions and still do not understand how to disconnect the operator, contact the GTO Service Department.
8. Disconnect the operator **ONLY** when the power is **TURNED OFF** and the gate is **NOT** moving.
9. Make arrangements with local fire and law enforcement for emergency access.
10. Distribute and discuss copies of the **IMPORTANT SAFETY INSTRUCTIONS** section of this manual with all persons authorized to use your gate.
11. **IMPORTANT: Save these safety instructions. Make sure everyone who is using or will be around the gate and gate operator are aware of the dangers associated with automated gates. In the event you sell the property with the gate operator or sell the gate operator, provide a copy of these safety instructions to the new owner.**

Should you lose or misplace this manual, a copy can be obtained by downloading one from the GTO web site (www.gtoaccess.com), by contacting Gates That Open, LLC., at 3121 Hartsfield Road, Tallahassee, Florida 32303 or by calling 1-800-543-4283 and requesting a duplicate copy. One will be provided to you free of charge.

Required Safety Precautions for Gates

Install Warning Signs

Warning signs alert people of automatic gate operation and are **required** when installing the GTO Gate Operator. The Warning Signs included must be installed on both sides of each gate. Furthermore, a walk-through gate must be installed for pedestrian traffic. We recommend using the **GTO Bulldog Pedestrian Gate Lock**  [FM145] for controlled access.

Entrapment Protection

GTO's inherent obstruction settings, even when properly adjusted, **may not be sensitive enough to prevent bodily injury in some circumstances**. For this reason, safety devices such as safety edge sensors (or photoelectric sensors), which stop and reverse gate direction upon sensing an obstruction, are suggested for enhanced protection against entrapment.

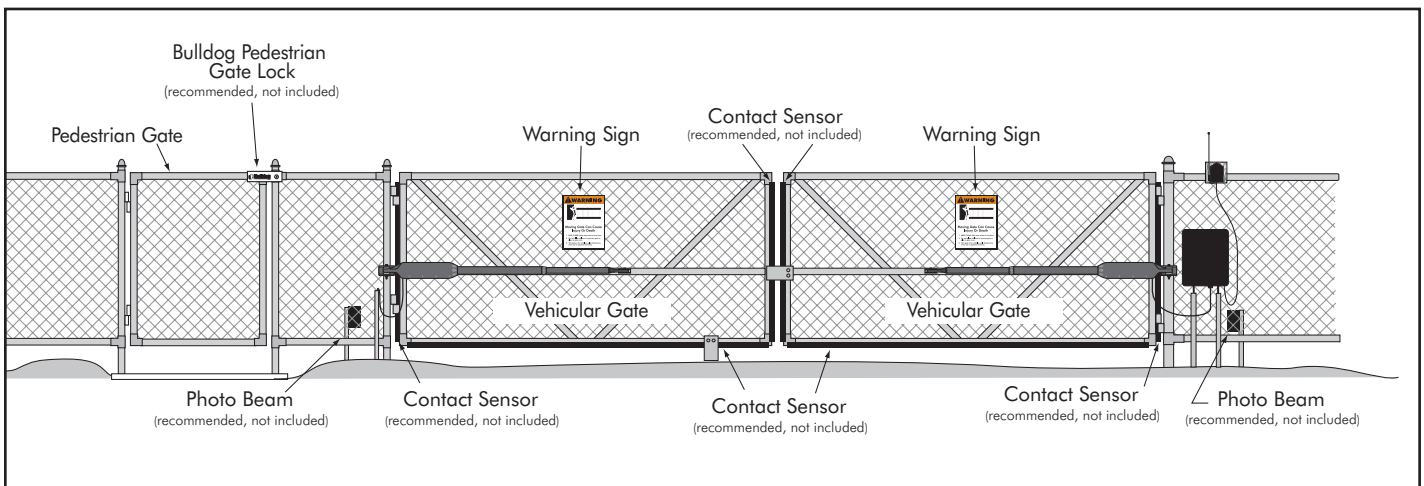

IMPORTANT SAFETY INSTRUCTIONS



Secondary Means of Protection Against Entrapment

As specified by Gate Operator Safety Standard, UL 325 (30A.1.1), automatic gate operators shall have an inherent entrapment sensing system, and shall have *provisions for, or be supplied with*, at least one independent secondary means to protect against entrapment. The 4000XLS/4200XLS utilizes **Type A**, an inherent (i.e., built-in) entrapment sensing system as the **primary** type of entrapment protection. Also, the 4000XLS/4200XLS has *provisions for* the connection of **Type B1 or B2** protection to be used as the **secondary** type of entrapment protection, if desired.

1. For gate operators utilizing a non-contact sensor (e.g., photo-electric sensor– Type B1) in accordance with UL 325 (51.8.4 [h]):
 - A. Refer to the sensor manufacturer's instructions on the placement of non-contact sensors for each type of application.
 - B. Care shall be exercised to reduce the risk of nuisance tripping, such as when a vehicle trips the sensor while the gate is still moving.
 - C. One or more non-contact sensors shall be located where the risk of entrapment or obstruction exists, such as the perimeter reachable by a moving gate or barrier.
2. For gate operators utilizing a contact sensor (e.g., safety edge sensor– Type B2) in accordance with UL 325 (51.8.4 [i]):
 - A. One or more contact sensors shall be located at the leading edge, bottom edge, and post edge, both inside and outside of a vehicular swing gate system.
 - B. A hard wired contact sensor shall be located and its wiring arranged so that the communication between the sensor and the gate operator is not subjected to mechanical damage.
 - C. A wireless contact sensor such as one that transmits radio frequency (RF) signals to the gate operator for entrapment protection functions shall be located where the transmission of the signals are not obstructed or impeded by building structures, natural landscaping or similar obstruction. A wireless contact sensor shall function under the intended end-use conditions.

You may want to consider adding photo beams to your installation. GTO Photo Beams [R4222] provide a “non contact” means of entrapment protection.

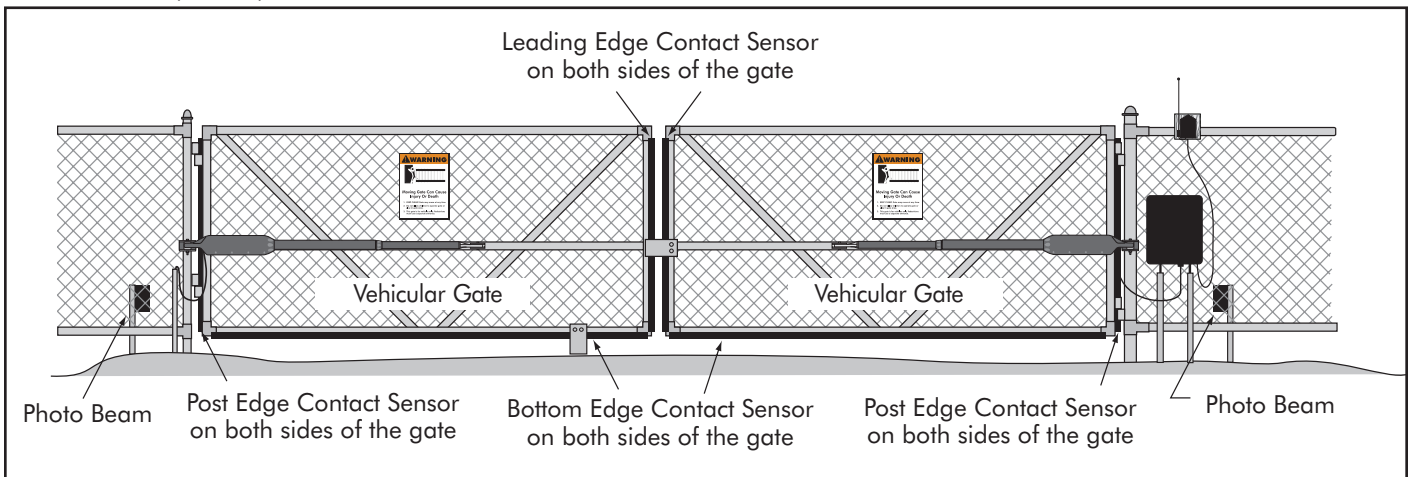

ENTRAPMENT ALARM (UL 325; 30A.1.1A)

The 4000XLS/4200XLS Gate Operators are designed to stop and reverse within 2 seconds when a gate comes in contact with an obstruction. Additionally, these operators are equipped with an **audio entrapment alarm** which will activate if the unit obstructs **twice** while opening or closing. This alarm will sound for a period of 5 minutes, or until the operator receives an intended signal from a hard wired entry/exit source (e.g. push button control or keypad) and the gate returns to a fully open or fully closed position. Turning the power switch on the control box OFF and back ON will also deactivate the alarm. Wireless controls such as transmitters and wireless keypads will not deactivate the alarm.



IMPORTANT SAFETY INSTRUCTIONS

WARNING

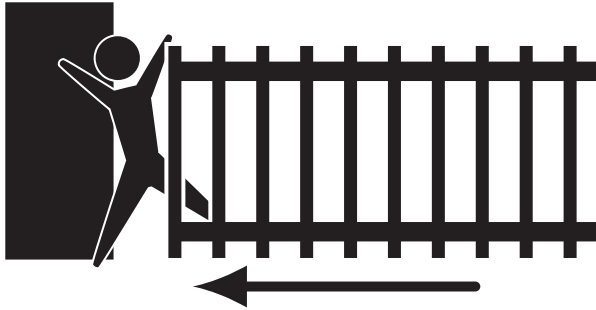

Moving Gate Can Cause Injury Or Death

1. **KEEP CLEAR!** Gate may move at any time.
2. **Do not allow children to operate gate or play in gate area.**
3. **This gate is for vehicles only. Pedestrians must use a separate entrance.**



GTO DC SWING SERIES

Conforms to **UL 325 STANDARDS**

Maximum Gate: 1000 lb. (453.5 kg); 20 ft. (6.1 m)

Voltage: 12 Vdc; Frequency: 0 Hz; Power: 60 W

Class I Vehicular Swing Gate Operator.

Serial Number: XXXXXX

9901178

TO MANUALLY OPEN AND CLOSE THE GATE:

1. Turn control box power switch OFF.
2. Disconnect front or rear mount.
3. Pull operator away from front or rear mounts.

Disconnect operator ONLY when the control box power switch is OFF and the gate is NOT moving.

XXXXXX

Gates That Open, LLC • Tallahassee, Florida USA

Warning signs (4 enclosed) to be installed on each side of the gate (3–5 feet above the bottom of the gate).

Product identification and manual operation instruction label (1) installed on control box.

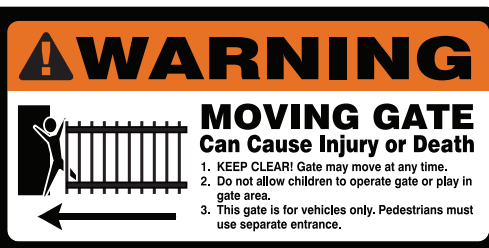

Logo and warning labels (2) installed on each side of master operator housing.



Logo and warning labels (2) installed on each side of second operator housing.

Technical Specifications

GTO/ACCESS SYSTEMS 4000XLS/4200XLS AUTOMATIC GATE OPERATOR

DRIVE

- Low friction screw drive (linear actuator) rated for -5 °F to +160 °F (-21 °C to +71 °C). Use of GTO battery heater FM316 (Not solar compatible) is recommended in extreme cold temperatures.)
- Powered by a 12 V motor with integral case hardened steel gear reducer. Motor speed reduced to 375 rpm.
- Maximum opening arc of 110°. Approximate opening time (90°): 16-20 seconds.

POWER

- The system is powered by a 12 Vdc, 7.0 Ah, sealed, rechargeable acid battery.
- Battery charge is maintained by a 120 Vac, 18 Vac output transformer. Blade-style control board fuse is rated for 25 A.
NOTE: The transformer should not be directly connected to any battery. Do not replace fuses with higher ampere rated fuses; doing so will void your warranty and may damage your control board.
- For optional solar charging see page 2.

CONTROL

- GTO microprocessor-based control board is set for pull-to-open gate installations. DIP switches can be adjusted to accommodate an optional kit for push-to-open gates (see Accessory Catalog).
- A circuit on the control board regulates charging. "Sleep draw" is 25 mA; "active draw" is 5 to 9 A.
- Auto-memorization of digital transmitter code.
- GTO remote-mounted RF receiver tuned to 318 MHz.
- Operator length with push-pull tube fully retracted is 46 1/4", mounting point to mounting point, arm stroke 22" max.
- Minimum gate length is 6 ft.
- Adjustable auto-close (3 to 120 seconds), and stall force potentiometers.
- Power terminal block accommodates a transformer or solar panels (not both).
- DIP switches simplify setup of gate operator.
- Accessory terminal block fully compatible with GTO push button controls, digital keypads, loops detectors, etc.
- Control board allows connection of safety edge sensors and photoelectric sensors.
- Audio entrapment alarm sounds if unit encounters an obstruction twice while opening or closing.

OPERATIONAL CAPACITY

- The Gate Capacity Chart shows approximate cycles, per day, you can expect from the 4000XLS/4200XLS Automatic Gate Operators when powered with a transformer. Actual cycles may vary slightly depending upon the type and condition of gate and installation.

NOTE: BALL BEARING HINGES SHOULD BE USED ON ALL GATES WEIGHING OVER 250 LB.

GTO/ACCESS SYSTEMS 4000XLS/4200XLS Gate Capacity Chart									
<i>Estimated number of daily cycles, based on use with a transformer and one(1) 12 Volt battery</i>									
Gate Length	20 ft.	135	130	125	120	115	110	105	100
	16 ft.	140	135	130	125	120	115	110	105
	12 ft.	145	140	135	130	125	120	115	110
	6 – 10 ft.	150	145	140	135	130	125	120	115
	300 lb.	400 lb.	500 lb.	600 lb.	700 lb.	800 lb.	900 lb.	1000 lb.	
Gate Weight									

To determine the number of cycles the gate operator will perform using solar panels, please see the specifications listed on page 2.

* An operation cycle is one full opening and closing of the gate.

These specifications are subject to change without notice.

Before You Begin...

1. Determine Charging Option for Battery: Transformer OR Solar

**NEVER USE TRANSFORMER AND SOLAR PANEL(S) AT THE SAME TIME.
It will damage the control board.**

IMPORTANT:

- The 4000XLS/4200XLS' 12 volt battery must be charged by either connecting the transformer (included) or solar panel kit ⊕ [FM123] to the control board.
- The transformer is designed for indoor use. If the transformer can be plugged only into an outside electrical outlet, a weatherproof cover/housing (available at local electrical supply stores) must be used.
- If your gate is more than 1000 ft. from an AC power source, you will need to use at least 10 watts solar charging power to charge the battery ⊕ [FM123]. Refer to the Solar Panel and Gate Activity chart below.
- All low voltage wire used with the GTO Gate Operator must be 16 gauge dual conductor, stranded, direct burial wire ⊕ [RB509]. Do not run more than 1000 ft. of wire.

Solar Panel and Gate Activity Chart

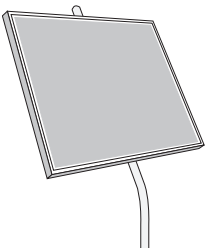

The table and map illustrate the maximum number of gate cycles to expect per day in a particular area when using from 10 to 30 watts of solar charging power. The figures shown are for winter (minimum sunlight).

Winter Ratings for 12 V Single Gate	Zone 1	Zone 2	Zone 3
10 watts	4	8	13
15 watts	7	13	20
20 watts	10	18	27
25 watts	13	23	34
30 watts	16	28	41

Accessories connected to your system will draw additional power from the battery.

NOTE: A minimum of 10 watts solar charging power is needed to charge the batteries. Adding a second battery ⊕ [RB500] will improve the number of gate cycles.

- ⊕ 10 Watt Solar Panel [FM123]
- ⊕ 5 Watt Solar Panel [FM122]

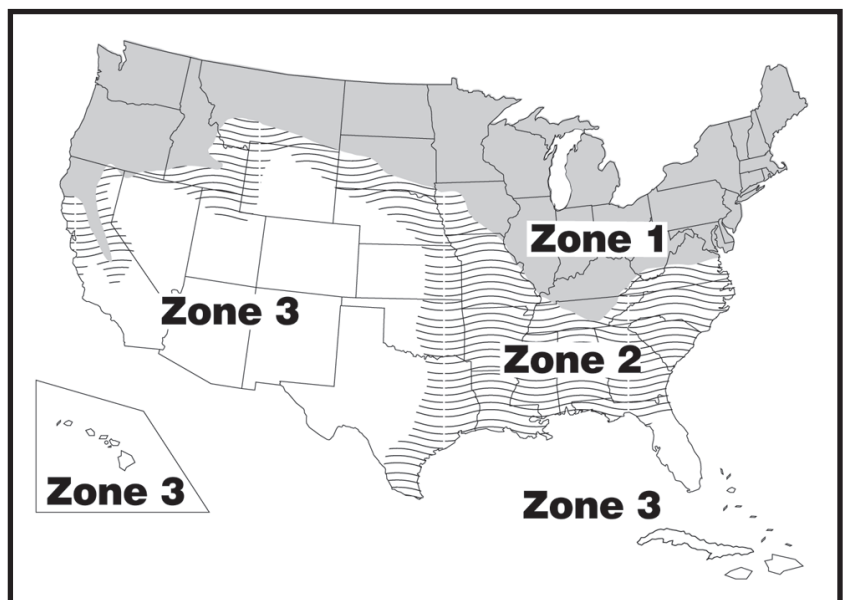

2. Check Direction of Gate Swing

The 4000XLS/4200XLS is designed for Pull-To-Open installations. Push-To-Open installations require a Push-To-Open Bracket [R4KPTO]. Please refer to specific Push-To-Open Installation Information on page 25.

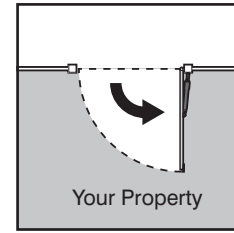

Pull-To-Open
(arm retracts to open)

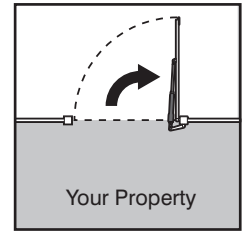

Push-To-Open
(arm extends to open)

3. Prepare the Gates

- The gates must be plumb, level, and swing freely on their hinges.
- The gates must move throughout it's arc without binding or dragging on the ground.
- Wheels must NOT be attached to the gates.
- Gates over 250 lb. should have ball bearing hinges with grease fittings.
- Post must be secured in the ground with concrete (minimizes twist/flex when the operator is activated).
- Make sure there is a stable area for mounting the gate brackets (this may require the addition of a horizontal or vertical cross member).
- We recommend you position the operators near the center-line of the gates to keep the gate from twisting and flexing, and to avoid back-splash from rain.

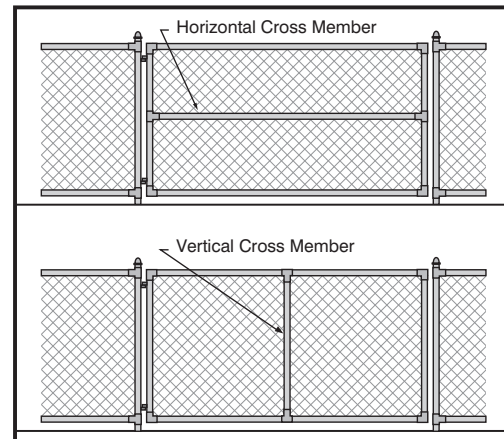
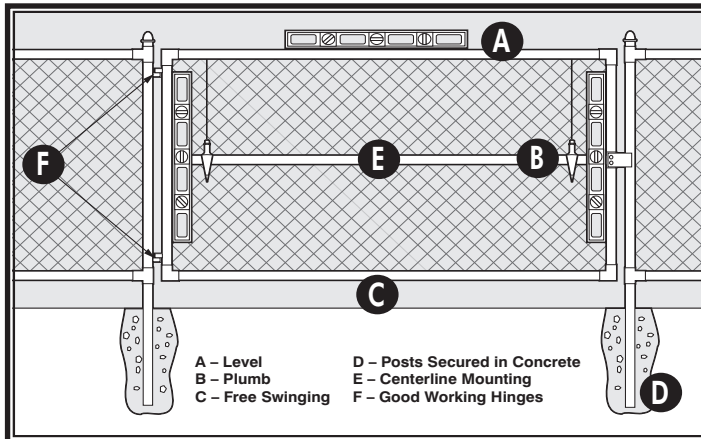

4. Gate Grounding

- Shorter cable is better, 1 to 2 feet recommended.
- Bolt ring terminal at end of cable 4 - 6 inches above ground level.

⊕ R4196 Kit Includes:

- ① Ground Rod Clamp
- ② 6 AWG Wire (3 feet)

NOTE: No grounding system absolutely protects against lightning strikes. If installed correctly, a grounding system will help minimize damage to your gate opener.

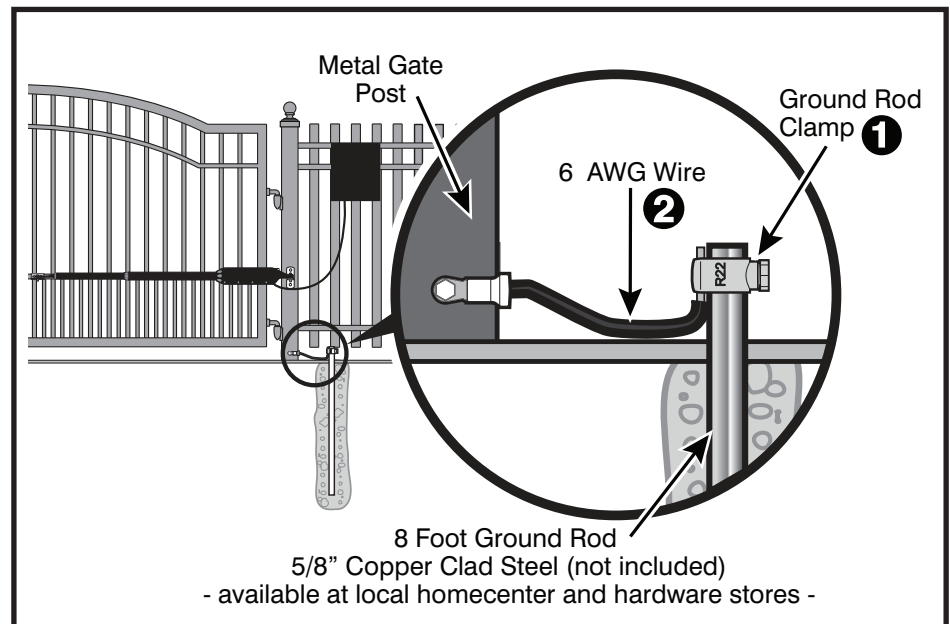

5. 4000XLS Parts List

CONTROL BOX AND ELECTRICAL COMPONENTS

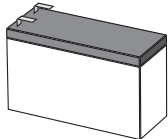

Battery (1)
RB500



GTO Transmitter(1)
RB741

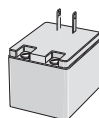

Transformer (1)
RB570

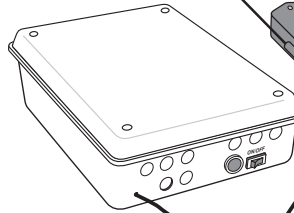

Control Board

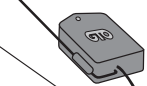

Receiver (1)
AQ201NB

WARNING



Moving Gate Can Cause Injury Or Death

1. KEEP CLEAR! Gate may move at any time.
2. Do not allow children to operate gate or play in gate area.
3. This gate is for vehicles only. Pedestrians must use a separate entrance.

Warning Signs (2)



Customer Support Card

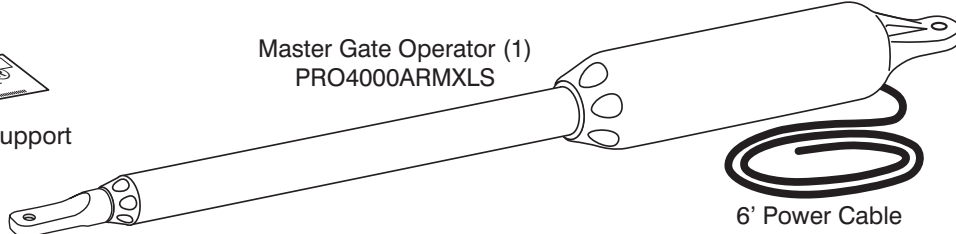

Master Gate Operator (1)
PRO4000ARMXLS



6' Power Cable

BRACKET BOX - HB4000

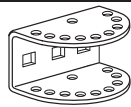

Post Bracket (1)



Gate Bracket (1)

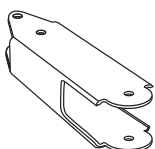

Post Pivot Bracket (1)

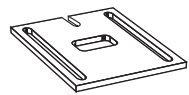

Closed Position Stop Plate (1)

HARDWARE BAG - H401P

8' Nylon Cable Tie (10)

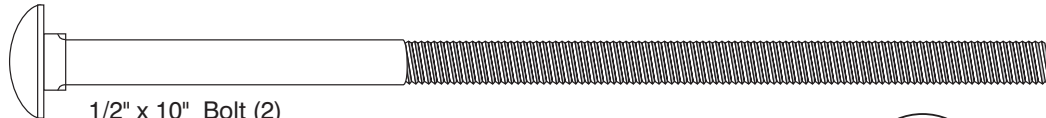

1/2" x 10" Bolt (2)

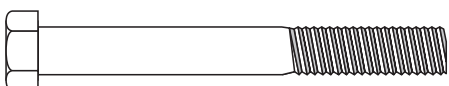

1/2" x 2-3/4" Bolt (2)

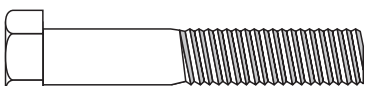

3/8" x 3-3/4" Bolt (2)

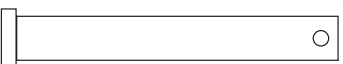

3/8" x 3-1/2" Clevis Pin (1)

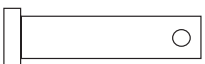

3/8" x 1-3/4" Clevis Pin (1)

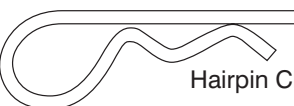

Hairpin Clip (2)

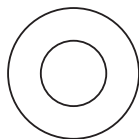

1/2" Washer (4)



1/2" Lock Nut (4)

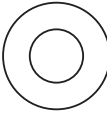

3/8" Washer (3)



3/8" Lock Nut (2)



2" Receiver Mounting Screws (5)

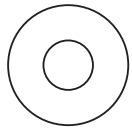

3/8" x 1/2" Bushing (2)

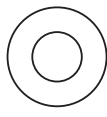

3/8" x 3/16" Bushing (2)

6. 4200XLS Parts List

Second Gate Operator (1)
PRO4200ARMXLS

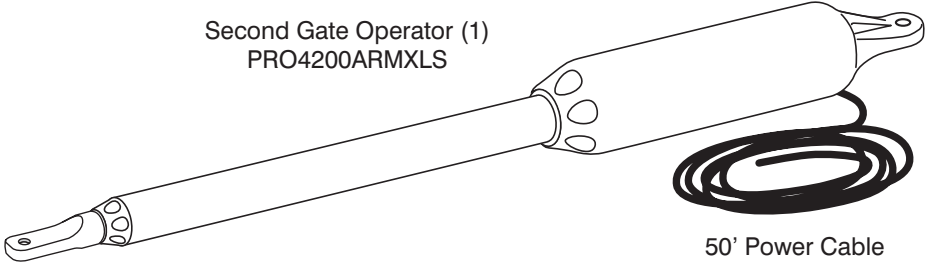

50' Power Cable

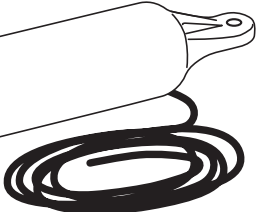

WARNING



Moving Gate Can Cause Injury Or Death

1. KEEP CLEAR! Gate may move at any time.
2. Do not allow children to operate gate or play in gate area.
3. This gate is for vehicles only. Pedestrians must use a separate entrance.

Warning Signs (2)

BRACKET BOX - HB4000

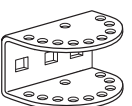

Post Bracket (1)



Gate Bracket (1)

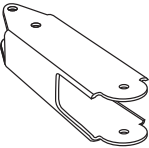

Post Pivot Bracket (1)



Closed Position Stop Plates (1)

HARDWARE BAG - H401P



8' Nylon Cable Tie (10)

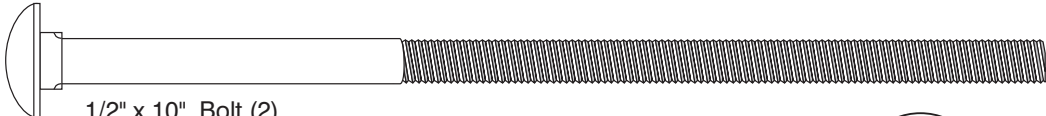

1/2" x 10" Bolt (2)

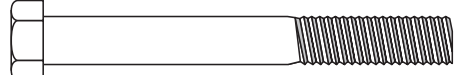

1/2" x 2-3/4" Bolt (2)

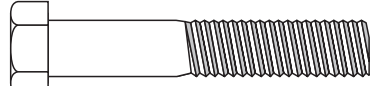

3/8" x 3-3/4" Bolt (2)



3/8" x 3-1/2" Clevis Pin (1)



3/8" x 1-3/4" Clevis Pin (1)

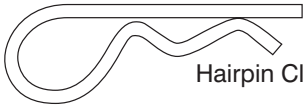

Hairpin Clip (2)

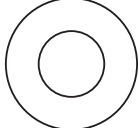

1/2" Washer (4)



1/2" Lock Nut (4)

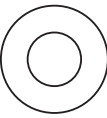

3/8" Washer (3)



3/8" Lock Nut (2)

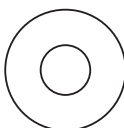

3/8" x 1/2" Bushing (2)

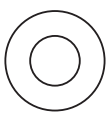

3/8" x 3/16" Bushing (2)



2" Receiver Mounting Screws (5)

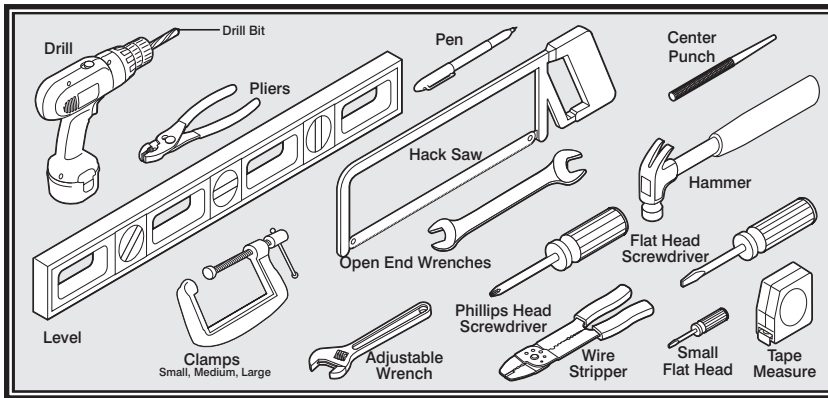

7. Tools Needed

- Power Drill
- Pliers
- Level
- Tape Measure
- Wire Strippers
- Center Punch
- Open End Wrenches: 9/16" and 3/4"
- Drill Bit: 1/2"
- Hacksaw or Heavy Duty Bolt Cutters
- Small (Flat Head) Screwdriver
- Phillips Screwdriver
- C-Clamps: small, medium, and large
- Adjustable Wrench
- Extra person will be helpful

8. Materials You may Need for the Installation:

Depending on the type of gates and posts, you may need some additional materials/hardware.

- Low voltage wire Ⓢ [RB509]. Length depends upon the distance between the transformer power supply and the control box. (Page 16)
- If the gate is more than 1000' away from an AC power source you will need to use at least one 10 watt Solar Panel Ⓢ [FM123] to trickle charge the battery. (Page 2)
- PVC Conduit. (Page 7)
- The diameter of the post should be at least 6" in order to mount the post bracket. (Page 7)
- Depending upon the diameter of the post, you may need longer bolts than those provided. Bolts should be at least 1" longer than the diameter of the post. (Page 7)
- Metal plate for wooden posts. (Page 7)
- A horizontal or vertical cross members or mounting plates may be needed to mount the operators to the gates. (Page 3)
- Some types of installations require U-Bolts. (Page 11)
- Surge protection for transformer. (Page 18)
- Weatherproof cover for transformer if installed outside. (Page 18)
- For push-to-open applications you must have two (2) PTO Brackets Ⓢ [R4KPTO).

IMPORTANT:

The 4000XLS gate operator (6 ft. cable) will be installed on the gate on the same side of the driveway as the control box and they will be referred to as the MASTER gate and gate operator. The 4200XLS gate operator (50 ft. cable) will be installed on the gate on the opposite side of the driveway from the control box and they will be referred to as the SECOND gate and gate operator throughout this manual.

9. Installation Overview

Pull-To-Open Gates (Gate Opens into the Property)

The diagram shown below is an example of a Pull-To-Open installation on a chain link fence and dual gate. Mounting the operators on masonry columns requires special procedures; see Column Installation Information on page 27. Furthermore, if you have a Push-To-Open gate, see Push-to-Open Installation on page 25 before proceeding.

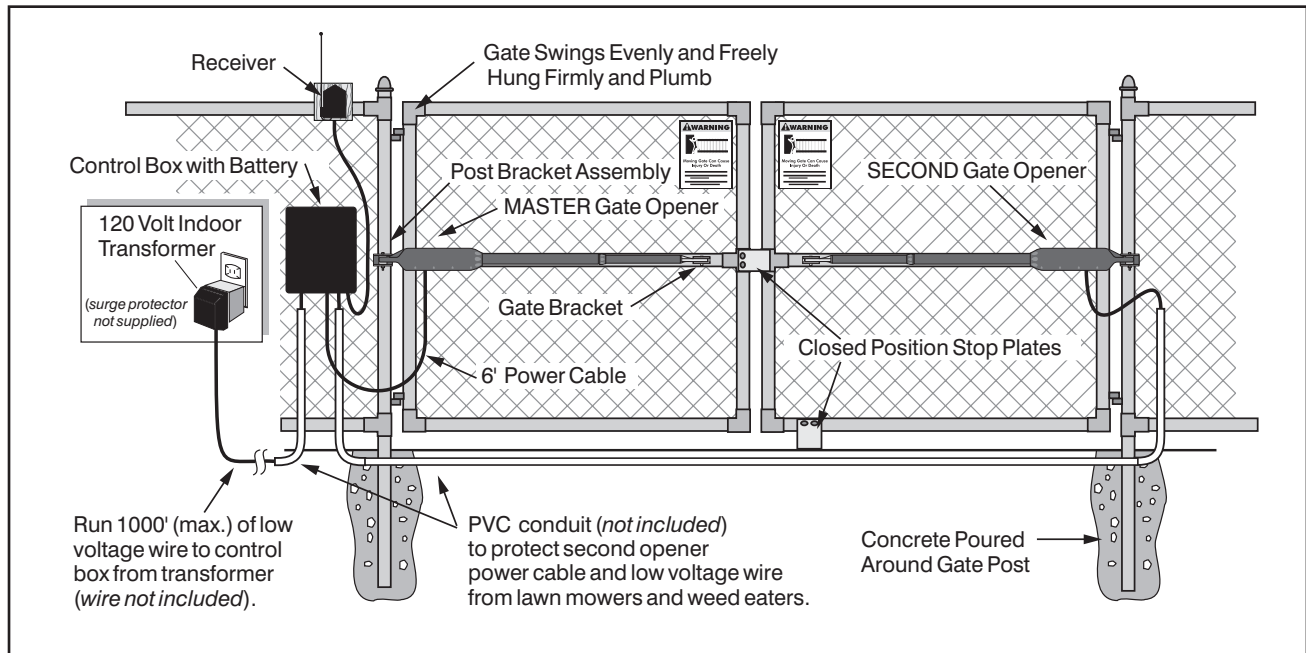

Install the Master Gate Operator (4000XLS)

Install the Post Bracket Assembly

The post bracket is designed to work on a flat post. Posts must be at least 6" square in order to bolt the post bracket. When using bolts to mount the post bracket, the bolts must completely penetrate the post.

- The best method of attaching the post bracket to a metal post is welding.
- If your post exceeds 8", it will be necessary to use hex head bolts longer than those supplied.
- Round wood posts (no smaller than 8" diameter) may be notched to create a flat surface for attaching the post bracket.
- Wood posts will require a metal plate (not provided) between the nuts and post to prevent the operator from pulling the bolts and washers through the wood.
- A post smaller than 6" in diameter should be made of metal instead of wood so that it will remain stable while the operator is moving the gate.
- Masonry columns will require masonry anchors/hardware (not provided).

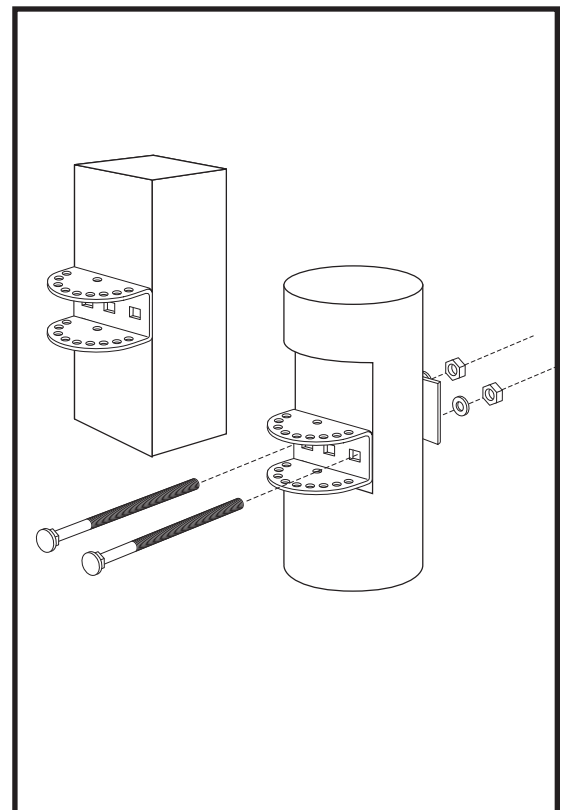

Step 1

Close the gate and place your level against the horizontal cross member. Position the level so that the top should be in the center of the cross member and overlaps the post. Scribe a line across the cross member and post. You will use this line to help determine position of post and gate brackets.

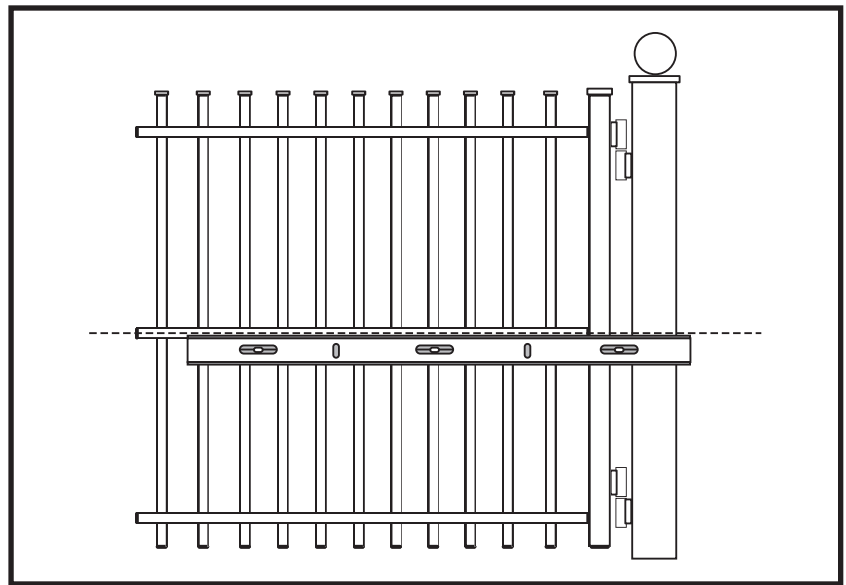
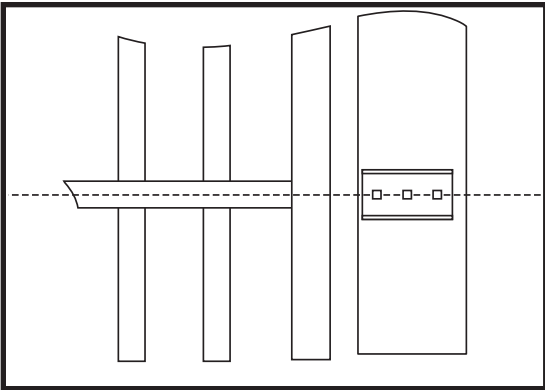

Step 2

Position the post bracket on the post with the mounting holes centered over the scribe line. The post bracket should be flush with the edge of the post closest to the gate. Mark the position of post bracket holes on the post.

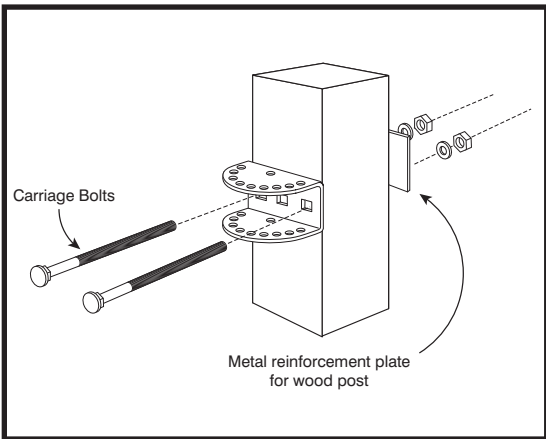

Step 3

Drill holes through post as marked using a 1/2" drill bit. Install the post bracket using the 1/2" x 10" carriage bolts, 1/2" flat washers and lock nuts (provided).

Step 4

Place the end of post pivot bracket with two holes inside the post bracket. Align the back hole in the post pivot bracket with back hole in the post bracket. Insert 3/8" x 3 3/4" hex head bolt and washer through post pivot bracket and post bracket and secure with 3/8" washer, and lock nut.

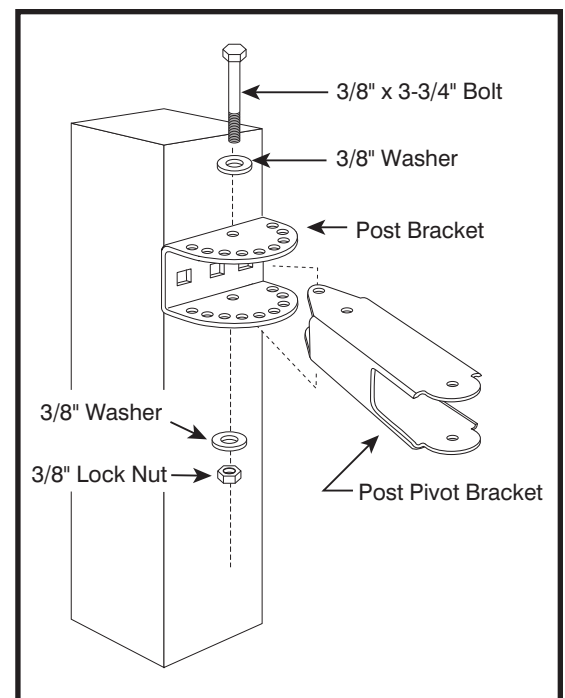

Step 5

Position the operator rear mount between post pivot bracket. Place a $\frac{1}{2}$ " bushing above the rear mount and a $\frac{3}{16}$ " bushing under the rear mount. Align the hole in rear mount, bushings and post pivot bracket and secure with the $3\frac{1}{2}$ " clevis pin and hair pin clip.

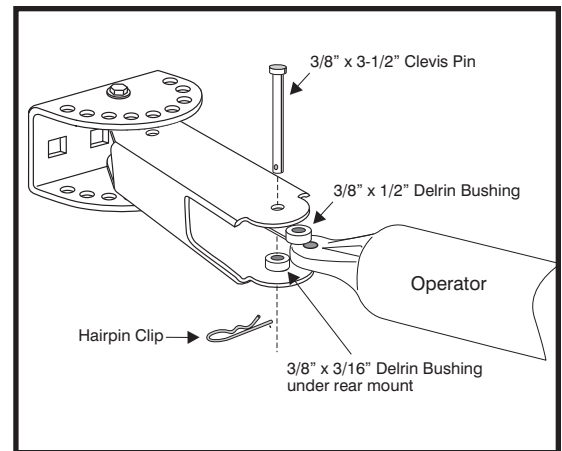
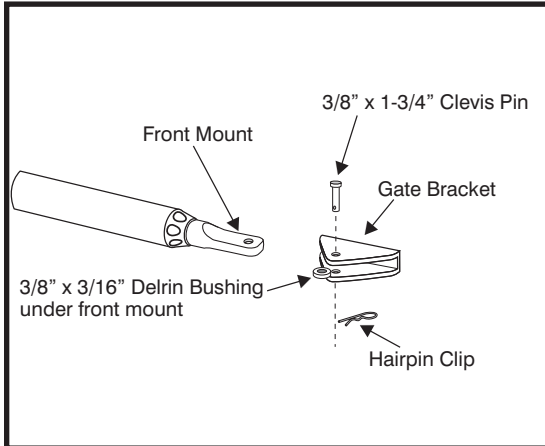

Step 6

Place a $\frac{3}{16}$ " bushing under the front mount and attach the gate bracket to the front mount using the $1\frac{3}{4}$ " clevis pin and hairpin clip.

Check Clearance

Step 7

Open the gate to the desired open position. Position the operator so that the gate bracket rests against the gate along the level scribed line. Check the clearance between the operator and the gate. The operator should only make contact with the gate at the gate bracket. There should be a minimum clearance of 2" between the widest part of the operator arm and the gate.

When you have achieved the best position for the post pivot bracket in the open position, insert the $\frac{3}{8}$ " x $3\frac{3}{4}$ " bolt and $\frac{3}{8}$ " flat washer through the aligned holes of the post bracket and post pivot bracket to hold it in place.

Clamp the gate bracket to the gate using c-clamps or another type of clamp.

IMPORTANT: While determining the position of the post pivot bracket, be sure that the position allows for minimum 2" of clearance between the gate and the operator in both the open and closed positions. This clearance will give the operator the most efficient leverage point for opening and closing the gate and, more importantly, provides the least possible pinch area.

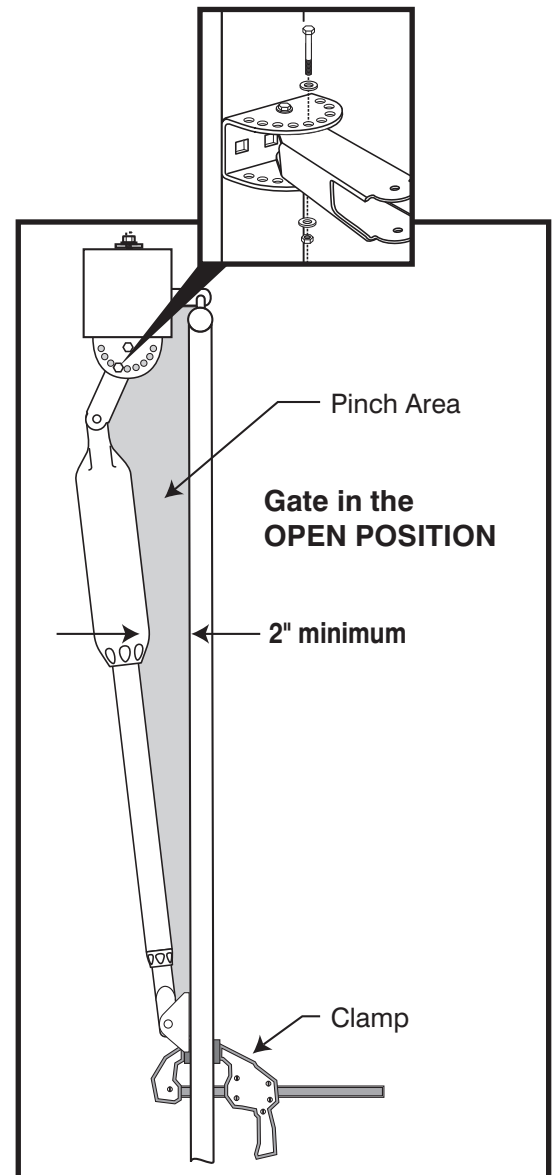

Step 8

Remove the clevis pin from the front mount and while supporting the gate operator, swing the gate and gate operator to the closed position. With the gate and gate operator in the closed position check the clearance and be sure that the gate operator is not binding at the post pivot bracket.

If you don't have 2" clearance or the gate operator is binding on the post pivot bracket, remove the bolt in the post bracket and readjust the pivot bracket until you can achieve the proper clearance.

With the post pivot bracket in the optimum position for clearance and freedom of movement, replace the bolt in a post bracket adjustment hole and secure with 3/8" washer, and lock nut. Return the operator to the open position and reattach the gate bracket. Recheck the gate operator level and clearance in the open position. Adjustment of the gate bracket will be necessary if the post bracket was moved. After verifying clearance, make sure the gate bracket is clamped securely.

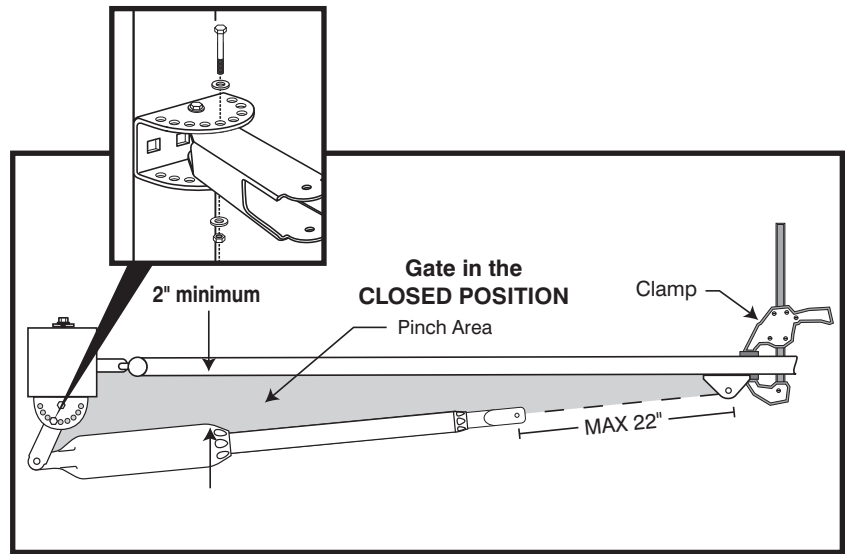

Install Gate Bracket

Step 9

Detach the front mount from the gate bracket. Check that the gate bracket holes are centered over the scribe line. Mark the gate in the center of the gate bracket holes. Remove the gate bracket and drill the 1/2" holes through the gate cross member and attach the gate bracket using the 1/2" x 2 3/4" bolts, washers and lock nuts.

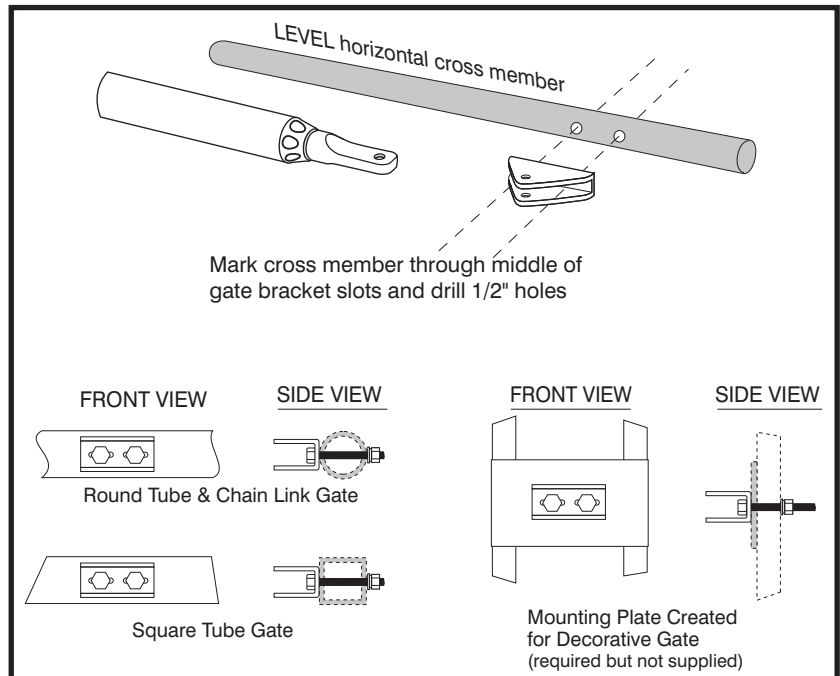

Attach Operator

Step 10

Make sure the gate is in the open position and the operator arm is fully retracted. Attach the operator to the securely bolted post bracket assembly and gate bracket using clevis pins, bushings, and hairpin clips, or optional Pin Lock [FM345]. Verify that the operator is level, bolts are tight, and adjust the post bracket assembly if necessary.

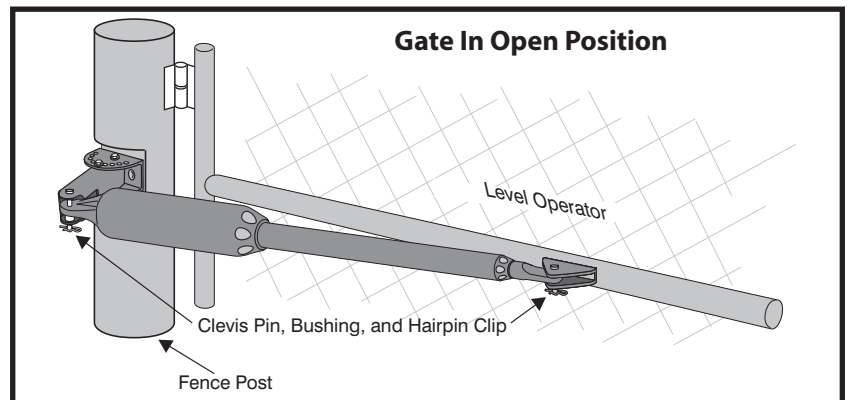

Install the Second Gate Operator (4200XLS)

The hardware installation for the 4200XLS is the same as the 4000XLS - follow Steps 1 to 10 on pages 8 - 10 to install the 4200XLS on the second gate.

Install the Closed Position Stops

The 4000XLS/4200XLS Gate Operators firmly hold the gates in the closed position using positive stops. The positive stops help stabilize the gate leaves in the closed position. To further enhance stability and security, we strongly recommended using an optional GTO Automatic Gate Lock.

IMPORTANT: The gate and gate operator on the same side as the control box will be referred to as the MASTER gate and gate operator. The gate and gate operator on the opposite side of the driveway from the control box will be referred to as the SECOND gate and gate operator.

Note: Ground stop required for GTO automatic gate lock.

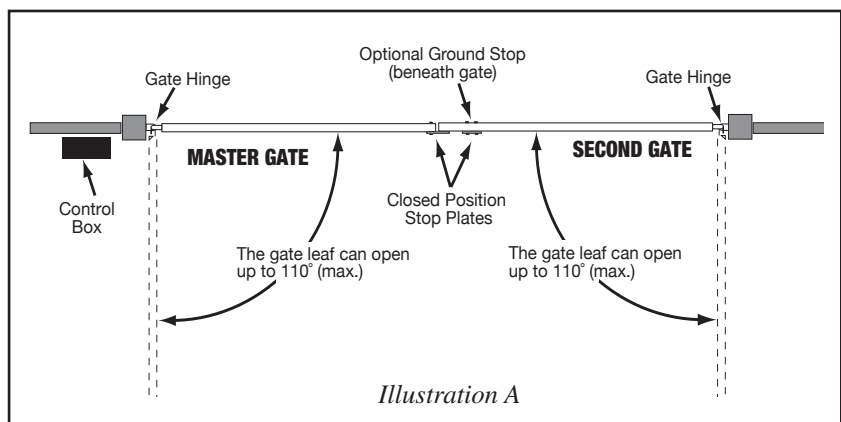

Step 1

Detach the gate operators from the gates and move the gates to their closed position (Illustration A). Using appropriate hardware for your type of gate (U-bolts for tube or chain link; screws or bolts for wood or metal) attach the closed position stop plate (horizontally) in line with the operator arm, about mid height on the MASTER gate frame. Do not tighten it completely at this time. Slide the stop plate toward the frame of the SECOND gate leaf until they touch (Illustration B). Once you have moved the stop plate to the correct position, tighten its hardware completely.

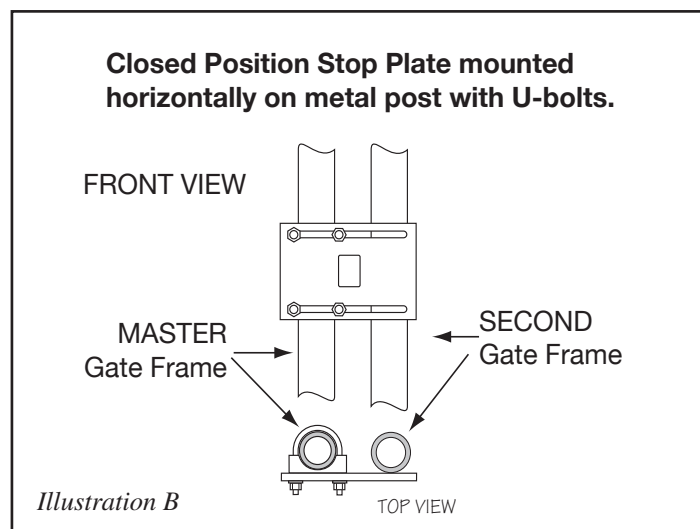

NOTE: The optional ground stop post is used to provide a secure point for the SECOND gate to close against. If you will be using the GTO Automatic Gate Lock accessory with your gate operator system, the low profile ground stop is REQUIRED, as example shown in Illustration C.

Step 2

Install a low profile ground stop (not provided) beneath the SECOND gate stop plate.

The ground stop needs to be positioned near the end of the gate as shown in *Illustration A* and may be made of metal or concrete and should be firmly secured in the ground (we recommend setting it in concrete).

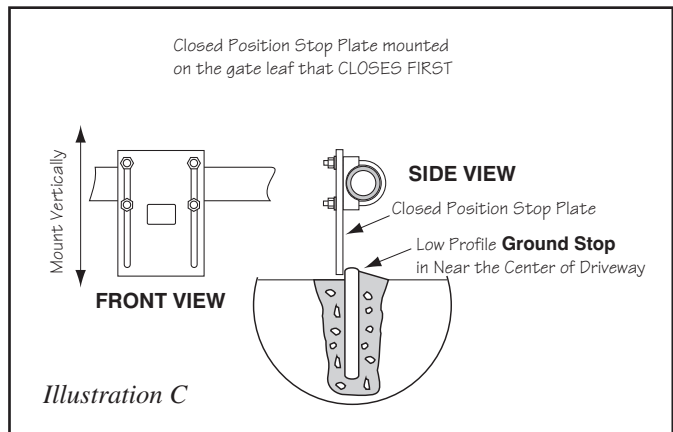

Step 3

Attach a vertical closed position stop plate to the SECOND gate.

Using appropriate hardware for your type of gate attach the vertical closed position stop plate to the SECOND gate frame at the point where it will come in contact with the ground stop post. Do not tighten it completely at this time. You must slide the closed position stop plate toward the ground stop until they touch (*Illustration C*). Once you have moved the stop plate to the correct position, tighten its hardware completely.

NOTE: For a **push-to-open** installation (gate opens out from the property) attach the closed position stop plates to the outside of the gate.

Step 4

Return gates to the open position and reattach gate operators.

Mount the Control Box and Receiver

Step 1

Mount the control box using the screws (provided) or another secure mounting method. The control box must be mounted at least 3 feet above the ground to protect it from rain splash, snow, etc., and at least 3 feet from an AC power source to prevent electrical interference.

Step 2

Temporarily mount the receiver at this time.

NOTE: You will use the transmitter (page 21) to check the range of the receiver before permanently mounting it. You may have to try different locations before permanently mounting the receiver. The receiver range can vary from 50 to 100 feet depending upon weather, topography, and external interference.

Mount the receiver:

- Ensuring a line-of-sight between transmitter and antenna.
- At least 3 feet away from AC voltage.
- As high as possible for optimum range.
- DO NOT mount receiver upside down.
- DO NOT mount receiver directly to metal fence or metal post (this will decrease signal range). Use a piece of wood between receiver and metal surface.

The receiver cable:

- Cable length is 10 ft. (receivers with longer cables are available as special order items; call the GTO Sales Department).
- NEVER splice receiver cable!
- Run the receiver cable through PVC conduit to protect it from damage.
- DO NOT run cable in conduit containing AC wiring.

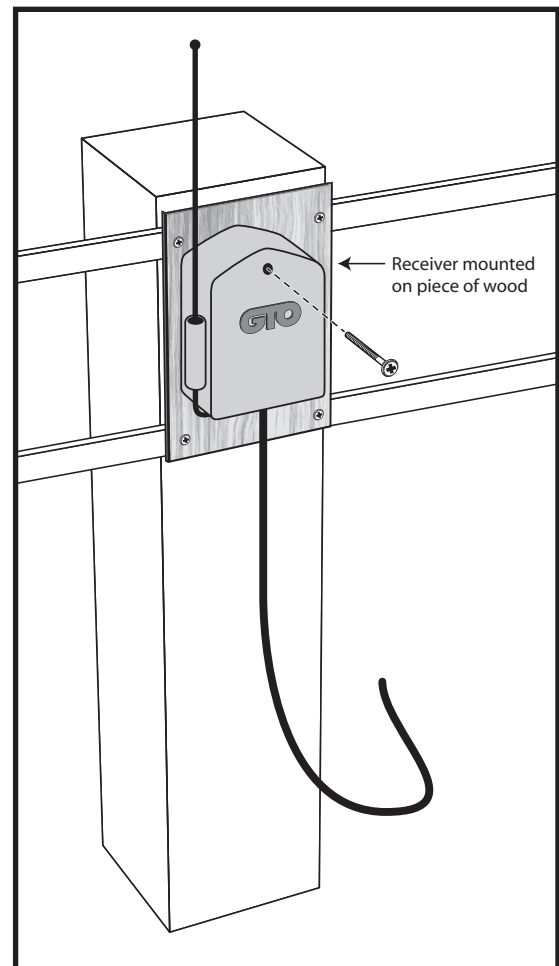
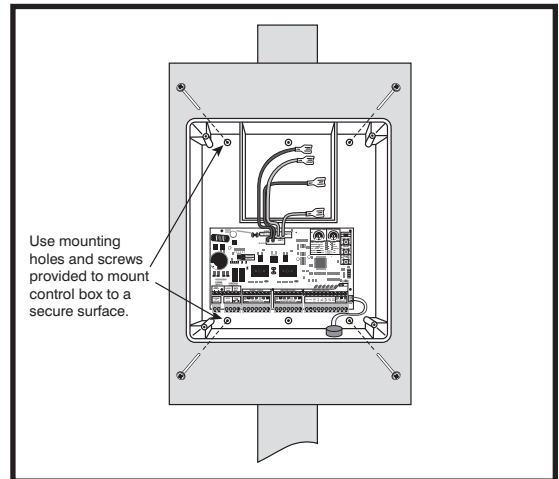

This device complies with FCC rules Part 15. Operation is subject to the following conditions:

1. This device may not cause harmful interference.
2. This device must accept an interference that may cause undesired operation.

Transmitter distance may vary due to circumstances beyond our control. **NOTE:** The manufacturer is not responsible for any radio or TV interference caused by unauthorized modifications to this equipment. Such modifications could void the user's authority to operate the equipment.

Connect Operator Power Cables

Step 1

Review the Installation Overview illustration below before proceeding.

Cut a slot into the driveway to accommodate 3/4" PVC conduit (not provided). The buried conduit will protect the SECOND operator power cable from automobile tires, lawn mower blades, weed eaters, and grazing animals. Pull the SECOND operator power cable through the conduit, up to the Control Box.

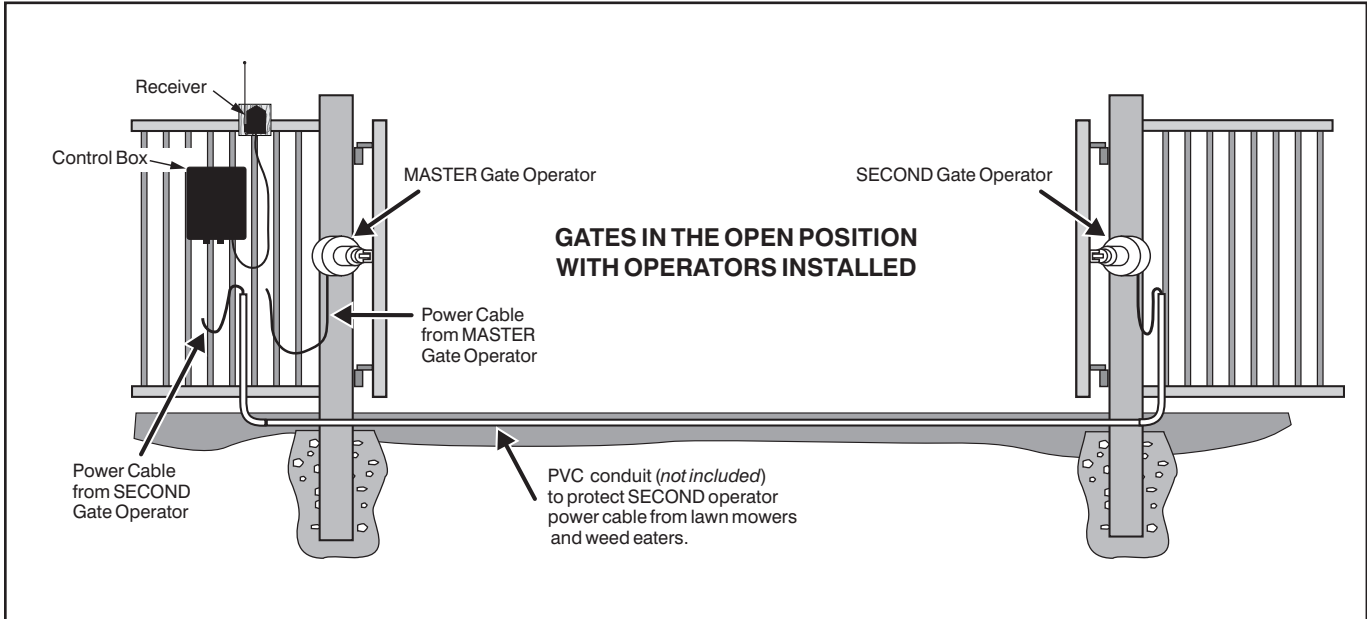

Step 2

Loosen sealing nuts on strain relief hubs at bottom of control box. Insert power cables into control box through strain reliefs. Thread approximately 6" of the power cables into the control box and retighten sealing nuts until the power cables lock into place.

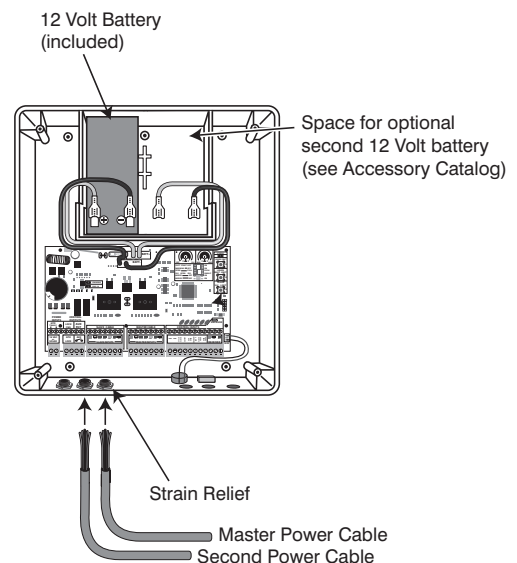
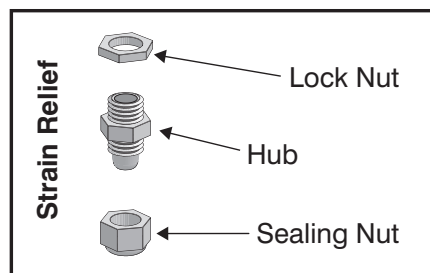

Connecting MASTER Operator

Step 3

Insert the stripped power cable wires into the appropriate terminals on the MASTER OPERATOR terminal block. The green wire should be inserted into the GRN terminal, the white wire into WHT, the blue wire into BLUE, brown wire into BRN, orange wire into ORG, red wire into RED, and the black wire into the BLK terminal.

Tighten the set screws against the end of the wires.

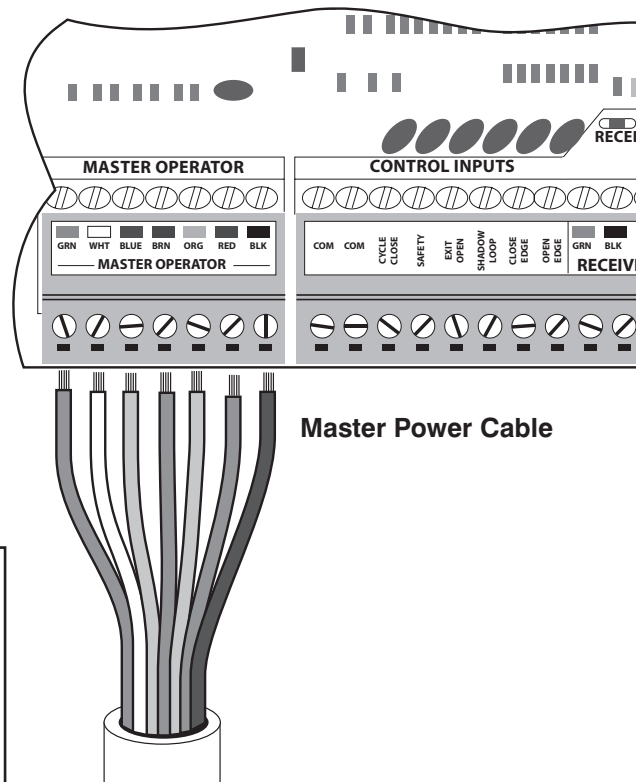

NEVER SPLICE WIRES. Splicing permits corrosion and seriously degrades the wire's ability to carry an adequate current.

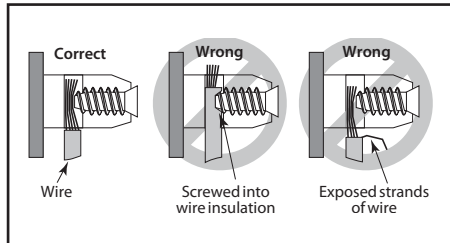

Connecting SECOND Operator

Step 4

Insert the stripped wires of the power cable into the appropriate terminals on the SECOND OPERATOR terminal block. The green wire should be inserted into the GRN terminal, the white wire into WHT, the blue wire into BLUE, brown wire into BRN, orange wire into ORG, red wire into RED, and the black wire into the BLK terminal.

Tighten the set screws against the end of the wires.

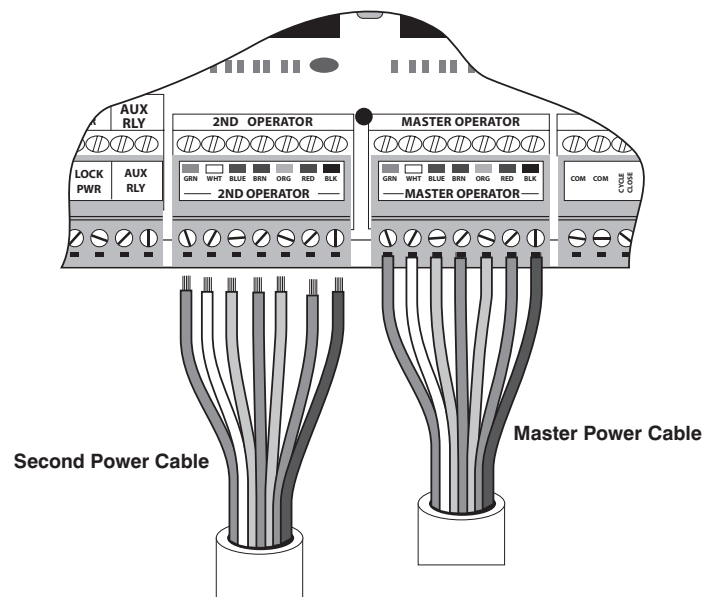

Connect the Power Input

IMPORTANT:

- The transformer is designed and intended for indoor use. If the transformer can only be plugged into an outside electrical outlet, a weatherproof cover/housing (available at local electrical supply stores) must be used.
- The only wire acceptable for use with GTO products is 16 gauge stranded, low voltage, direct burial wire ☞ [RB509]. This particular gauge enables the transformer to provide an adequate charge through the control board to the battery at distances up to 1000 ft.
- DO NOT use telephone wire or solid wire.
- NEVER splice wires. Splicing permits corrosion and seriously degrades the wire's ability to carry an adequate current.
- **NEVER USE TRANSFORMER AND SOLAR PANEL(S) AT THE SAME TIME! Doing so will damage the control board.**
- If your gate is more than 1000 ft. from an AC power source, you will need to use at least 10 watts solar charging power ☞ [FM122/FM123] to charge the battery. Refer to the Solar Panels and Gate Activity Chart on page 2.

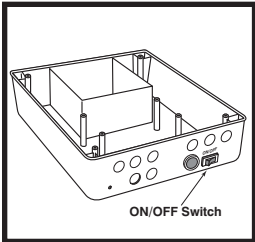

Step 1

Make sure the control box power switch is OFF.

Step 2

Select the electrical outlet into which you will plug the transformer. Measure the distance from this outlet to the control box following the path where the wire will be laid (allow for an additional 6" to be pulled into the control box).

Step 3

Lay the low voltage wire in a trench following a path from the selected electrical outlet to the control box. Wires coming up from the ground should be run through PVC conduit to protect them from lawn mower blades, weed eaters, and grazing animals. Bury the wire in the trench.

Step 4

Feed the low voltage wires upward through the strain relief opening on the lower left of the control box. Pull 6" to 8" of wire into the control box.

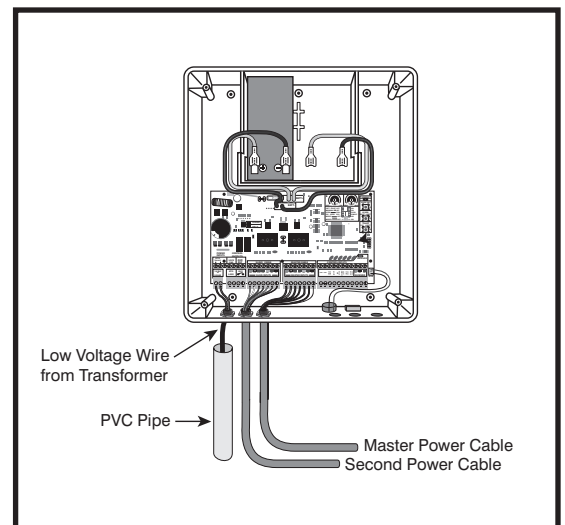

Step 5

Strip the ends of the low voltage wire and twist tightly. Attach these ends to the **18 VAC or SOLAR** terminals located on the POWER INPUTS terminal block. **Be certain not to let the exposed wires touch each other!**

Insert one transformer wire into an **18 VAC or SOLAR** terminal. Insert the other transformer wire into the remaining **18 VAC or SOLAR** terminal. The transformer wires can be connected to the **18 VAC or SOLAR** terminals regardless of color/polarity.

Tighten set screws against exposed end of wires.

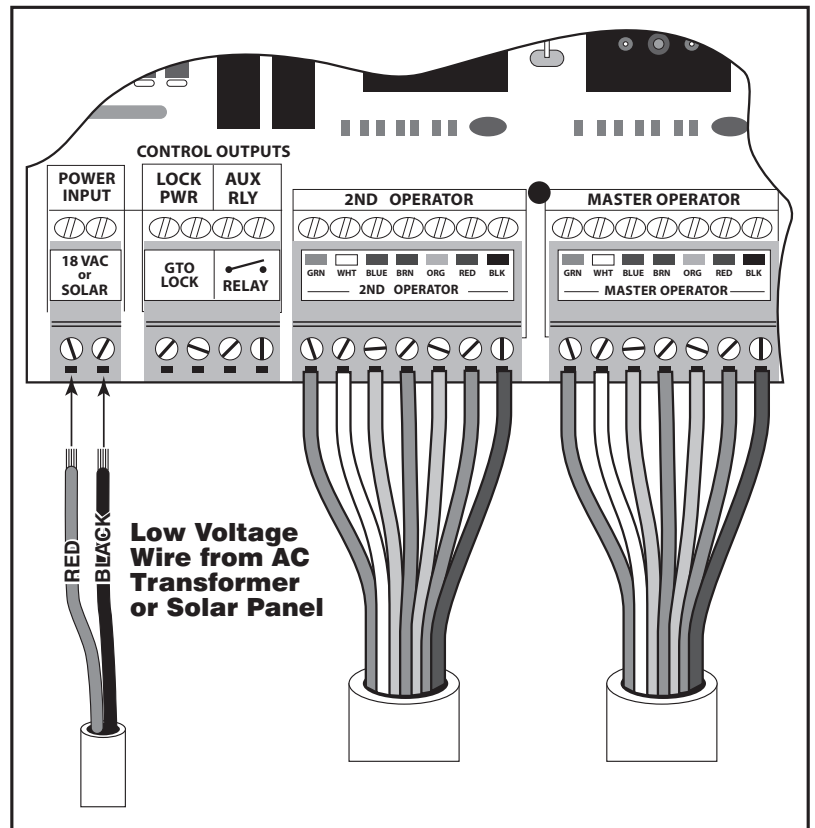
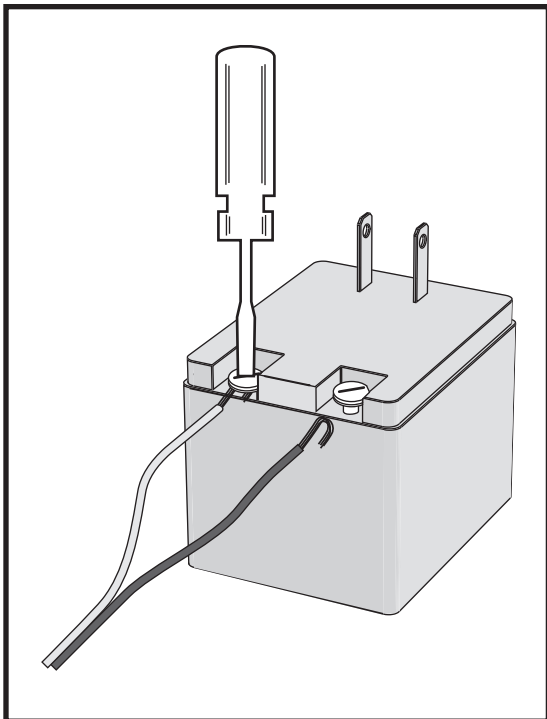

Step 6

At the transformer, strip 1/2" of insulation from the ends of the low voltage wire. Twist tightly and attach wires to the transformer terminals.

Make sure the exposed wires do not touch each other!

DO NOT PLUG THE TRANSFORMER INTO AN OUTLET DURING THIS STEP! THE TRANSFORMER MUST ONLY BE PLUGGED INTO AN OUTLET DURING STEP 3 (page 18)!

Connect Battery

Step 1

Make sure the control box power switch is OFF. Remove the control box cover and slide the battery into position (terminals to the right).

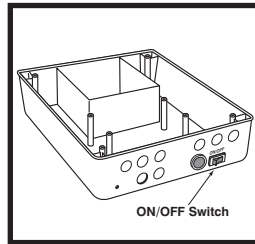

Step 2

IMPORTANT: Connect the BLACK battery wire to the NEGATIVE (-) battery terminal. Connect the RED battery wire to the POSITIVE (+) terminal. **Reverse connection of wires will damage the control board.**

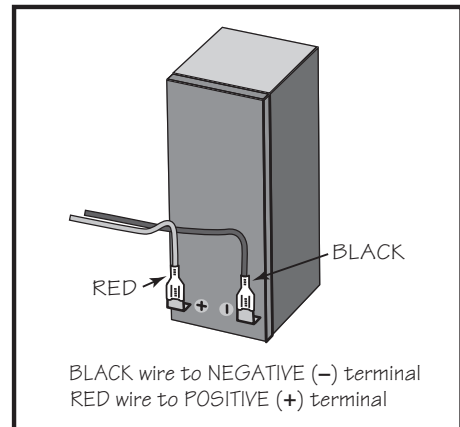

Step 3

Plug the transformer into the electrical outlet. (Use of a surge protector with the transformer is strongly recommended.)
IMPORTANT: This is a class II indoor transformer; if using transformer outdoors be sure to enclose it in a weatherproof case.

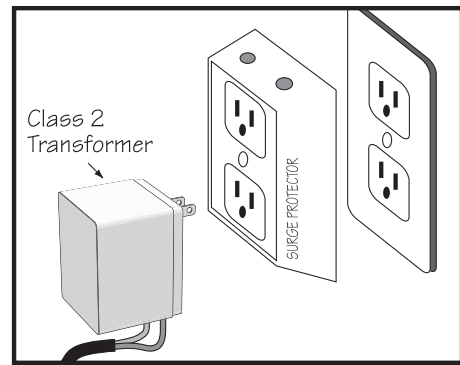

Control Board Settings

Set Closed Position Limit (for Pull-To-Open Applications)

Step 1

Power switch is on, gates are in the **OPEN** position, operator arms fully retracted.

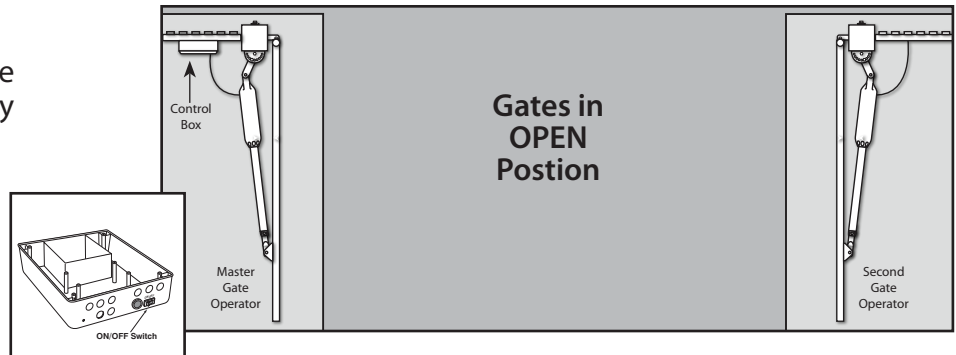

Step 2

Press the transmitter to activate operator arms. The gates will begin to **CLOSE**.

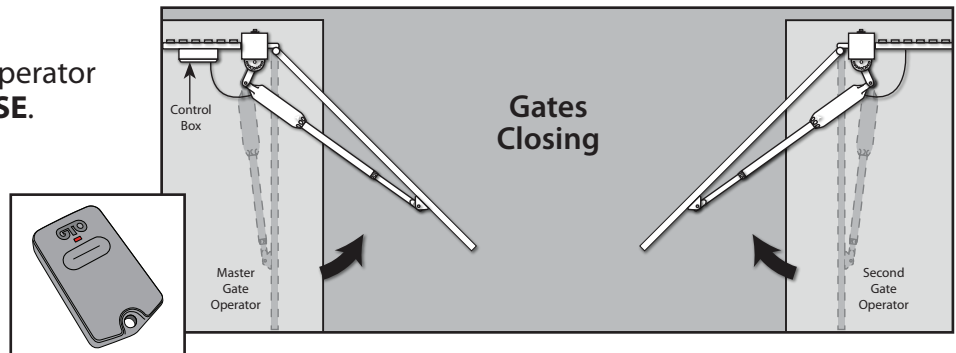

Step 3

When either gate reaches **CLOSED** position, press transmitter to stop the gates.

- A. If the master gate reaches closed position first - press and hold LEARN MAST LIMIT for 5 seconds, or until buzzer beeps to set closed position.
- B. If the second gate reaches closed position first - press and hold LEARN 2ND LIMIT for 5 seconds, or until buzzer beeps to set closed position.

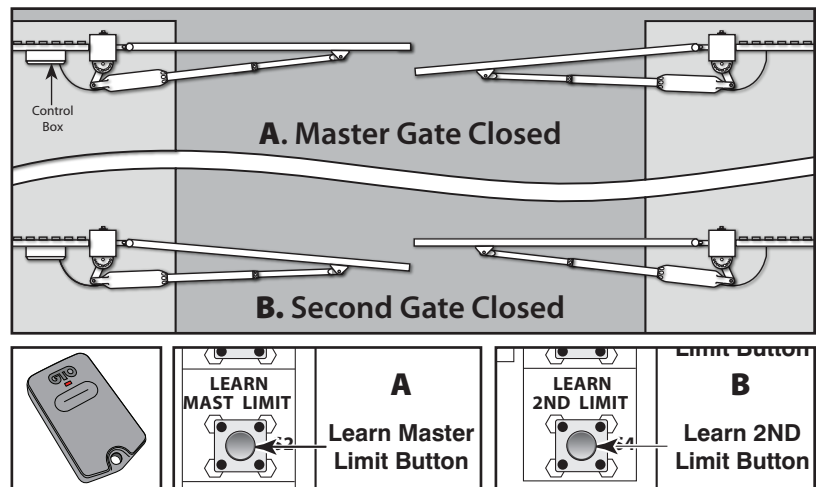

Step 4

Press the transmitter to open the gates. Gates will **OPEN** fully. The gate in Step 3A or 3B is now programmed.

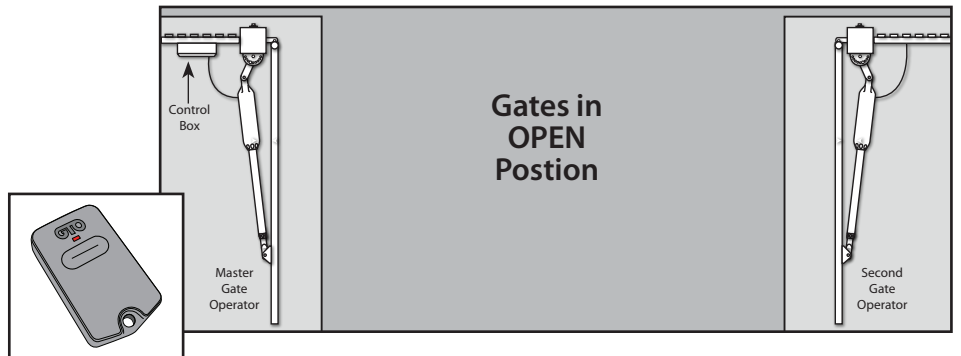

Step 5

Press the transmitter to activate operator arms. The gates will begin to **CLOSE**.

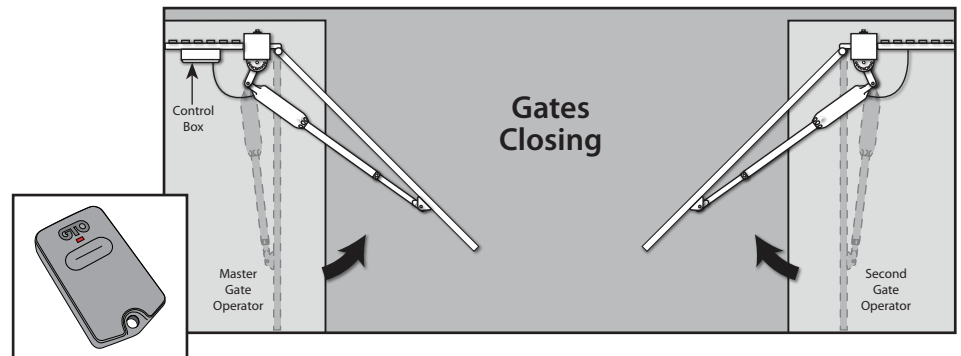

Step 6

The gate that was programmed in step 4 will stop on its own. Press the transmitter again to stop the other gate when it reaches the desired **CLOSED** limit.

- A1. Master gate reaches closed position. - press and hold LEARN MAST LIMIT for 5 seconds, or until buzzer beeps to set closed position. (Master gate is now programmed)
- B1. 2nd gate reaches closed position - press and hold LEARN 2ND LIMIT for 5 seconds, or until buzzer beeps to set closed position. (Second gate is now programmed)

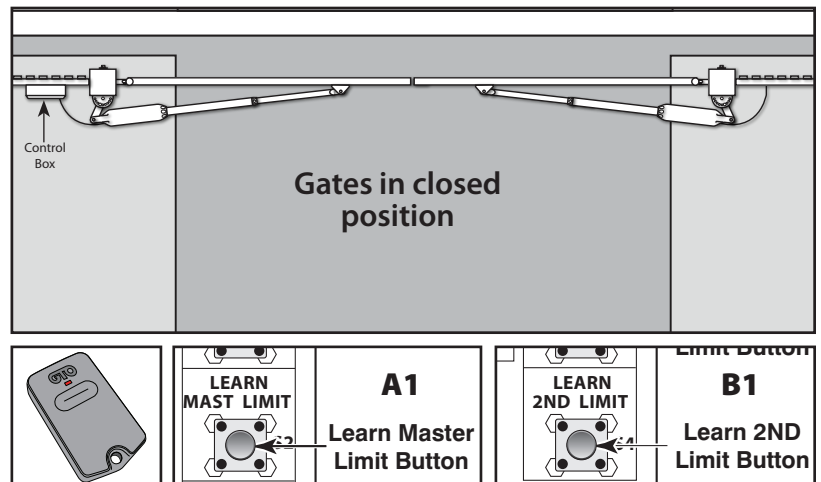

Step 7

Press the transmitter once again to **OPEN** gates.

Both gates closed position are now programmed.

If you make a mistake and set the limit at the wrong position: press your transmitter to return the gates to the fully opened position, then press and hold the LEARN MAST LIMIT and/or the LEARN 2ND LIMIT button for 5 seconds. This will clear the memory for the closed limit position. Repeat Steps 1-6.

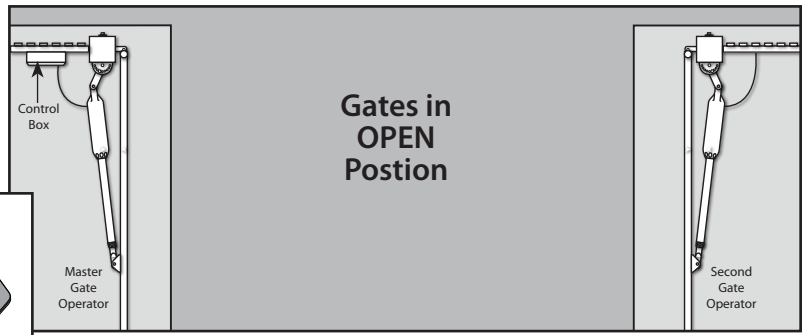
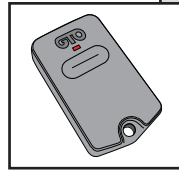

Adjust the Stall Force Setting

The Stall Force potentiometer on the control board controls the obstruction sensitivity (or the amount of force the operator will apply to an obstruction for two (2) seconds before it automatically stops and reverses direction).

IMPORTANT: For safety reasons the stall force setting will need to be adjusted for your particular application.

The Stall Force potentiometer on the control board operates like a volume control on a radio. Use a small flat blade screwdriver to adjust the potentiometer. Adjust the stall force from the MIN position until the gate operates smoothly without obstructing from its own weight or wind conditions.

NOTE: you may need to increase the stall force in cold temperatures due to increased resistance from gate hinges.

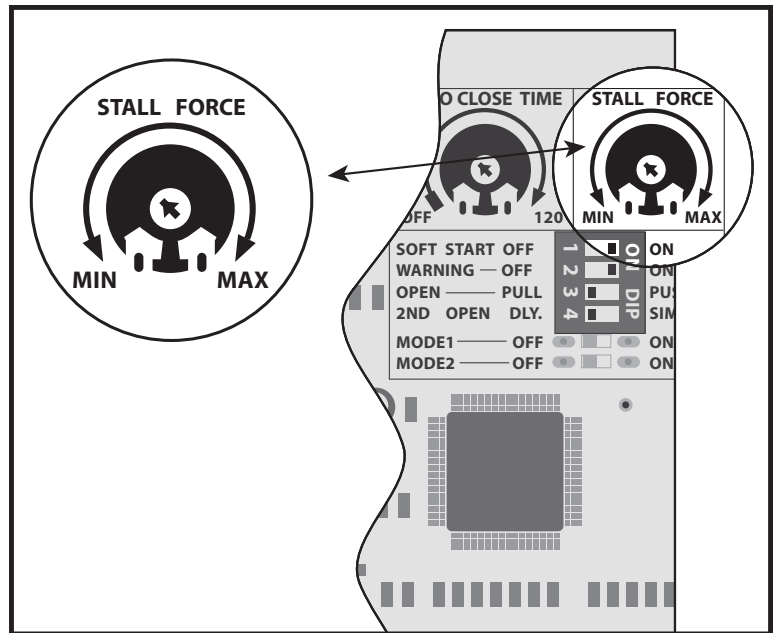

Set Auto Close Time

The Auto-Close Time potentiometer controls the Auto-Close feature, and determines how long the gate will remain open (at the fully open position) before it begins to close. The settings for this feature are OFF, or from 3 to 120 seconds.

Adjust the Auto-Close potentiometer by using a small flat blade screwdriver.

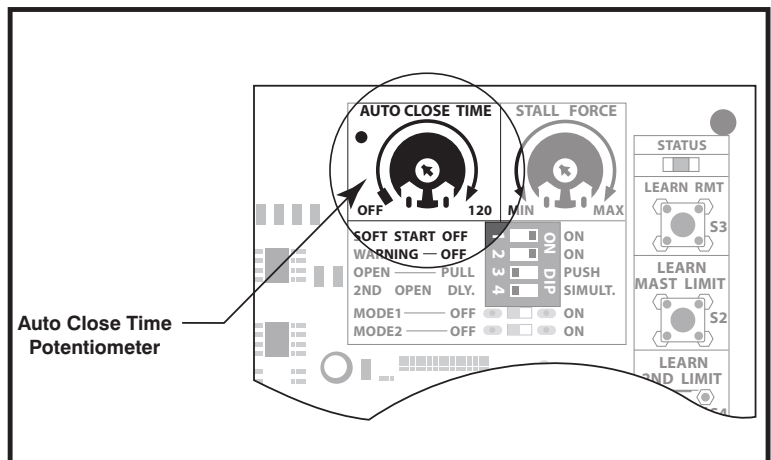

Program Your Personal Transmitter Setting

All GTO transmitters are set to a standard code at the factory and are ready to operate your GTO gate operator. For your safety and security, **we strongly recommend** that you replace the factory setting with your own personal setting. Follow the directions below:

NOTE: If you have multiple transmitters, you should adjust all of them at this time. ☺ [RB741/RB742/RB743].

Step 1

Use a small phillips head screw driver to remove the transmitter cover.

Step 2

Set the transmitter DIP switches using a small screwdriver. There are nine (9) switches; each can be placed in three different positions (+, 0, -). **DO NOT** set all the switches in the same position, such as all +, all 0, or all -. Once the DIP switches have been reset, replace and close the access cover.

WARNING: No other adjustments should be made inside the transmitter.

Step 3

Program the new setting into the control board:

- Press and hold transmitter button.
- Press and hold the LEARN RMT (Learn Remote) button on the control board until the alarm sounds.
- Release transmitter button. The new code is stored in control board memory.
- Release the LEARN RMT (Learn Remote) button.

NOTE: If you have purchased additional transmitters, program the settings for all at this time.

Step 4

AT THIS POINT YOU SHOULD TEST RECEIVER RANGE BEFORE PERMANENTLY INSTALLING IT.

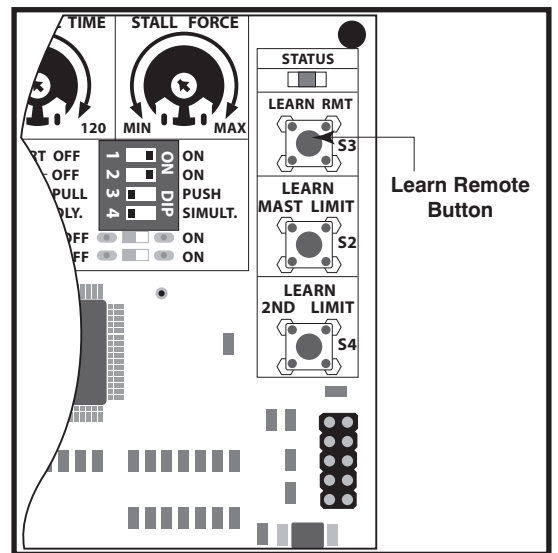
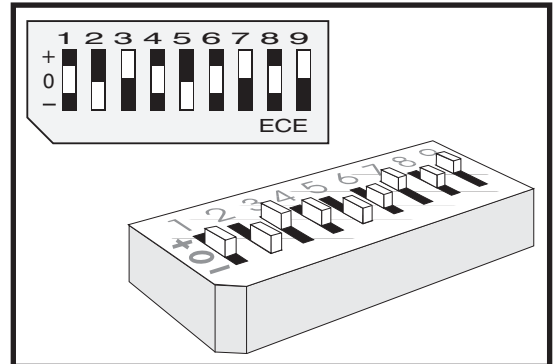
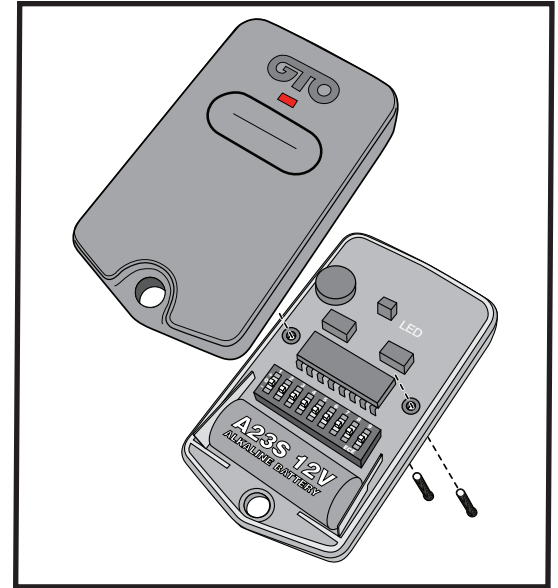

The Troubleshooting Wizard has detailed information this and other installations.

24/7 Troubleshooting Wizard: <http://support.gtoinc.com>

DIP Switch Settings

DIP Switches

DIP Switch Settings (MODES)

DIP Switch #1: Soft Start/Stop

ON– Soft start enabled (factory preset).

OFF– Soft start disabled.

The Soft Start/Stop feature slowly starts the gate as it begins to open and slows the gate as it comes to the closed position. This saves wear and tear on the gate and gate operator system.

DIP Switch #2: Warning Buzzer

ON– Buzzer warning enabled (factory preset).

OFF– Buzzer warning disabled.

The Warning Buzzer alerts you when the gate operator is beginning to either open or close the gate. It sounds for the first 2 seconds in each direction. It also sounds a warning when the gate obstructs two times in one cycle. Switching this to OFF only disables the open and close warning not the obstruction warning.

DIP Switch #3: Push/Pull-to-Open

ON– Push-to-open.

OFF– Pull-to-open (factory preset).

If your gate opens into the property the DIP Switch is set to the OFF position (factory setting). If your gate opens out from the property the DIP Switch must be set to the ON position. NOTE: if you have a Push-to-Open gate application you will need a Push-to-Open bracket (see Push-to-Open Instructions on page 25).

DIP Switch #4: Dual Operation

ON– Second opens simultaneously with master.

OFF– Second opens after master. (factory preset).

Note: Not applicable for single gate operator.

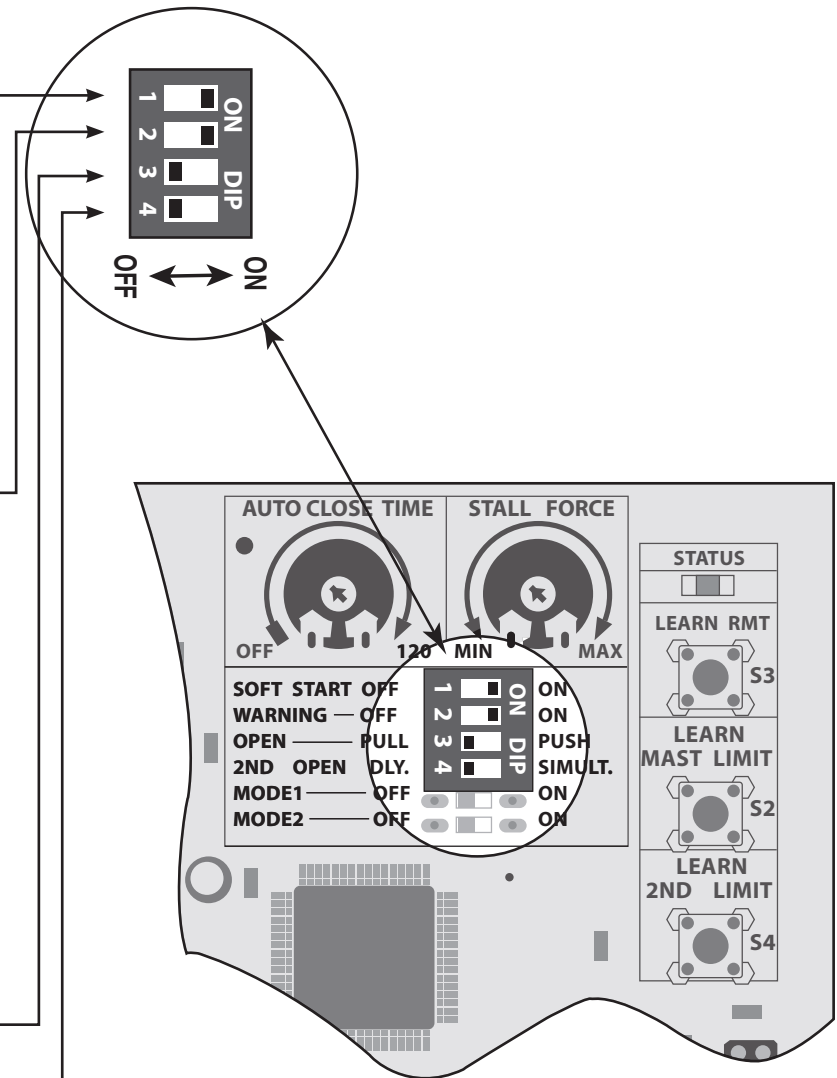

Connecting Accessories

Input Connections

- All control inputs are dry-contact, normally open, inputs. DO NOT apply external voltage sources to these inputs.
- All inputs are connected with respect to COMMON terminal.
- The status LED will blink once when its corresponding input is activated.

- 1 COM:** Circuit common (reference for all logic input)
 - Two (2) terminals to provide extra common connection point.
- 2 CYCLE/CLOSE:** (Typically for use with push button or hard-wired keypad)
 - Each activation at this input will cycle the operation as follows:
OPEN–STOP–CLOSE–STOP–OPEN
- 3 SAFETY:** (Typically for use with photo beam device, loop detector or other non-contact sensors)
 - Activation of this input while the gate is closing will cause the gate to stop and return to the opened position.
 - Activation of this input while the gate is opening has no effect (gate will continue to open).
 - Activation of this input while gate is idle will prevent gate from closing.
- 4 EXIT/OPEN:** (Typically for use with exit loop or wand)
 - Activation of this input will open the gate if it's not already at the open position.
 - Activation of this input while at open limit will restart the auto close time (if enabled).
 - Activation of this input while gate is idle will prevent gate from closing.
- 5 SHADOW LOOP:** (Typically for use with loop detector)
 - This input is only monitored when the gate is at the fully open position. At any other position, activation of this input has no effect on gate operation.
 - Activation of this input while gate at the fully open position will prevent gate from closing.
- 6 CLOSE EDGE:** (Typically for use with safety edge device)
 - Activation of this input while the gate is closing will cause the gate to stop and reverse direction for approximately 2 seconds.
 - Activation of this input while the gate is opening has no effect (gate will continue to open).
 - Activation of this input while gate is idle will prevent gate from closing.
- 7 OPEN EDGE:** (Typically for use with safety edge device)
 - Activation of this input while the gate is opening will cause the gate to stop and reverse direction for approximately 2 seconds.
 - Activation of this input while the gate is closing has no effect (gate will continue to close).
 - Activation of this input while gate is idle will prevent gate from opening.

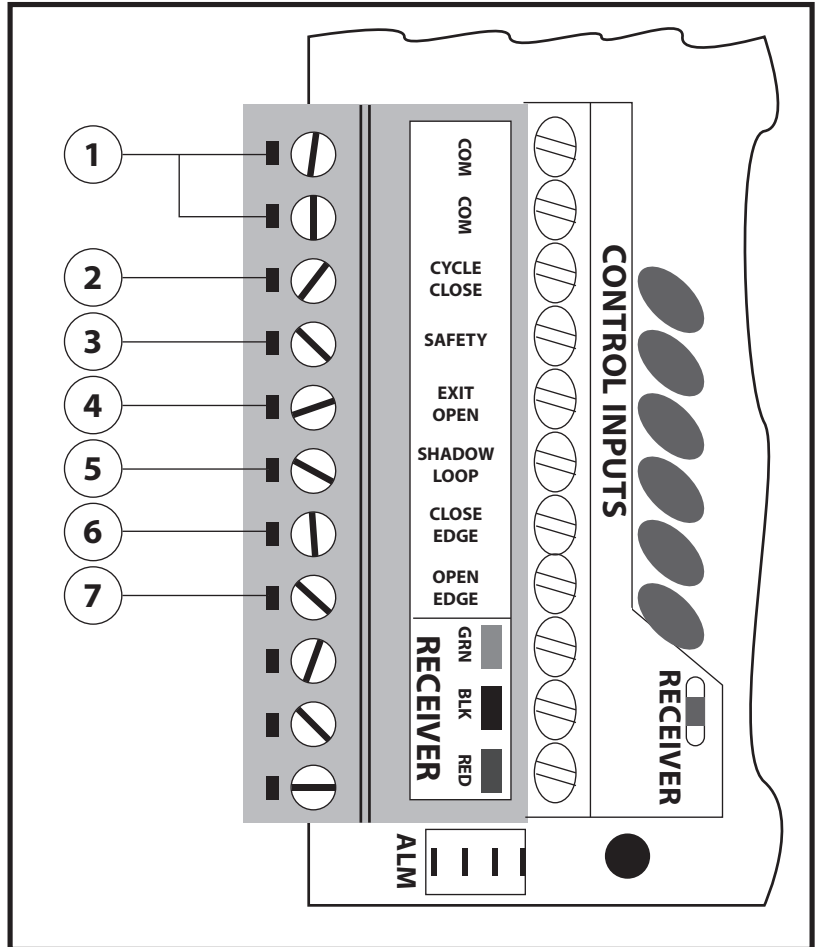

Wiring Accessories

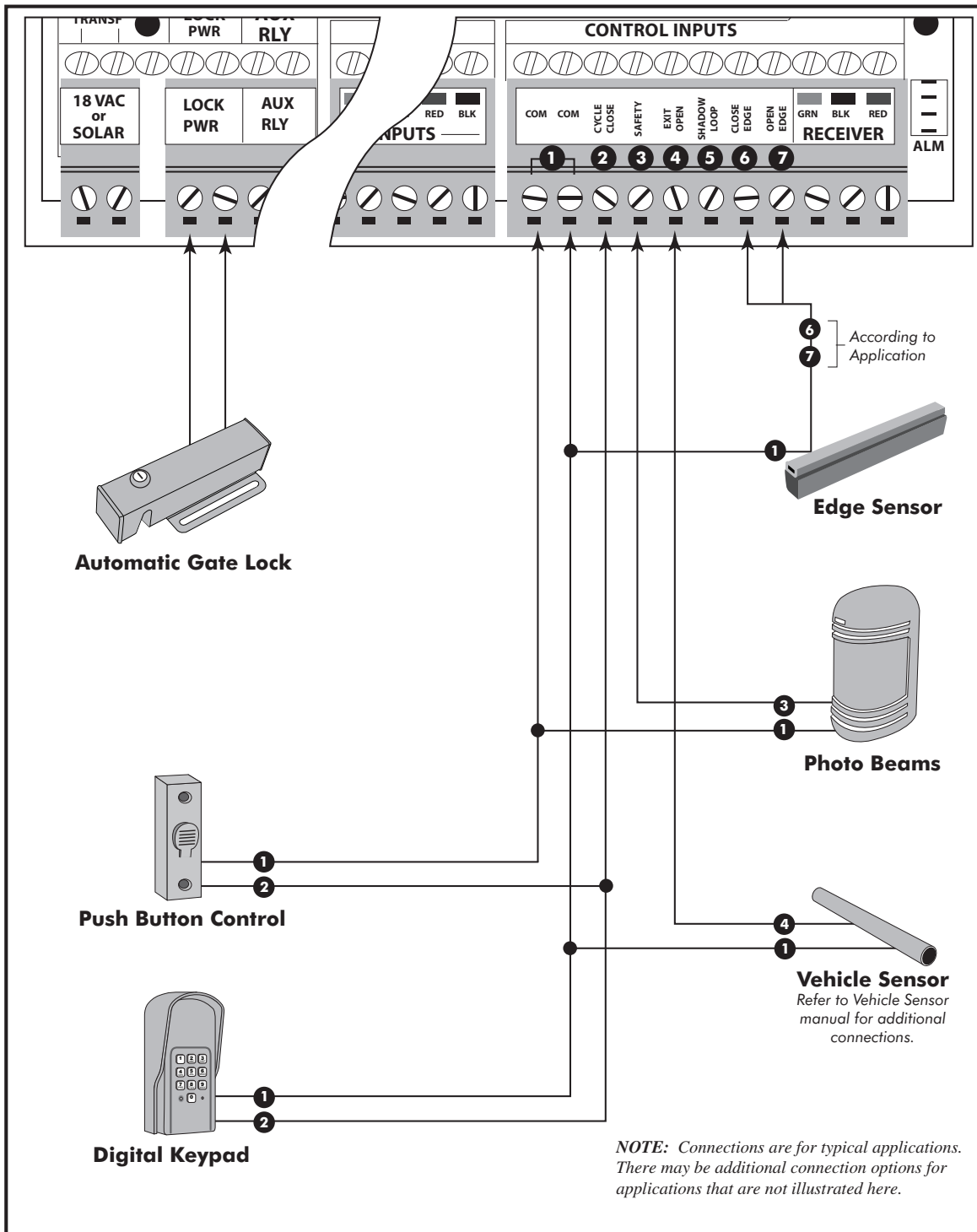

Connecting Other Auxiliary Devices (Sirens, Lights, etc.)

- These 2 terminals are normally open "dry-contact" (no voltage) relay output.
- Relay is closed when gate is in motion; relay is open when gate is not moving.
- These 2 terminals maximum rating is 24Vdc, 1 Amp.

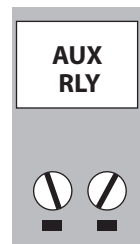

Push-To-Open Installation Information

Swinging gates shall not open into public access areas!

A "Push-to-Open" gate opens out from the property (operator arm extends to open the gate). A Push-To-Open installation requires the purchase of a Push-To-Open Bracket [R4KPTO].

In a Push-To-Open installation the operator is installed while the gate is in the CLOSED POSITION.

Install the Operator

Follow directions for installing the 4000XLS beginning on page 7. *The Push-To-Open installation differs from the Pull-To-Open installation in the following ways:*

1. In a Push-To-Open installation, the arm fully extends to open the gate, and it fully retracts to close the gate. (C)
2. You will install the operator while the gate is in the **CLOSED POSITION (arm fully retracted)**. (A)
3. You must use the Push-to-Open Post Pivot Bracket [R4KPTO] in the Post Bracket assembly. (B)
4. **IMPORTANT:** While determining the mounting point for the post pivot bracket assembly be sure that the position allows for 2" clearance between the gate and the operator in both the open and closed positions (see diagram below). This clearance will give the operator the most efficient leverage point for opening and closing the gate and more importantly provides the least possible pinch area. (C)

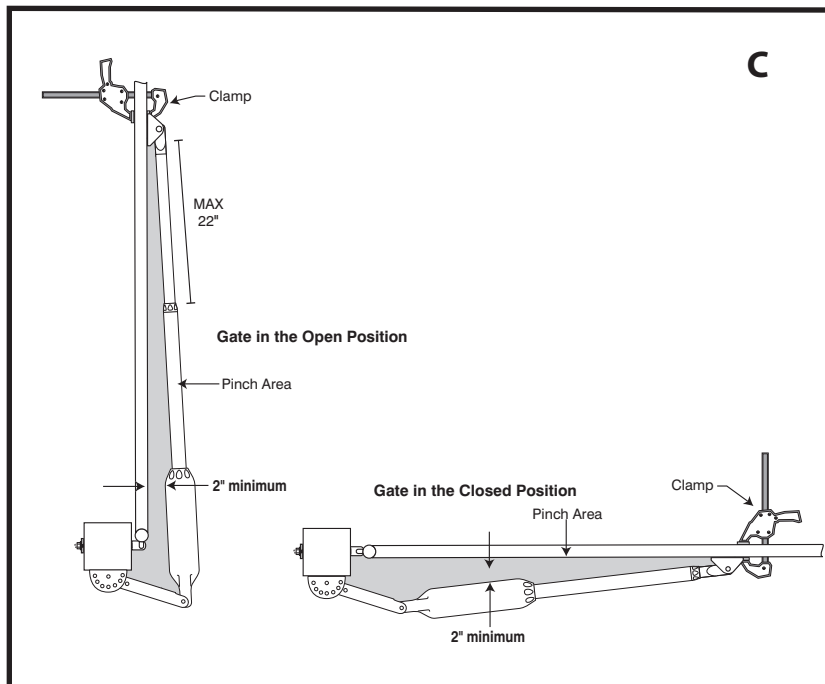
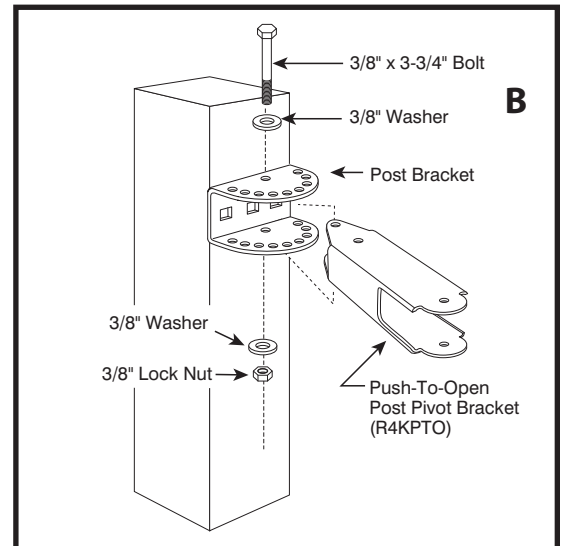
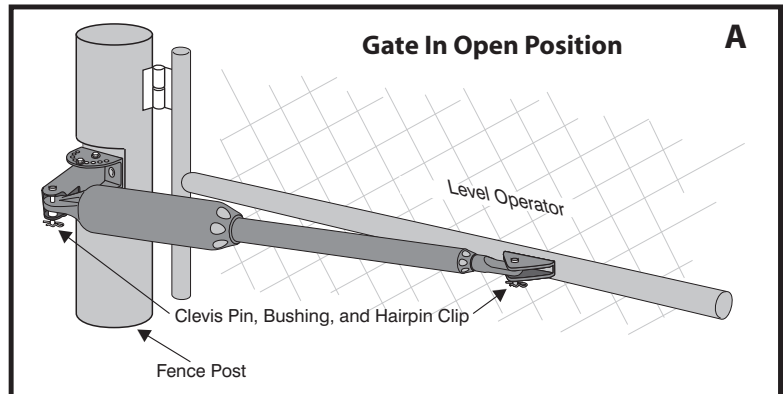

Install the 4200XLS Operator

Now install the SECOND gate operator on the SECOND gate in the same manner.



The Troubleshooting Wizard has detailed information on Push-To-Open Installations.

24/7 Troubleshooting Wizard: <http://support.gtoinc.com>

Set Control Board for Push-To-Open

Make sure the control box power switch is OFF. Use a small screwdriver to move the Number 3 DIP switch from the factory setting (OFF / Pull-To-Open) to ON for Push-To-Open. Turn power switch ON. The control board is now configured to push the gate open.

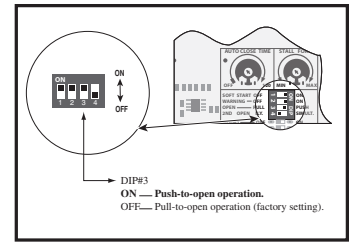

Setting the Open Position Limit (Push-To-Open Installations)

Step 1

Power switch is on, gates are in the **CLOSED** position, operator arms fully retracted.

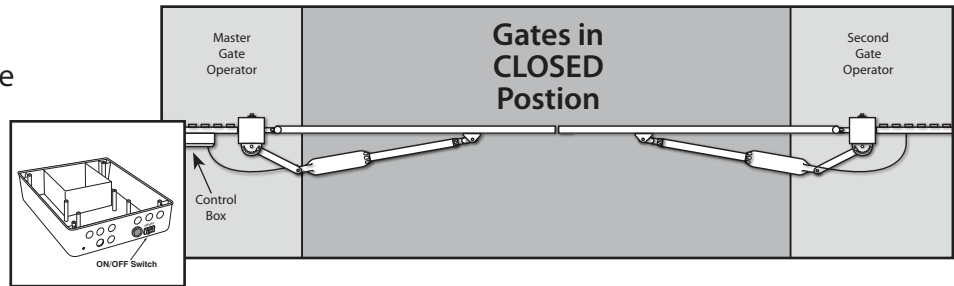

Step 2

Press the transmitter to activate operator arms. The gates will begin to open.

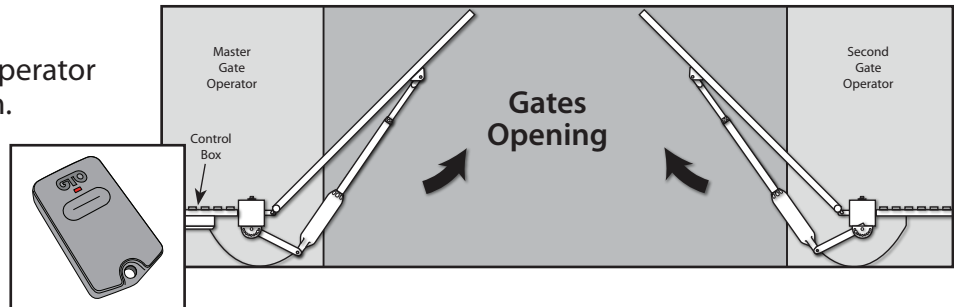

Step 3

When either gate reaches **OPEN** position, press transmitter to stop the gates.

A. If the **master gate** reaches open position first - press and hold LEARN MAST LIMIT for 5 seconds, or until buzzer beeps to set open position.

B. If the **second gate** reaches open position first - press and hold LEARN 2ND LIMIT for 5 seconds, or until buzzer beeps to set open position.

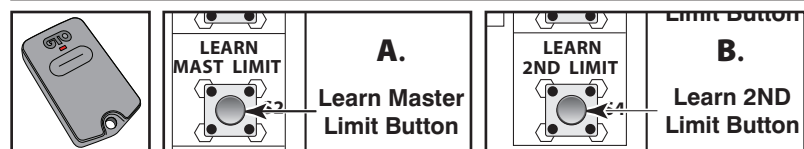
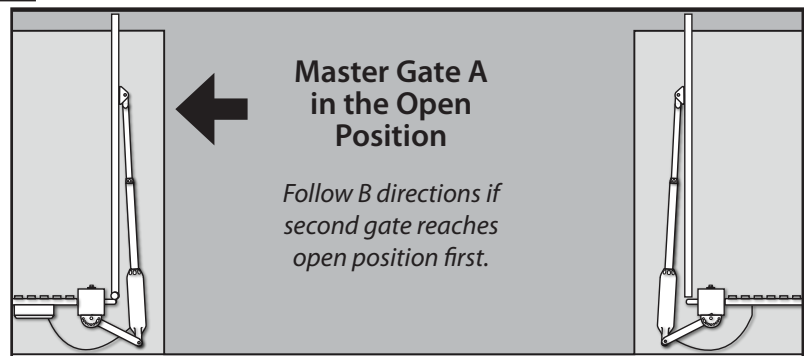

Step 4

Press the transmitter to **CLOSE** the gates. Gates will close fully. The gate in Step 3A or 3B is now programmed.

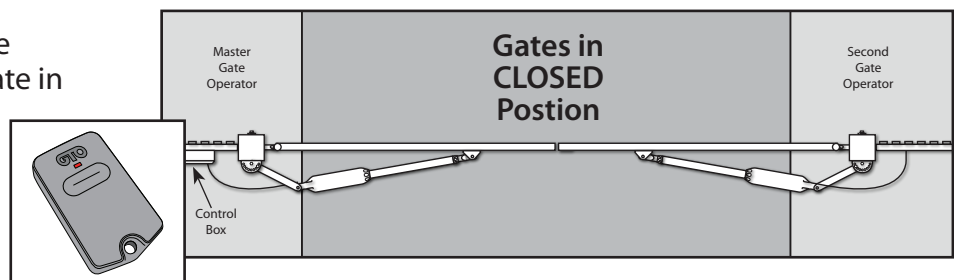

Step 5

Press the transmitter to activate operator arms. The gates will begin to **OPEN**.

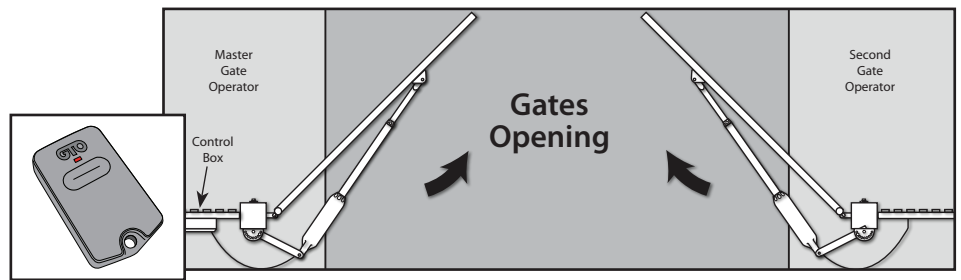

Step 6

The gate that was programmed in step 4 will stop on it's own. Press the transmitter again to stop the other gate when it reaches the desired **OPEN** limit.

A1. Master gate reaches open position. - press and hold LEARN MAST LIMIT for 5 seconds, or until buzzer beeps to set open position. (Master gate is now programmed)

B1. Second gate reaches open position - press and hold LEARN 2ND LIMIT for 5 seconds, or until buzzer beeps to set open position. (Second gate is now programmed)

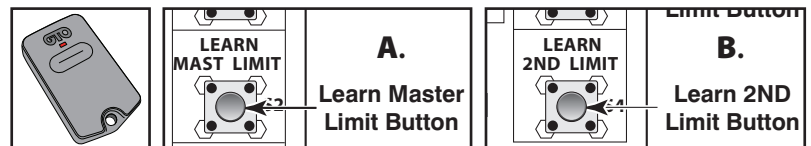
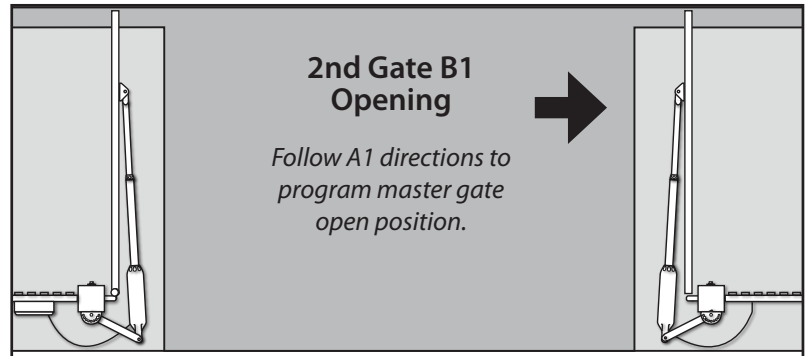

Step 7

Press the transmitter once again to close gates. Both gates open position are now programmed.

If you make a mistake and set the limit at the wrong position: press your transmitter to return the gates to the fully closed position, then press and hold the LEARN MAST LIMIT and/or the LEARN 2ND LIMIT button for 5 seconds. This will clear the memory for the open limit position. Repeat Steps 1-6.

Column Installation

If this operator will be used with gates that are mounted on masonry, brick, or rock (etc.) columns, read the following carefully before proceeding

- The simplest solution is to install the operator in a push-to-open configuration. The minimum clearance is easier to achieve and clearance is no longer a problem, since the operator will be pushing the gate away from the column instead of pulling it toward the column. It is recommended that you place a steel plate between the operator mounting brackets and masonry surface for additional strength.
- If a push-to-open installation is impossible due to traffic hazards, terrain, etc., another option is to re-hang the gate. You may hang it on a post, either in the center of the column or at the back corner, or move the gate to the back corner of the columns.
- The most difficult solution is to cut a notch in the column to accommodate the operator and power cable. This job is NOT for the inexperienced!*

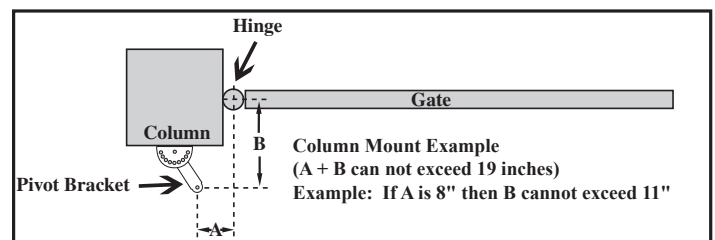

*The Troubleshooting Wizard has detailed information on column mounting.

Troubleshooting Guide

If your gate operator does not function properly after it is installed, use this guide before calling the GTO Service Department.

Generation 3 Audible Feedback

SYMPTOM	DIAGNOSIS	CHECK:
1 short beep upon power up	Circuit Board Powered Up & Ready	<ul style="list-style-type: none"> • Normal Operation
1 short beep upon activation	Blown Fuse Low or Bad Battery Loose Battery Connection	<ul style="list-style-type: none"> • Fuse • Battery Under Load • Battery Harness Connections
Continuous Uninterrupted Alarm	Circuit Board Senses an Obstruction	<ul style="list-style-type: none"> • Path of Gate • Gate for Level and Plumb • Stall Force Adjustment • Disconnect Safety Devices • Rev Counter
1 beep with 10 seconds off	Low Battery Condition	<ul style="list-style-type: none"> • Fuses • Battery Harness Connections • Battery Under Load
1 beep then 2 beeps	Master Motor Terminals Shorted	<ul style="list-style-type: none"> • Connections to Master Inputs • Master Arm Power Cable • Motor • Circuit Board
1 beep then 3 beeps	Second Motor Terminals Shorted	<ul style="list-style-type: none"> • Connections to Second Inputs • Second Arm Power Cable • Motor • Circuit Board
1 beep with 2 seconds off	Master Arm Limit Switch Error	<ul style="list-style-type: none"> • Connections to Master Inputs • Master Arm Power Cable
2 beeps with 2 seconds off	Second Arm Limit Switch Error	<ul style="list-style-type: none"> • Connections to Second Inputs • Second Arm Power Cable
3 beeps with 2 seconds off	Master Arm Rev Counter Error	<ul style="list-style-type: none"> • Connections to Master Inputs • Master Arm Power Cable • Rev Counter
4 beeps with 2 seconds off	Second Arm Rev Counter Error	<ul style="list-style-type: none"> • Connections to Second Inputs • Second Arm Power Cable • Rev Counter

Generation 3 Visual Feedback

SYMPTOM	DIAGNOSIS	CHECK:
Status (clear) 1 blink	Cycle Terminal Shorted	<ul style="list-style-type: none"> • Disconnect the push button, keypad, intercom keypad, or any other accessory wired to this terminal. • Try the remote. If the remote works, then the problem is the accessory.
Status (clear) 2 blinks	Safety Terminal Shorted	<ul style="list-style-type: none"> • Disconnect the loop detector, photo beam, or any other accessory wired to this terminal. • Try the remote. If the remote works, the problem is the accessory.
Status (clear) 3 blinks	Exit Terminal Shorted	<ul style="list-style-type: none"> • Disconnect exit wand, loop detector, photo beam, or any other accessory wired to this terminal. • Try remote. If the remote works, the problem is the accessory.
Status (clear) 4 blinks	Shadow Terminal Shorted	<ul style="list-style-type: none"> • Disconnect the loop detector, photo beam, or any other accessory wired to this terminal. • Try remote. If the remote works, the problem is the accessory.
Status (clear) 5 blinks	Close Edge Terminal Shorted	<ul style="list-style-type: none"> • Disconnect the edge sensor, photo beam, or any other accessory wired to this terminal. • Try the remote. If the remote works, the problem is the accessory.
Status (clear) 6 blinks	Open Edge Terminal Shorted	<ul style="list-style-type: none"> • Disconnect edge sensor, photo beam, or any other accessory wired to this terminal. • Try the remote. If the remote works, the problem is the accessory.
RF (yellow) Flickers	Receiving 318 MHz RF	<ul style="list-style-type: none"> • Normal operation when remote or wireless keypad is used.
RF (yellow) OFF	No 318 MHz RF Received	<ul style="list-style-type: none"> • Battery in Remote • Program Remote • Antenna Receiver Connections • Antenna Receiver
Power (green) ON	AC or Solar Power Present	<ul style="list-style-type: none"> • Normal Operation

VOLTAGE READINGS

18 Vac Transformer	18.0 to 22.0 Vac
10 W Solar panel (single)	18.0 to 22.0 Vdc
<i>In FULL SUN — measure voltage with the Solar Panel Disconnected.</i>	
12 V, 7 amp hour Battery	12.5 to 13.5 Vdc
or Two 12V, 7 amp hour Batteries if using solar power	
<i>Measure voltage at battery terminals with battery disconnected</i>	
Charging circuit	12.0 to 14.8 Vdc
<i>Measure voltage at battery terminals with battery connected</i>	

Repair Service

If your GTO 4000XLS/4200XLS Gate Operators are not operating properly, please follow the steps below:

1. First use the procedures found in the Troubleshooting Guide (see page 28).
2. Use the 24/7 Troubleshooting Wizard at <http://support.gtoinc.com>.
3. If you are unable to solve the problem, call the GTO Service Department at (800) 543-1236, or (850) 575-4144. Refer to the serial number (located on the right side of the control box) and date of purchase when calling for assistance.
4. If repair or replacement of your gate operator is necessary, the Service Department will assign a Return Goods Authorization (RGA) number to you.
5. Once you have received your RGA# you are required to send in your original equipment for repair. Please refer to Manufactures' Limited Warranty for complete details. Securely pack the component(s) authorized for return to the factory. Include a copy of your sales receipt for the purchase of the product(s). Write the RGA number issued to you on the outside of the package in **LARGE BOLD PRINT**.

Ship the package(s) freight prepaid to: GTO, 3121 Hartsfield Road, Tallahassee, Florida, USA 32303.

NOTE: Products returned to GTO without a Return Goods Authorization (RGA) number in LARGE BOLD PRINT on the outside of the package WILL NOT be accepted. Also, items returned to GTO freight collect WILL NOT be accepted.

GTO Technical Service

8:00am–7:00pm • Monday–Friday (EST)



3121 Hartsfield Road • Tallahassee, Florida, USA 32303

(850) 575-0176 • Fax (850) 575-8912

Web site www.gtoaccess.com

 24/7 Troubleshooting Wizard: <http://support.gtoinc.com>

Accessories for 4000XLS/4200XLS

Please visit www.gtoaccess.com for photos and detailed descriptions of GTO Accessories. Or call 1-800-543-GATE (4283).

POWERING ACCESSORIES



Low Voltage Wire [RB509]

The 16 gauge, stranded, dual conductor low voltage Wire is for connecting the AC powered transformer, solar panel or wired accessories to the system's control board. This specially designed wire is UV treated, PVC coated, and ready for direct burial.

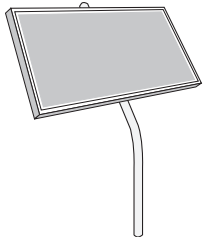

Solar Panel Kits [FM122/FM123]

If your gate operator is more than 1000 ft. away from an AC power outlet, you can choose to maintain the battery charge with the GTO Solar Panel Kit.

- 10 Watt Solar Panel Charging Kit [FM123]
- 5 Watt Solar Panel Charging Kit [FM122]



Additional/Replacement Battery [RB500]

For additional battery power or replacement.

"FROM VEHICLE" ENTRY AND EXIT ACCESSORIES

Transmitters [RB741/RB742/RB743]

Purchase an additional transmitter for each vehicle in your family. The Two-Button Transmitter can be programmed to operate both your gate operator and a garage door opener using the Universal Receiver. Or it can be programmed to open two gate operator systems.

- Single Button Transmitter [RB741]
- Dual Button Transmitter [RB742]
- Three Button Transmitter [RB743]



Universal Receiver [RB709U-NB]

The Universal Antenna Receiver gives you the ability to use one remote to activate your gate operator and your garage door opener. Connects to any brand garage door opener. Up to 100 ft. range.

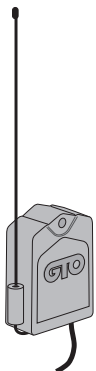

Digital Keypad [F310]

Allow friends access to your property using an identification code that you provide. Program up to 25 entry codes for added security. Powered by three "AA" batteries (not included).

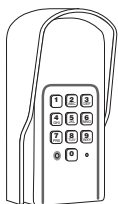

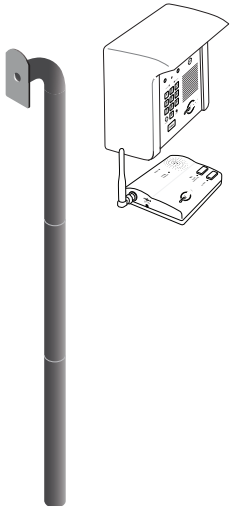

Residential Wireless Entry Intercom [F3100MBC]

Designed for added security to your automated gate with the ability to “speak to” and “screen” visitors safely from inside your home. Ideal for securing gate entrances while providing controlled access.

Gooseneck Pedestal [F100/F110]

Designed to mount digital keypads, wireless intercom systems, and other access control devices for your gate automation system.

“HANDS FREE” ENTRY & EXIT ACCESSORIES

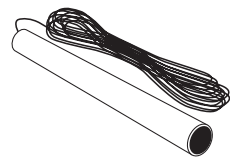

Driveway Vehicle Sensor [FM139]

Automatically activates gate operator “Hands-Free” when a vehicle exits the property. Electromagnetic sensor detects vehicles in motion.

- 50 ft. [FM139]
- 100 ft. [FM140]
- 150 ft. [FM141]
- 250 ft. [FM141-250]

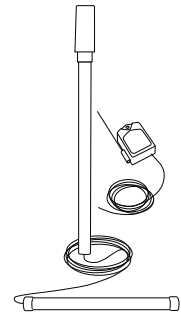

Wireless Vehicle Sensor [R4500]

Automatically activates gate operator “Hands-Free” when a vehicle exits the property. 100 ft. range between transmitter and receiver. Easy installation.

LOCKING & SECURITY ACCESSORIES



Automatic Gate Lock [FM144/FM142]

The #1 Accessory For Swing Gate Operators! Designed for added security in conjunction with GTO Automatic Gate Operators. The gate lock unlocks and locks automatically when the gate opens and closes. The perfect solution for high wind conditions.

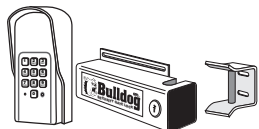

Bulldog Pedestrian Gate Lock [FM145]

Designed to mount on horizontal swing “walk through” wood, chain link, and metal pedestrian gates opening in or out. Ideal for securing pools, condominiums, schools and any pedestrian gate.

Wireless Driveway Alarm [R4450].

This device alerts you of vehicles entering your driveway (with or without an automated gate). The indoor base station signals you with a door chime when a vehicle passes the driveway sensor.

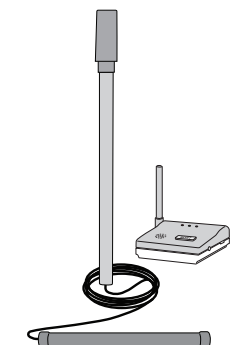

ADDITIONAL ACCESSORIES

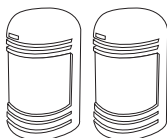
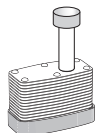

Photo Beams [R4222]

Primary “through beam” photo beam device. Provides “non-contact” entrapment protection.



Pin Lock [FM345]

Use as a substitute for the clevis pin at the front mount of the PRO-SW4000XL to prevent theft of the operator.

- Pin Lock 10-pack: ten Pin Locks keyed alike [FM345KA].



Push Button Control [RB101]

Wire this unlit push button directly to your gate operator for simple open/close/stop operation from up to 1000 ft. away. Use 16 gauge low-voltage wire.

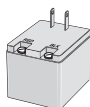

Replacement Transformer [RB570]

Standard 18 volt, 2200 mA AC transformer included with the 4000XLS to maintain battery charge.



Gate Ground Kit [R4196]

The purpose of the grounding kit is to REDUCE THE RISK of damage to electronic equipment from lightning strikes. There is no protection or grounding system that can completely eliminate this risk.

HARDWARE ACCESSORIES

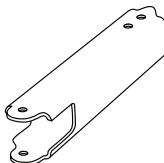

Push To Open Bracket [R4KPTO]

Required when the 4000XLS must push a gate open (arm extends to open), such as away from a sloping driveway or where space prevents gate from opening into the property (pull to open). Order two brackets for a dual swing gate installation.



Column Mount Lock Receiver [433IH]

For use with the Automatic Gate Lock or Bulldog Pedestrian Gate Lock when mounting on brick columns or applications with limited space.

**GTO[®] / ACCESS
SYSTEMS**
PROFESSIONAL RESIDENTIAL

3121 Hartsfield Road • Tallahassee, Florida, USA 32303

(850) 575-0176 • Fax (850) 575-8912

Web site www.gtoaccess.com

24/7 Troubleshooting Wizard: <http://support.gtoinc.com>

