

Installation Manual

for installing the **GTO/PRO SW-4200** with the
GTO/PRO SW-4000 in a dual application



FOR PROFESSIONAL INSTALLATION ONLY!

⚠ WARNING! ⚠

This equipment is similar to other gate or door equipment and meets or exceeds Underwriters Laboratory Standard 325 (UL 325). However, gate equipment has hazards associated with its use and therefore by installing this product the installer and user accept full responsibility for following and noting the installation and safety instructions. Failure to follow installation and safety instructions can result in hazards developing due to improper assembly. You agree to properly install this product and that if you fail to do so GTO, Inc. shall in no event be liable for direct, indirect, incidental, special or consequential damages or loss of profits whether based in contract tort or any other legal theory during the course of the warranty or at any time thereafter. The installer and/or user agree to assume responsibility for all liability and use of this product releasing GTO, Inc. from any and all liability. If you are not in agreement with this disclaimer or do not feel capable of properly following all installation and safety instructions you may return this product for full replacement value.

READ ALL INSTRUCTIONS CAREFULLY AND COMPLETELY before attempting to install and use this automatic gate operator. This gate operator produces a high level of force. Stay clear of the unit while it is operating and exercise caution at all times.

All automatic gate operators are intended for use on vehicular gates only.

This product meets and exceeds the requirements of UL 325, the standard which regulates gate operator safety, as established and made effective March 1, 2000, by Underwriters Laboratories Inc.



3121 Hartsfield Road • Tallahassee, Florida, USA 32303
Telephone GTO Sales: 1-800-543-GATE (4283) or (850) 575-0176 • Fax (850) 575-8912
or GTO Technical Service: 1-800-543-1236 or (850) 575-4144 • Fax (850) 575-8950
www.gtopro.com

R4200 INST
rev - 02/21/06

The GTO/PRO® 4000 Series Gate Operators are intended for use with vehicular swing gates. The operators can be used in Class I, Class II, Class III and Class IV applications.

VEHICULAR GATE OPERATOR CLASS CATEGORIES

Residential Vehicular Gate Operator-Class I: A vehicular gate operator (or system) intended for use in a home of one-to-four single family dwelling, or a garage or parking area associated therewith.

Commercial/General Access Vehicular Gate Operator-Class II: A vehicular gate operator (or system) intended for use in a commercial location or building such as a multifamily housing unit (five or more single family units), hotel, garages, retail store, or other building servicing the general public.

Industrial/Limited Access Vehicular Gate Operator-Class III: A vehicular gate operator (or system) intended for use in an industrial location or building such as a factory or loading dock area or other locations not intended to service the general public.

Restricted Access Vehicular Gate Operator-Class IV: A vehicular gate operator (or system) intended for use in a guarded industrial location or building such as an airport security area or other restricted access locations not servicing the general public, in which unauthorized access is prevented via supervision by security personnel.

Conversion Chart

<i>Converting Metric Units to English Equivalents</i>			
When You Know	Multiply By	To Find	Symbol
centimeters	0.3937	inches	in. (or ")
meters	3.2808	feet	ft. (or')
kilograms	2.2046	pounds	lb. (or #)
<i>Converting English Units to Metric Equivalents</i>			
When You Know	Multiply By	To Find	Symbol
inches	2.5400	centimeters	cm
feet	0.3048	meters	m
pounds	0.4535	kilograms	kg
<i>Converting Temperature</i>			
deg. Celsius	$(^{\circ}\text{C} \times 1.8) + 32$	deg. Fahrenheit	$^{\circ}\text{F}$
deg. Fahrenheit	$(^{\circ}\text{F} - 32) \div 1.8$	deg. Celsius	$^{\circ}\text{C}$

FOR YOUR RECORDS

Please record the product serial number (located on the control box cover), and the date and place of purchase in the spaces provided below. Refer to this information when calling GTO for service or assistance with your automatic gate operator.

Serial Number _____ **Date of Purchase** _____

Place of Purchase _____

Remember to keep all receipts for proof of purchase.

Table of Contents

Gate Operator Class Categories-----	inside cover
Units and Standards Conversion Chart -----	inside cover
PLEASE READ THIS FIRST! -----	page iii
Important Safety Instructions -----	page 1
Disconnecting the Operator -----	page 1
Important Safety Instructions for the Consumer-----	page 2
Secondary Means of Protection Against Entrapment -----	page 5
Required Safety Precautions for Gates-----	page 6
Warning Signs and Labels -----	page 7
Installation -----	page 8
Parts List -----	page 8
Technical Specifications -----	page 11
Installation Overview -----	page 12
Installing the Mounting Hardware-----	page 13
Installing the Post Bracket Assembly -----	page 13
Installing the Gate Bracket -----	page 16
Mounting the Operator -----	page 17
Installation of the Closed Position Stop -----	page 18
Mounting the Control Box-----	page 19
Connecting the Operator Power Cable -----	page 20
Installing the Battery -----	page 20
Powering the System -----	page 22
Solar Chart-----	page 22
Connecting the Transformer-----	page 23
Control Board Settings -----	page 25
DIP Switches -----	page 25
Setting the Closed Position -----	page 27
Setting Your Personal Transmitter Code -----	page 28
Obstruction Sensitivity -----	page 29
Installing the Receiver -----	page 29
Connecting Additional Safety Devices -----	page 30
Connecting Accessories -----	page 32
Push to Open Installation -----	page 33
Maintenance & Troubleshooting Guide -----	page 34
Repair Service -----	page 38
Column Installation Information -----	page 39
Accessory Catalog -----	page 40

KEEP THESE INSTRUCTIONS FOR FUTURE REFERENCE



PLEASE READ THIS FIRST!

Thank you for purchasing a **GTO/PRO® 4000/4200**. When correctly installed and properly used, your **GTO/PRO® 4000/4200 Operators** will give you many years of reliable service. Please read the following information to ensure you have the correct system for your particular needs. This manual will enable you to properly install your **GTO/PRO® 4000/4200 Automatic Gate Operators**.

The **GTO/PRO® 4000/4200 Operators** are designed for installation on **pull-to-open and push-to-open leaf gates**. The gates must not exceed 20 feet in length (per leaf) nor weigh more than 1000 pounds (per leaf) (please see *Technical Specifications* on page 10). The **GTO/PRO® 4000/4200 Operators** can be used on vinyl, aluminum, chain link, farm tube, and wrought iron gates. Use on solid (wood) gates is not recommended. Solid surface gates have a high resistance to the wind. If the wind is strong enough, the operator will obstruct and stop.

The **GTO/PRO® 4000/4200 Operators** accommodate extra transmitters, digital keypads, solar panels, push buttons, automatic gate locks, and other access control products. These optional accessories (see the *Accessory Catalog*) are available.

The **GTO/PRO® 4000/4200 Operators** feature **adjustable obstruction sensing**. This safety feature makes the gates stop and reverse direction within 2 seconds if they come in contact with an obstruction. **MIN** is the factory setting; meaning the gates will exert the minimum force on an obstruction before they stop and reverse direction.

The **GTO/PRO® 4000/4200 Operators** also have an **adjustable auto-close feature**. After the gates reaches the fully open position, they can be set to remain open up to 120 seconds before automatically closing. Pressing the transmitter button at any time after the gates open fully will cause them to close immediately. **OFF** is the factory setting; meaning the gates will stay open until you press the transmitter (or keypad, etc.) again.

Please call GTO at **(800) 543-GATE [4283]** or **(850) 575-0176** for more information about our **GTO/PRO®** professional line of gate operators and accessories. Our Sales Department will be glad to give you the name and phone number of a **GTO/PRO®** dealer near you.

BEFORE YOU BEGIN TO INSTALL YOUR AUTOMATIC GATE OPERATOR:
Read these instructions *carefully and completely* to become familiar with all parts and installation steps.
You must read the installation manual for detailed instructions on gate operator safety and proper use of the gate operator.



IMPORTANT SAFETY INSTRUCTIONS



Because automatic gate operators produce high levels of force, consumers need to know the potential hazards associated with improperly designed, installed, and maintained automated gate operator systems. **Keep in mind that the gate operator is just one component of the total gate operating system.** Each component must work in unison to provide the consumer with convenience, security, and safety.

This manual contains various safety precautions and warnings for the consumer. Because there are many possible applications of the gate operator, the safety precautions and warnings contained in this manual cannot be completely exhaustive in nature. They do, however, provide an overview of the safe design, installation, and use of this product. **CAREFULLY READ AND FOLLOW ALL SAFETY PRECAUTIONS, WARNINGS, AND INSTALLATION INSTRUCTIONS TO ENSURE THE SAFE SYSTEM DESIGN, INSTALLATION, AND USE OF THIS PRODUCT.**

Precautions and warnings in this manual are identified with this  warning symbol. The symbol identifies conditions that can result in damage to the operator or its components, serious injury, or death.

Because GTO automatic gate operators are *only part* of the total gate operating system, it is the responsibility of the consumer to ensure that the total system is safe for its intended use.

To Manually Open and Close the Gate, Follow the Procedure Below:

 **CAUTION:** The gate will move freely and uncontrolled when the gate operator is removed from the gate. **ONLY** disconnect the operator when the control box power switch is **OFF** and the gate is **NOT** moving.

Disconnecting the Operator

1. Turn control box power switch **OFF**.
2. Remove hairpin clip, clevis pin, and bushing from either the front or rear mounting point.
3. Remove the opener from the mount.

The gate can be opened and closed manually when the operator is disconnected.

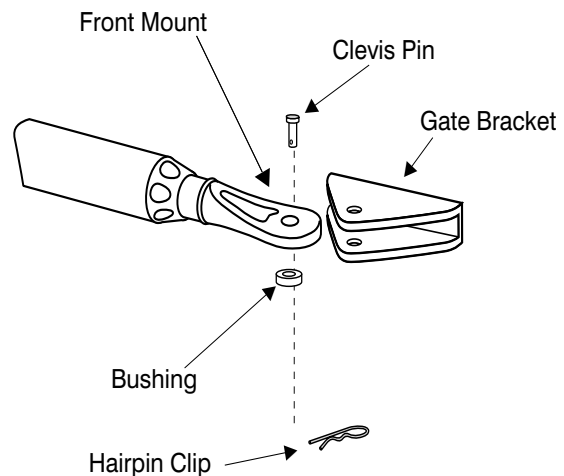

NOTE: Substitute a **Pin Lock** for the clevis pin on the front mount of the gate operator to prevent unauthorized removal of the operator from the gate (see *Accessory Catalog*).

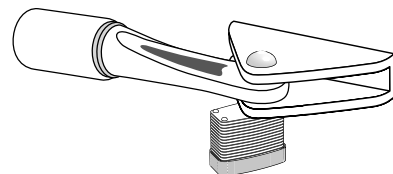



IMPORTANT SAFETY INSTRUCTIONS



For The Consumer

WARNING: To reduce the risk of injury or death:

1. **READ AND FOLLOW ALL INSTRUCTIONS.** Failure to meet the requirements set forth in the instruction manual could cause severe injury and/or death, for which the manufacturer cannot be held responsible.
2. When designing a system that will be entered from a highway or main thoroughfare, make sure the system is placed far enough from the road to prevent traffic congestion.
3. The gate must be installed in a location that provides adequate clearance between it and adjacent structures when opening and closing to reduce the risk of entrapment. Swinging gates **must not** open into public access areas.
4. The gate and gate operator installation **must comply with any applicable local codes.**

I. Before Installation

1. Verify this operator is proper for the type and size of gate, its frequency of use and the proper class rating.
2. Make sure the gate has been properly installed and swings freely in both directions. Repair or replace all worn or damaged gate hardware prior to installation. A freely moving gate will require less force to operate and will enhance the performance of the operator and safety devices used with the system.
3. Review the operation of the system to become familiar with its safety features. Understand how to disconnect the operator for manual gate operation (*see page 1*).
4. This gate operator is intended for **vehicular gates ONLY**. A separate entrance or gate must be installed for pedestrian use (*see page 6*).
5. Always keep people and objects away from the gate and its area of travel. **NO ONE SHOULD CROSS THE PATH OF A MOVING GATE.**
6. Pay close attention to the diagram below and be aware of these areas at all times.

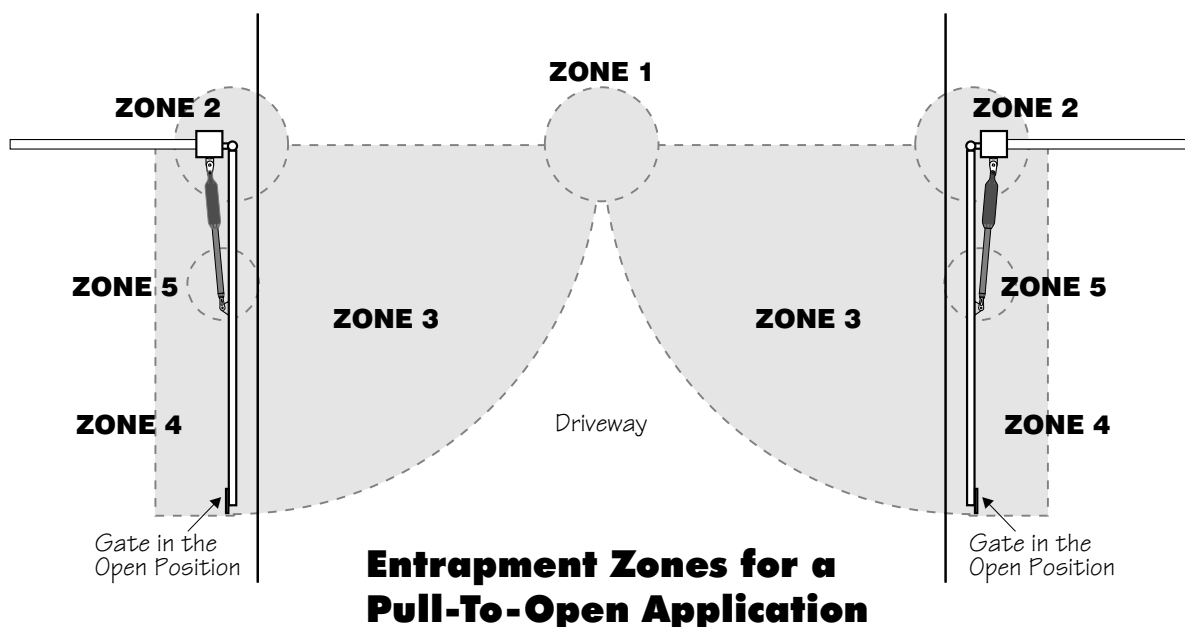



IMPORTANT SAFETY INSTRUCTIONS



Entrapment Zones for a proper Pull-To-Open installation:

- Zone 1 – leading edge of the gate and the fence post.
- Zone 2 – between the gate and the gate post.
- Zone 3 – the path of the gate.
- Zone 4 – the space between the gate in the open position and any object such as a wall, fence, tree, etc.
- Zone 5 – pinch points between the opener and gate or post.

II. During Installation

1. Install the gate opener on the inside of the property and fence line. **DO NOT** install an opener on the outside of the gate where the public has access to it.
2. Be careful with moving parts and avoid close proximity to areas where fingers or hands could be pinched.
3. Devices such as contact sensors (safety edges) and non contact sensors (photo beams) provide additional protection against entrapment.
4. If push buttons or key switches are installed, they should be within sight of the gate, yet located at least 10 feet from any moving part of the gate (see diagram below). *Never install any control device where a user will be tempted to reach through the gate to activate the gate opener.*
5. Do not activate your gate opener unless you can see it and can determine that its area of travel is clear of people, pets, or other obstructions. Watch the gate through its entire movement.
6. Secure outdoor or easily accessed gate opener controls in order to prohibit unauthorized use of the gate.

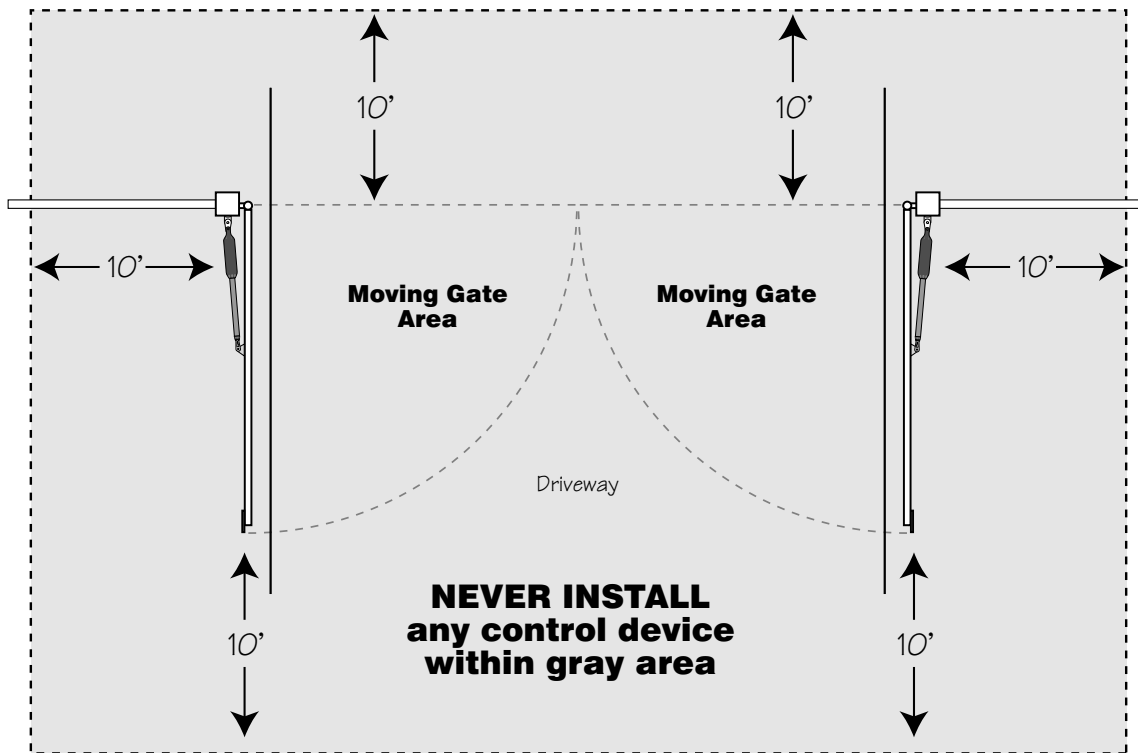

Pull-To-Open Application



IMPORTANT SAFETY INSTRUCTIONS



III. After Installation

1. Attach the **warning signs** (*included*) to each side of the gate to alert the public of automatic gate operation. It is *your responsibility* to post warning signs on both sides of your gate. If any of these signs or warning decals become damaged, illegible or missing, replace them immediately. Contact GTO for free replacements.
2. The gate is automatic and could move at any time, posing a serious risk of entrapment. No one should be in contact with the gate when it is moving or stationary.
3. Do not attempt to drive into the gate area while the gate is moving; wait until the gate comes to a complete stop.
4. Do not attempt to "beat the gate" while the gate is closing. This is extremely dangerous.
5. Do not allow children or pets near your gate. **Never let children operate or play with gate controls.** Keep the remote controls away from children and unauthorized users; store controls where children and unauthorized users do not have access to them.
6. **KEEP GATES PROPERLY MAINTAINED.** Always turn power to operator OFF before performing any maintenance. Clean the push-pull tube with a soft, dry cloth and apply silicone spray to it at least once per month.
7. Service the gate and gate operator regularly. Grease hinges, spray push pull tube with high quality silicon spray and replace the battery every 3-5 years.
8. To operate this equipment safely, YOU must know how to disconnect the operator for manual gate operation (*see page 1*). If you have read the instructions and still do not understand how to disconnect the operator, contact the GTO Service Department.
9. Disconnect the operator **ONLY** when the power is **TURNED OFF** and the gate is **NOT** moving.
10. Make arrangements with local fire and law enforcement for emergency access.
11. Distribute and discuss copies of the **IMPORTANT SAFETY INSTRUCTIONS** section of this manual with all persons authorized to use your gate.
12. **IMPORTANT: Save these safety instructions. Make sure everyone who is using or will be around the gate and gate operator are aware of the dangers associated with automated gates. In the event you sell the property with the gate operator or sell the gate operator, provide a copy of these safety instructions to the new owner.**

Should you lose or misplace this manual, a copy can be obtained by downloading one from the GTO/PRO® web site (www.gtopro.com), by contacting GTO, Inc., at 3121 Hartsfield Road, Tallahassee, Florida 32303 or by calling 1-800-543-4283 and requesting a duplicate copy. One will be provided to you free of charge.



IMPORTANT SAFETY INSTRUCTIONS



Secondary Means of Protection Against Entrapment

As specified by Gate Operator Safety Standard, UL 325 (30A.1.1), automatic gate operators shall have an inherent entrapment sensing system, and shall have *provisions for, or be supplied with*, at least one independent secondary means to protect against entrapment. The GTO/PRO® 4000/4200 utilizes **Type A**, an inherent (i.e., built-in) entrapment sensing system as the **primary** type of entrapment protection. Also, the GTO/PRO® 4000/4200 has *provisions for* the connection of **Type B2** protection to be used as the **secondary** type of entrapment protection, if desired.

1. For gate operators utilizing a contact sensor (e.g., safety edge sensor– Type B2) in accordance with UL 325 (51.8.4 [i]):
 - A. One or more contact sensors shall be located at the leading edge, bottom edge, and post edge, both inside and outside of a vehicular swing gate system.
 - B. A hard wired contact sensor shall be located and its wiring arranged so that the communication between the sensor and the gate operator is not subjected to mechanical damage.
 - C. A wireless contact sensor such as one that transmits radio frequency (RF) signals to the gate operator for entrapment protection functions shall be located where the transmission of the signals are not obstructed or impeded by building structures, natural landscaping or similar obstruction. A wireless contact sensor shall function under the intended end-use conditions.

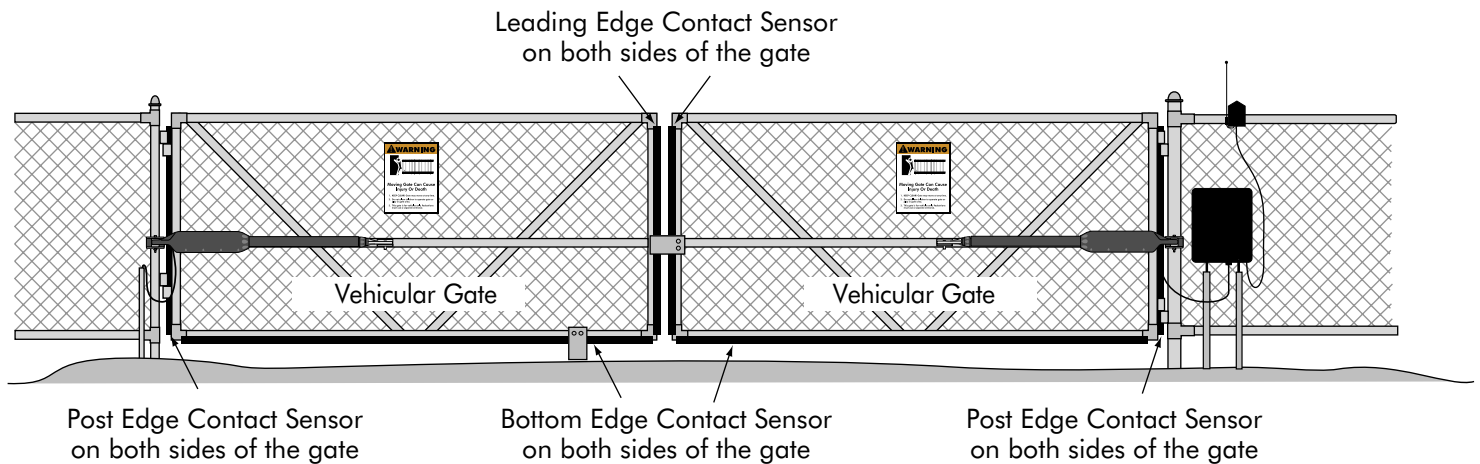

ENTRAPMENT ALARM (UL 325; 30A.1.1A)

The GTO/PRO® 4000/4200 Automatic Gate Operators are designed to stop and reverse within 2 seconds when the gate comes in contact with an obstruction. Additionally, these operators are equipped with an **audio entrapment alarm** which will activate if the unit obstructs *twice* while opening or closing. This alarm will sound for a period of 5 minutes, or until the operator receives an intended signal from a hardwired entry/exit source (e.g. push button control or keypad) and the gate returns to a fully open or fully closed position. Turning the power switch on the control box OFF and back ON will also deactivate the alarm. Wireless controls such as transmitters and wireless keypads will not deactivate the alarm.



IMPORTANT SAFETY INSTRUCTIONS



Required Safety Precautions for Gates Install Warning Signs

Warning signs alert people of automatic gate operation and are **required** when installing the GTO/PRO® 4000/4200 Automatic Gate Operators. Furthermore, a walk-through gate must be installed if pedestrian traffic is expected near the vehicular gate. We recommend using the **GTO Bulldog Pedestrian Gate Lock** (Call the GTO Sales Department) for controlled access.

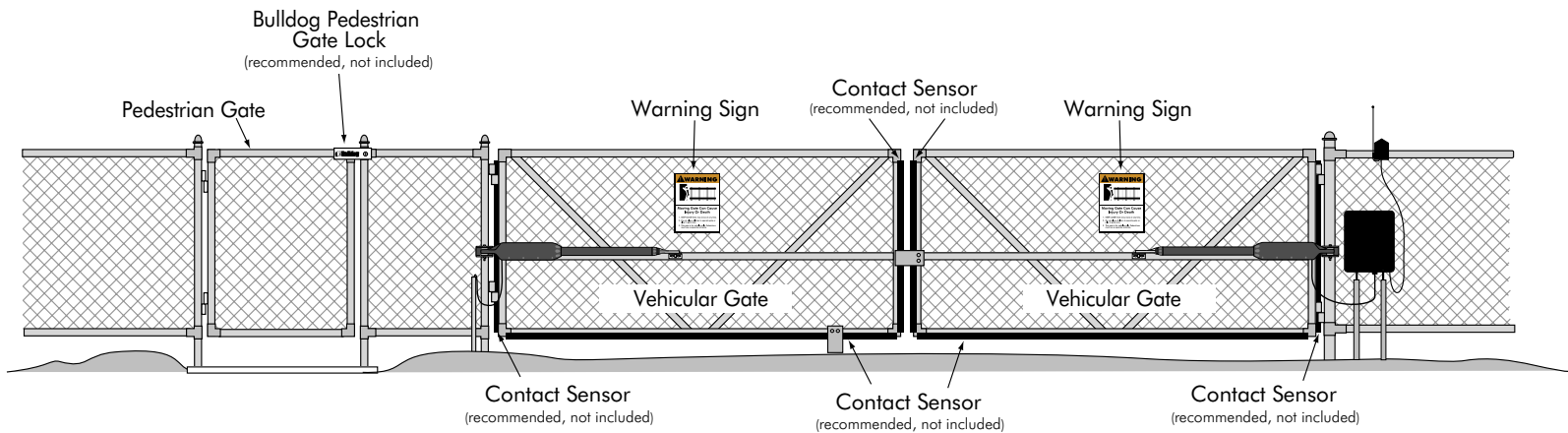

Entrapment Protection

GTO's inherent obstruction settings, even when properly adjusted, *may not be sensitive enough to prevent bodily injury in some circumstances*. For this reason, safety devices such as safety edge sensors (or photoelectric sensors), which stop and reverse gate direction upon sensing an obstruction, are suggested for enhanced protection against entrapment.

Warning Signs

The warning signs (*at right*) must be installed on both sides of the gate (*see page 7 for details*).





IMPORTANT SAFETY INSTRUCTIONS



! WARNING



Moving Gate Can Cause Injury Or Death

- 1. KEEP CLEAR! Gate may move at any time.**
- 2. Do not allow children to operate gate or play in gate area.**
- 3. This gate is for vehicles only. Pedestrians must use a separate entrance.**

These warning labels should be found at the locations specified below. If any of them are missing, immediately contact GTO for replacements.

ETV LISTED us #XXXXXXX

GTO DC SW-4000 SERIES
 Conforms to UL 325 STANDARDS
 Maximum Gate: 1000 lb. (453.5 kg); 20 ft. (6.1 m)
 Voltage: 12 Vdc; Frequency: 0 Hz; Power: 60 W
 Class I, II, III and IV Vehicular Swing Gate Operator.
 Serial Number: XXXXXXXXX

TO MANUALLY OPEN AND CLOSE THE GATE:

1. Turn control box power switch OFF.
2. Disconnect front or rear mount from gate bracket.
3. Pull operator away from front or rear mounts.

Disconnect operator **ONLY** when the control box power switch is **OFF** and the gate is **NOT** moving.

GTO, Inc. Tallahassee, Florida USA

Warning signs (4 enclosed) to be installed on each side of the gate (3-5 feet above the bottom of the gate).

Product identification and manual operation instruction label (1) installed on control box.



! WARNING

MOVING GATE Can Cause Injury or Death

1. KEEP CLEAR! Gate may move at any time.
2. Do not allow children to operate gate or play in gate area.
3. This gate is for vehicles only. Pedestrians must use separate entrance.

Logo and warning labels (2) installed on each side of master operator housing.



! WARNING

MOVING GATE Can Cause Injury or Death

1. KEEP CLEAR! Gate may move at any time.
2. Do not allow children to operate gate or play in gate area.
3. This gate is for vehicles only. Pedestrians must use separate entrance.

Logo and warning labels (2) installed on each side of slave operator housing.

SW-4000 Parts List

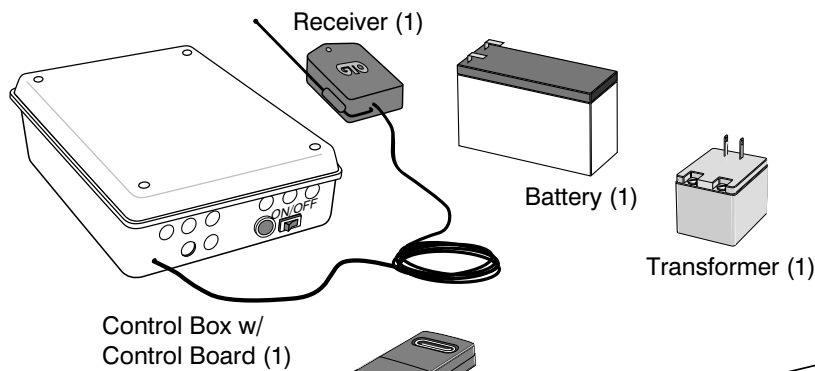

Warning Signs (2)

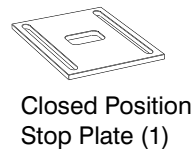
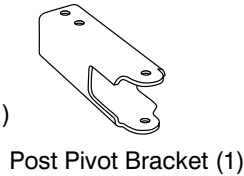
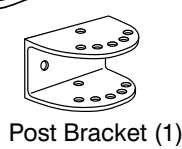
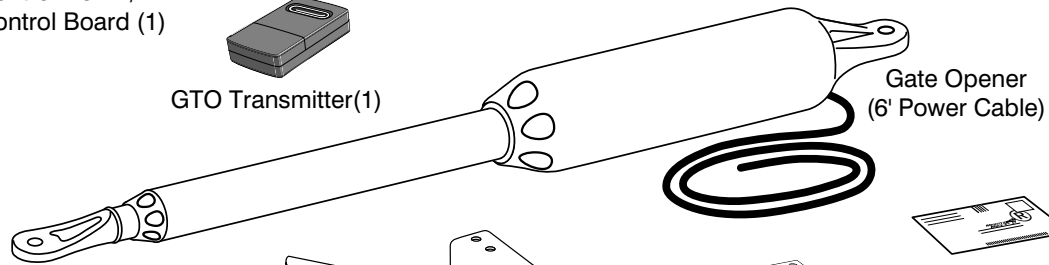

Hardware

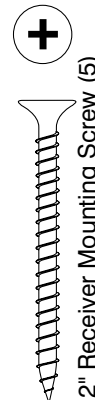
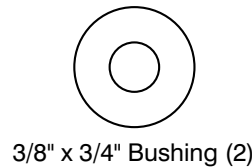
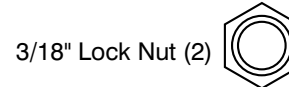
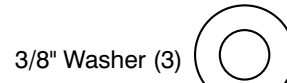
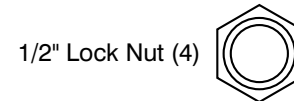
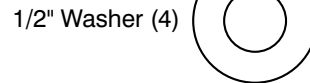
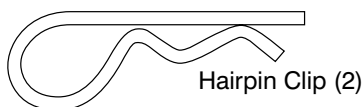
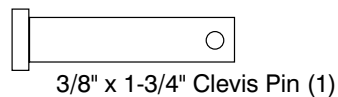
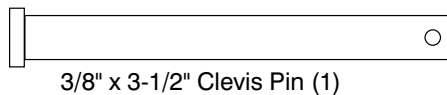
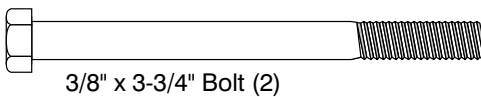
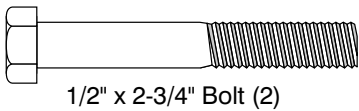
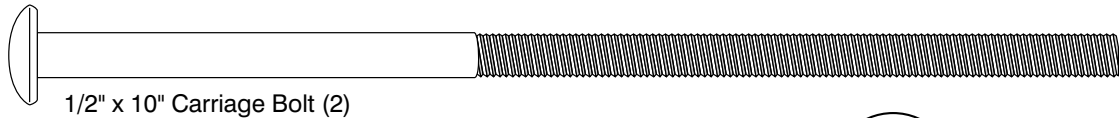

SW-4200 Parts List



Warning Signs (2)

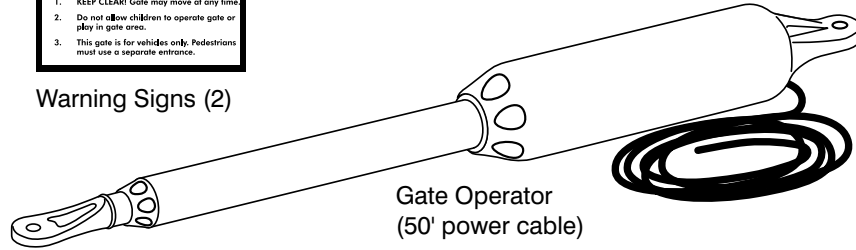

Gate Operator
(50' power cable)

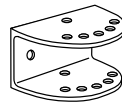

Post Bracket (1)



Gate Bracket (1)

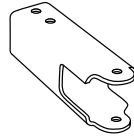

Post Pivot Bracket (1)

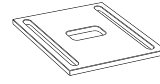

Closed Position
Stop Plates (1)

8" Nylon Cable Tie (10)

Hardware

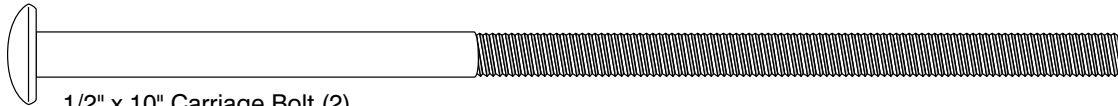

1/2" x 10" Carriage Bolt (2)



1/2" x 2-3/4" Bolt (2)

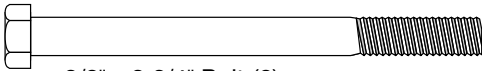

3/8" x 3-3/4" Bolt (2)

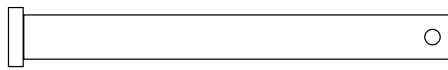

3/8" x 3-1/2" Clevis Pin (1)

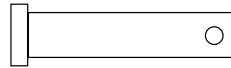

3/8" x 1-3/4" Clevis Pin (1)

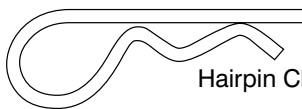

Hairpin Clip (2)

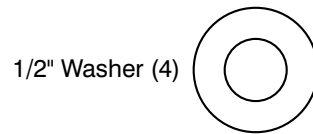

1/2" Washer (4)

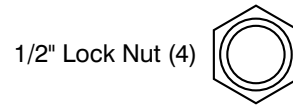

1/2" Lock Nut (4)

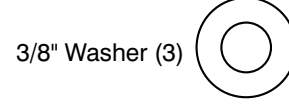

3/8" Washer (3)

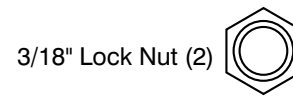

3/18" Lock Nut (2)

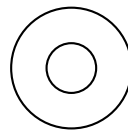

3/8" x 3/4" Bushing (2)

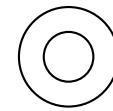

3/8" x 3/16" Bushing (2)

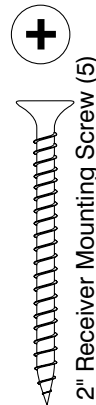

2" Receiver Mounting Screw (5)

Other Materials You May Need Before You Start the Installation:

Depending on the type of gate and fence post, you may need some additional materials/hardware. Some of these items can be found in the *GTO/PRO Accessory Catalog*.

- Low voltage wire may be needed. Length depends upon the distance between the transformer power supply and the control box. See page 22, **Powering the System** and the *Accessory Catalog* for wire and solar charging panels.
- If the gate is more than 1000' away from an AC power source you will need to use at least one GTO Solar Panel to trickle charge the battery. See the *Accessory Catalog*.
- The diameter of the fence post should be at least 8" (round) or 6" (square) in order to mount the post bracket (see page 13).
- Depending upon the diameter of the fence post, you may need longer carriage bolts than those provided. Bolts should be at least 1" longer than the diameter of the fence post (see page 13).
- A horizontal or vertical cross member or mounting plate may be needed to mount the operator to the gate. See page 12.

Tools Needed

- Power Drill
- Open End Wrenches — $\frac{3}{8}$ ", $\frac{7}{16}$ ", $\frac{1}{2}$ ", and $\frac{9}{16}$ "
- $\frac{3}{8}$ " Drill Bit
- Hacksaw or Heavy Duty Bolt Cutters
- Small (Flat Bladed) Screwdriver
- Phillips Screwdriver
- Tape Measure
- Level
- Wire Strippers
- C-Clamps — small, medium, and large
- Center Punch
- Extra person will be helpful

Technical Specifications

GTO/PRO® 4000/4200 AUTOMATIC GATE OPERATOR

DRIVE

- Low friction screw drive (linear actuator) rated for -5 °F to +160 °F (-28 °C to +71 °C). Use of heater bans on arm and control box will enhance performance in extreme cold temperatures.
- Powered by a 12 V motor with integral case hardened steel gear reducer. Motor speed reduced to 260 rpm. Generates 820 ft.. lb. of torque at 12 V.
- Maximum opening arc of 110°. Approximate opening time (90°): 20 seconds, depending on weight of gate.

POWER

- The system is powered by a 12 Vdc, 7.0 Ah, sealed, rechargeable acid battery.
- Battery charge is maintained by a 120 Vac, 18 Vac output transformer rectified to 14.5 Vdc (40 VA) through the GTO control board. Blade-style control board fuse is rated for 25 A.

NOTE: The transformer should not be directly connected to any battery. Do not replace fuses with higher ampere rated fuses; doing so will void your warranty and may damage your control board.

- Battery charge is maintained by GTO Solar Panel Charger: float voltage of 14.5 Vdc output from a 19³/₈" x 8¹/₂" silicon alloy panel. Generates minimum of 5 W at 300 mA. A gated diode on the control board prevents battery discharge.

CONTROL

- GTO microprocessor-based control board is set for single leaf, pull-to-open gate installations. DIP switches can be adjusted to accommodate an optional kit for push-to-open gates (*see Accessory Catalog*).
- Control board has temperature compensated circuits.
- A circuit on the control board regulates charging. "Sleep draw" is 40 mA; "active draw" is 5 to 9 A.
- Auto-memorization of digital transmitter code.
- GTO remote-mounted RF receiver tuned to 318 MHz.
- Operator length with push-pull tube fully retracted is 46¹/₄", mounting point to mounting point.
- Adjustable auto-close timer (15 to 120 s), and obstruction sensitivity.
- Power terminal block accommodates a transformer and solar panels.
- DIP switches simplify setup of gate operator.
- Accessory terminal block fully compatible with push button controls, digital keypads, safety loops, etc.
- Control board allows connection of safety edge sensors and photoelectric sensors.
- Audio entrapment alarm sounds if unit encounters an obstruction twice while opening or closing.

OPERATIONAL CAPACITY

- The Gate Capacity Chart shows approximate cycles, per day, you can expect from the GTO/PRO® 4000/4200 Automatic Gate Operators when powered with a transformer. Actual cycles may vary slightly depending upon the type and condition of gate and installation.

Gate Capacity Chart GTO/PRO 4200									
<i>Estimated number of cycles are based on use with a transformer and one(1) 12 Volt battery on a dual gate system.</i>									
Gate Length	20 ft.	67	65	62	60	57	55	52	50
	16 ft.	70	67	65	62	60	57	55	52
	12 ft.	72	70	67	65	62	60	57	55
	8 ft.	75	72	70	67	65	62	60	57
		300 lb.	400 lb.	500 lb.	600 lb.	700 lb.	800 lb.	900 lb.	1000 lb.
Gate Weight									

NOTE: BALL BEARING HINGES SHOULD BE USED ON ALL GATES WEIGHING OVER 250 LB.

To determine the number of cycles the gate operator will perform using solar panels, please see the specifications listed on *page 21* or call (800) 543-1236 or (850) 575-4144 for more information.

* An operation cycle is one full opening and closing of the gate.

These specifications are subject to change without notice.

Installation Overview

Pull-to-Open Gates (Gates Open into the Property)

The diagram shown below is an example of a pull-to-open installation on a chain link fence and single gate. Mounting the operators on a masonry columns require special procedures; see **Column Installation Information** on page 38 if you intend to mount the operator on a column. Furthermore, if you have a push-to-open gates, you will need to purchase two **push-to-open brackets** (see *Accessory Catalog*) to properly configure your system. See **Push to Open Installation** on page 33 before proceeding.

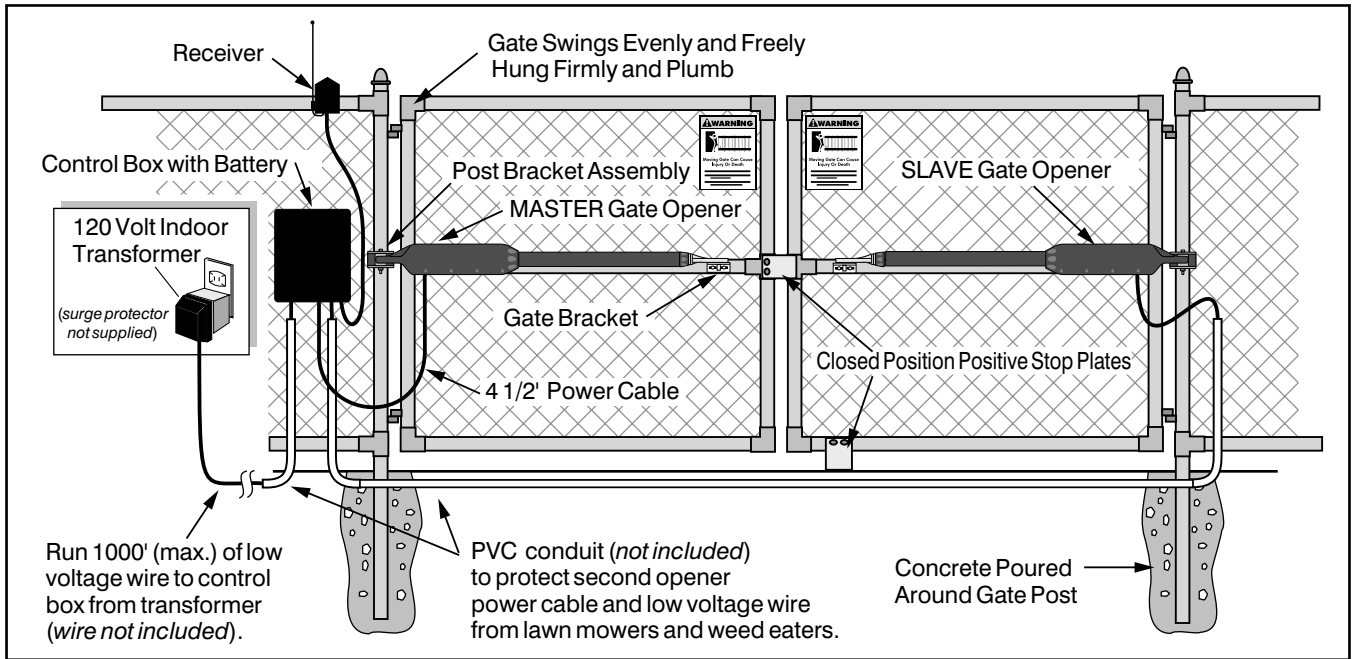

Preparation of the Gate

Step 1

The gates **must** be plumb, level, and swing freely on hinges. Wheels must not be attached to the gates. The gates must move throughout the arc **without binding or dragging on the ground**. Note that gates over 250 lb. should have ball bearing hinges with grease fittings.

Step 2

The fence posts must be secured in the ground with concrete to minimize twist or flex when the operators are activated. We recommend you position the operators near the **centerline** of the gates to keep them from twisting and flexing. The addition of **horizontal or vertical cross members** (if one is not already in place) to provide a stable area for mounting the gate brackets also important.

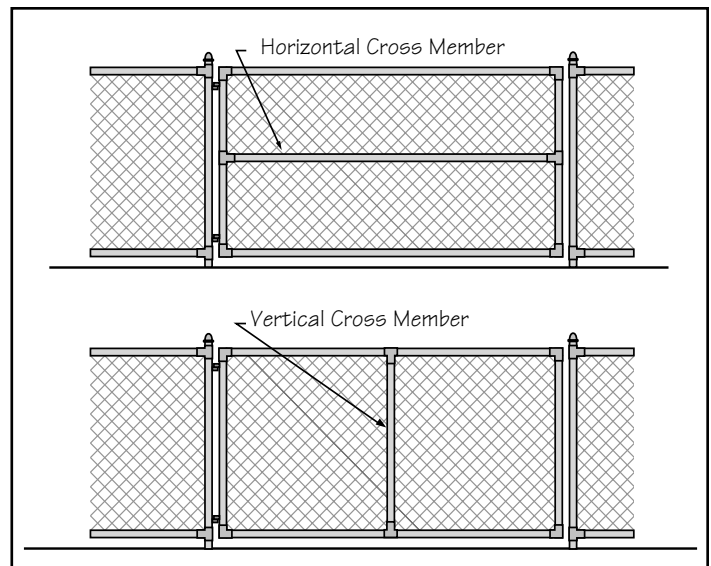

Installing Mounting Hardware

Installing the Post Bracket Assembly

The post bracket is designed to work on a *flat* fence post. Fence posts must be at least 6" square in order to mount the post bracket.

NOTE: The best method of attaching the post bracket to metal post is welding. Round wood posts (no smaller than 8" diameter) may be notched to create a flat surface for attaching the post bracket.

If bolts are used to mount the post bracket, the bolts must *completely* penetrate the fence post. If your fence post is wider than 8", it will be necessary to use carriage bolts longer than those supplied. On **wood** posts use a metal plate (not provided) between the nuts and post to prevent the operator from pulling the bolts and washers through the wood.

On masonry columns use red heads or other secure masonry mounting hardware.

NOTE: A fence post smaller than 6" in diameter or 6" square should be made of metal instead of wood so that it will remain stable while the operator is moving the gate.

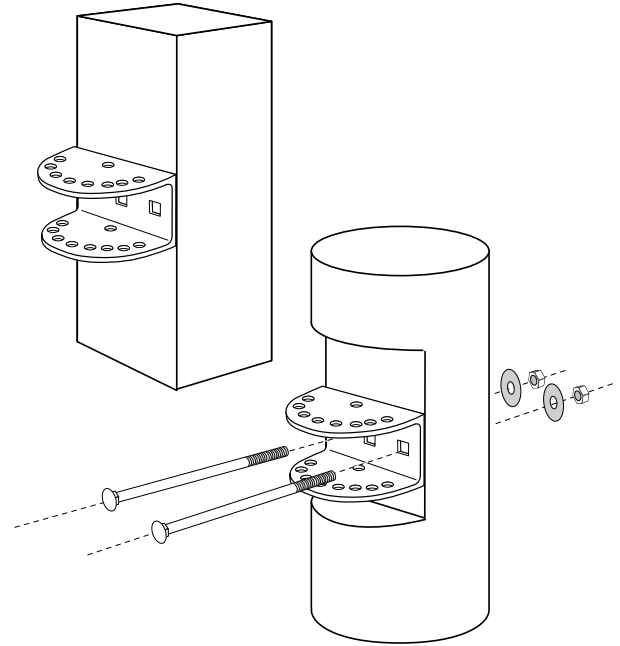

Step 1:

Close the gate and place your level against the horizontal cross member. The top of the level should be in the center of the cross member and should overlap the fence post. Scribe a line across the cross member and fence post. You will use this line to help determine position of gate and post brackets.

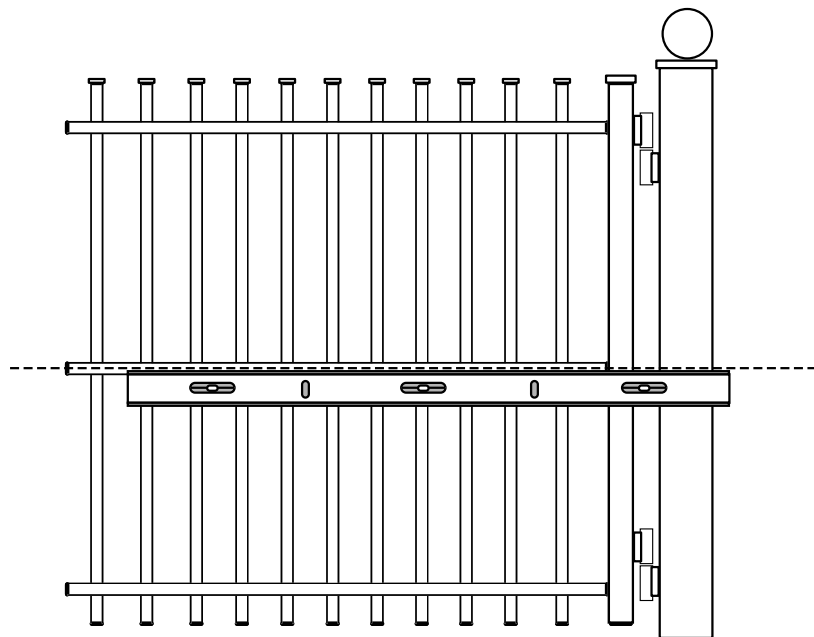

Step 2:

Position the post bracket on the fence post with the mounting holes centered over the scribe line. The post bracket should be flush with the edge of the fence post closest to the gate (see illustration). Mark the position of post bracket holes on the fence post.

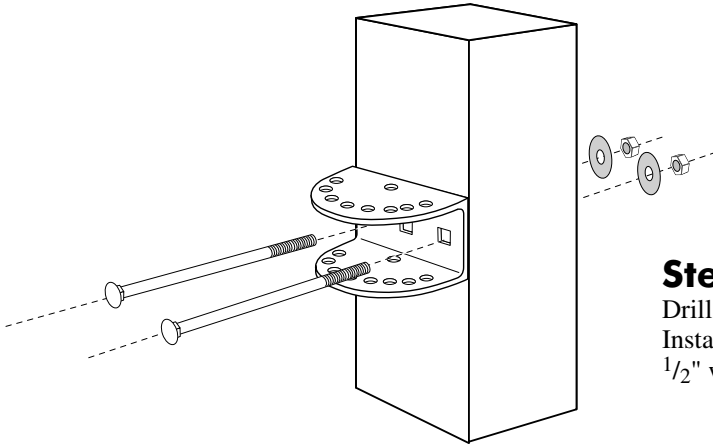
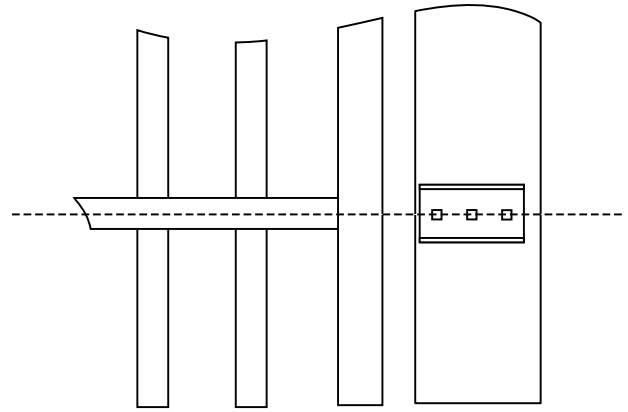

Step 3:

Drill holes in fence post as marked using a 1/2" drill bit. Install the post bracket using the 1/2" x 10" carriage bolts, 1/2" washers, and lock nuts (provided).

Step 4:

Place the end of post pivot bracket with two holes inside the post bracket. Align the back hole in the post pivot bracket with back hole in the post bracket. Insert 1/2" x 3 3/4" hex head bolt through post pivot bracket and post bracket and secure with washer, large bushing, lockwasher and nut.

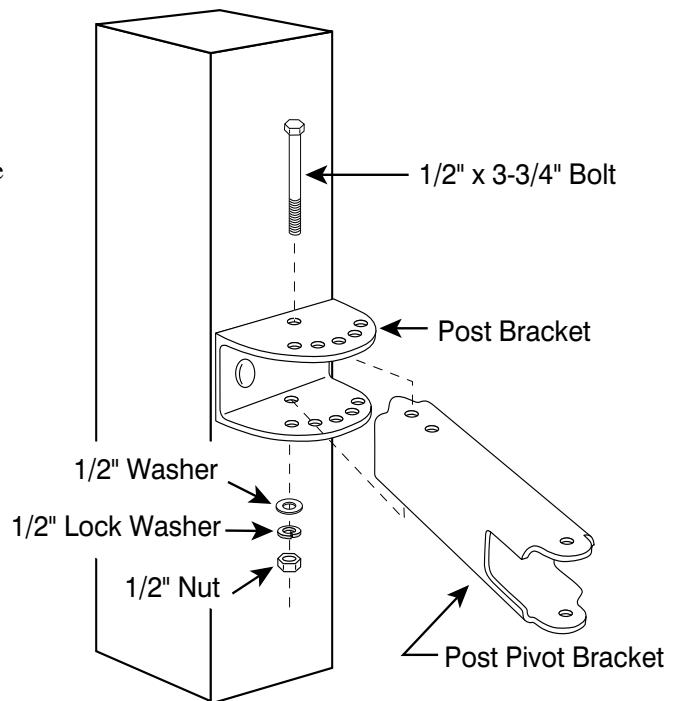

Step 5:

Position the operator rear mount between post pivot bracket. Place a small bushing under the rear mount. Align the hole in rear mount, bushing and post pivot brackets and secure with the clevis pin and hair pin clip.

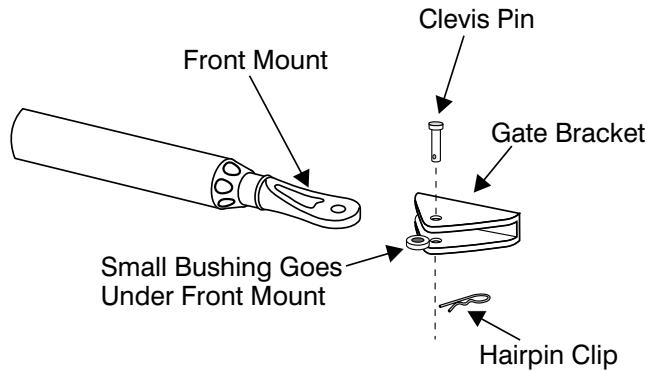
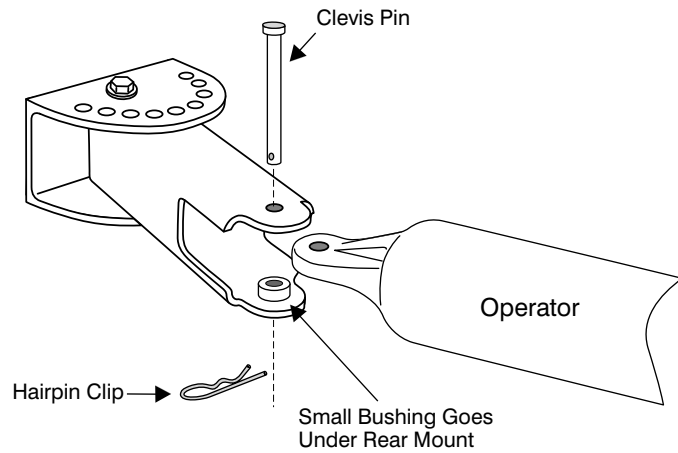

Step 6:

Place a small bushing under the the front mount and attach the gate bracket to the front mount using the clevis pin and hairpin clip.

Step 7:

Open the gate to the desired open position. Position the operator so that the gate bracket rests against the gate along the level scribed line. Check the clearance between the operator and the gate. The operator should only make contact with the gate at the gate bracket. See illustration at right for examples of clearance.

When you feel that you have the best position for the post pivot bracket in the open position, insert the bolt through the aligned holes of the post bracket and post pivot bracket to hold it in place.

Clamp the gate bracket to the gate using c-clamps or another type of clamp.

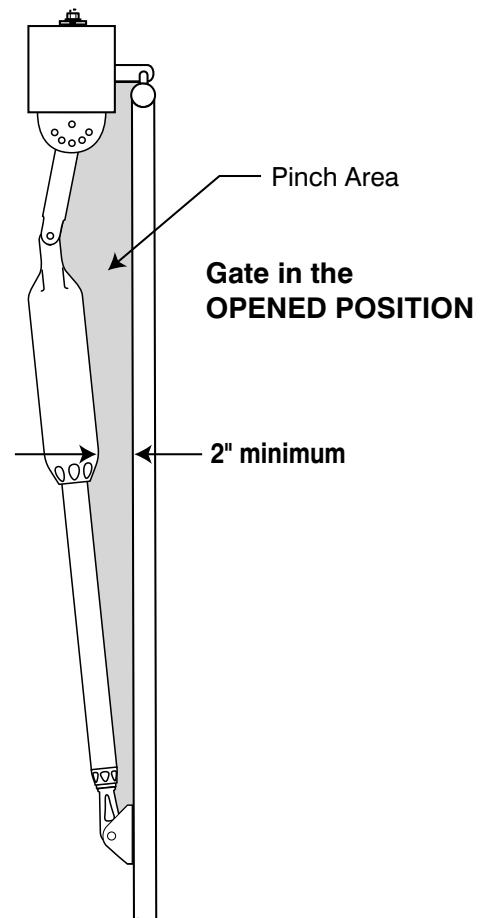

IMPORTANT: While determining the position of the post pivot bracket, be sure that the position allows for minimum 2 inches of clearance between the gate and the operator in both the open and closed positions, as shown in Steps 7 & 8 . This clearance will give the operator the most efficient leverage point for opening and closing the gate and more importantly provides the least possible pinch area.

Step 8:

Remove the clevis pin from the front mount and while supporting the gate operator, swing the gate and gate operator to the closed position. With the gate and gate operator in the closed position check the clearance and be sure that the gate operator is not binding at the post pivot bracket.

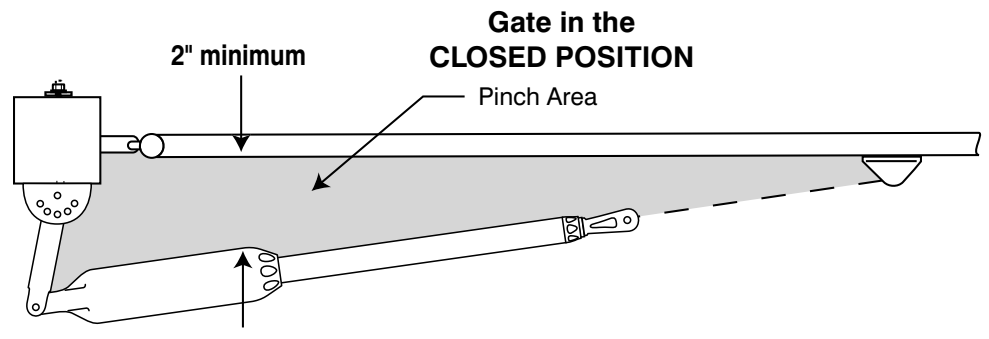

If you don't have 2 inches of clearance or the gate operator is binding on the post pivot bracket, remove the bolt in the post bracket and readjust the pivot bracket until you can achieve the proper clearance.

With the post pivot bracket in the optimum position for clearance and freedom of movement, replace the bolt in a post bracket adjustment hole and return the operator to the open position and recheck the gate operator level and clearance. Make sure the gate bracket is clamped securely.

Installing the Gate Bracket

Step 9:

Move the operator away from the gate bracket. The mounting holes should be centered over the scribe line. Mark the gate in the center of the gate bracket holes. Remove the gate bracket and drill the 1/2" holes in the gate cross member and attach the gate bracket using the 1/2" x 2 3/4" bolts, washers and nuts.

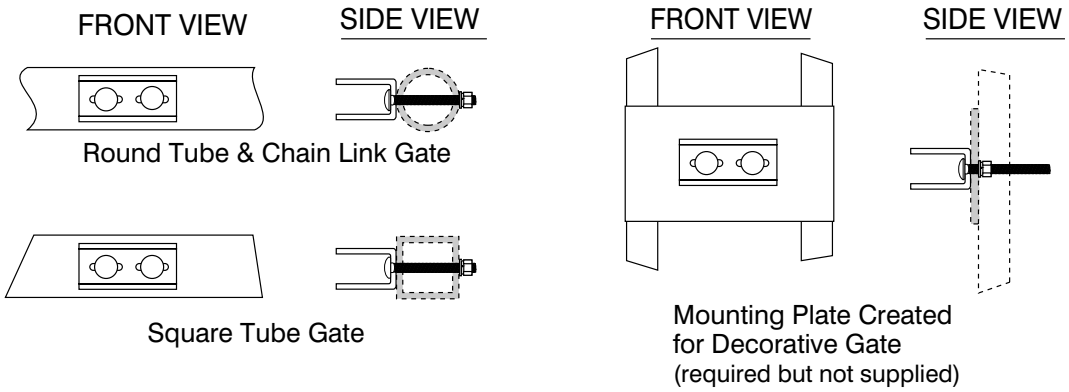
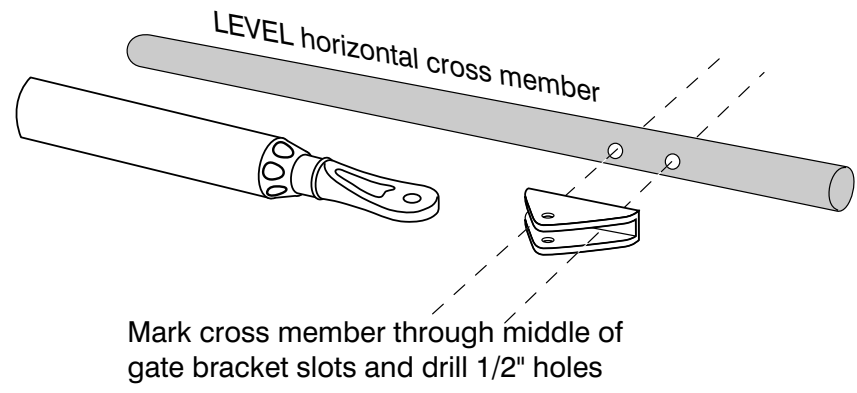

Mounting the Operator

Step 10

Attach the operator to the securely bolted post bracket assembly and gate bracket using clevis pins, bushings, and hairpin clips, or optional Pin Locks (see *Accessory Catalog*). Verify that the operator is level and adjust the post bracket assembly if necessary.

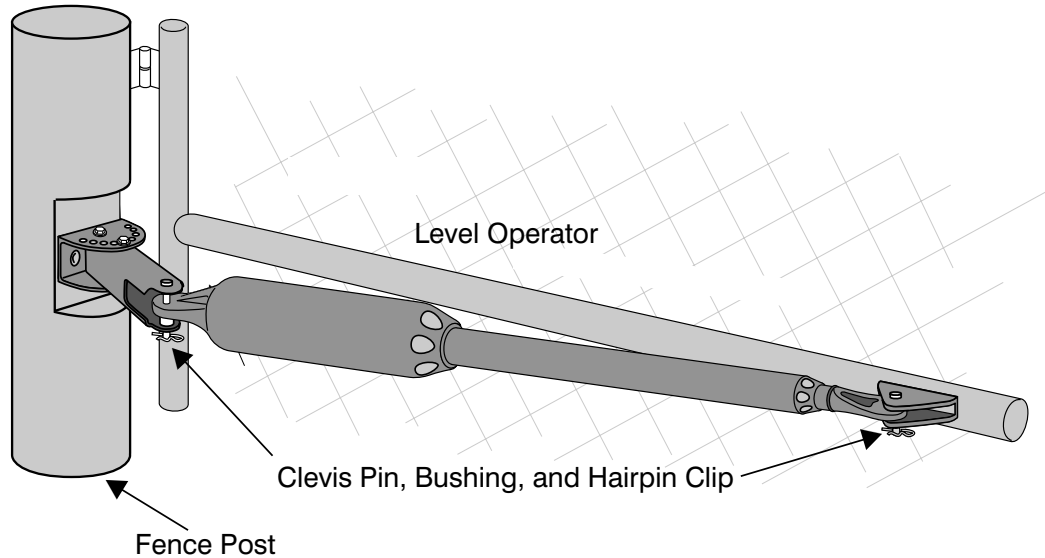

DUAL GATE INSTALLATION

You will need to install the GTO/PRO 4200 SLAVE operator arm on the second gate following the same steps you did to install the GTO/PRO 4000 MASTER operator arm. Beginning on page 13, Step 1 through page 17, Step 10. When the second gate operator is installed go to the page 18 and continue.

Installation of the Closed Position Stops

The GTO/PRO® 4000/4200 Gate Operators firmly hold the gates in the closed position using positive stops. The positive stops help stabilize the gate leaves in the closed position. To further enhance stability and security, we strongly recommend using an optional **GTO/PRO® Automatic Gate Lock** (see *Accessory Catalog*) with your dual gates.

IMPORTANT: You need to determine which side of the driveway you will mount the control box. From this point on the gate and gate operator on the same side as the control box will be referred to as the **MASTER** gate and gate operator. The gate and gate operator on the opposite side of the driveway from the control box will be referred to as the **SLAVE** gate and gate operator.

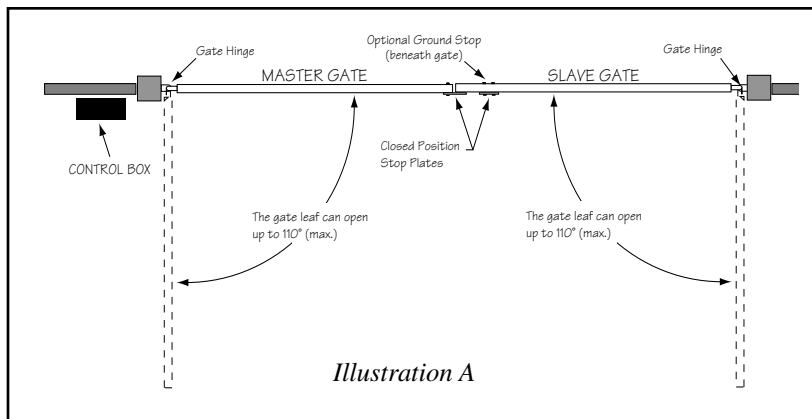

Step 1

Detach the gate operators from the gates and move the gates to their closed position (*Illustration A*). Using appropriate hardware for your type of gate (U-bolts for tube or chain link; screw or bolts for wood or metal) attach the *closed position stop plate* (**horizontally**) about mid height on the MASTER gate frame. **Do not** tighten it completely at this time. Slide the stop plate toward the frame of the SLAVE gate leaf until they touch (*Illustration B*). Once you have moved the stop plate to the correct position, tighten its hardware completely.

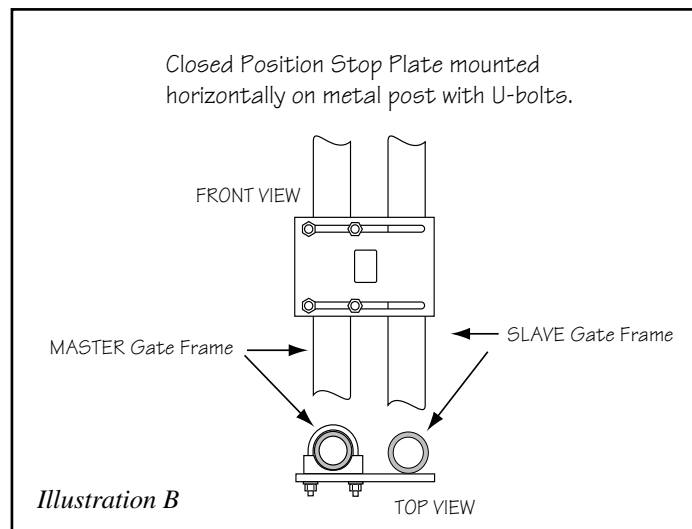

NOTE: The optional ground stop post is used to provide a secure point for the SLAVE gate to close against. If you will be using the GTO/PRO Horizontal Gate Lock accessory with your gate operator system, the closed position ground stop is **REQUIRED**, as shown in Steps 2 and 3 on the next page.

Step 2

Install a low profile ground stop (*not provided*) beneath the SLAVE gate stop plate.

The ground stop needs to be positioned near the end of the gate as shown in *Illustration A* and may be made of metal or concrete and should be firmly secured in the ground (we recommend setting it in concrete).

Step 3

Attach a vertical closed position stop plate to the SLAVE gate.

Using appropriate hardware for your type of gate attach the vertical *closed position stop plate* to the SLAVE gate frame at the point where it will come in contact with the ground stop post.. **Do not** tighten it completely at this time. You must slide the closed position stop plate toward the *ground stop* until they touch (*Illustration C*). Once you have moved the stop plate to the correct position, tighten its hardware completely.

NOTE: For a push-to-open installation (gate opens *out* from the property) attach the closed position stop plate to the **outside** of the gate.

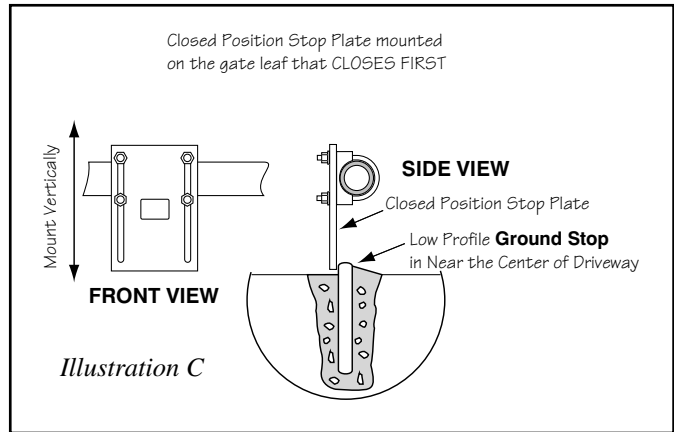

At this stage of the installation, the operators should be installed on the gate leaves and closed position stops should be in place.

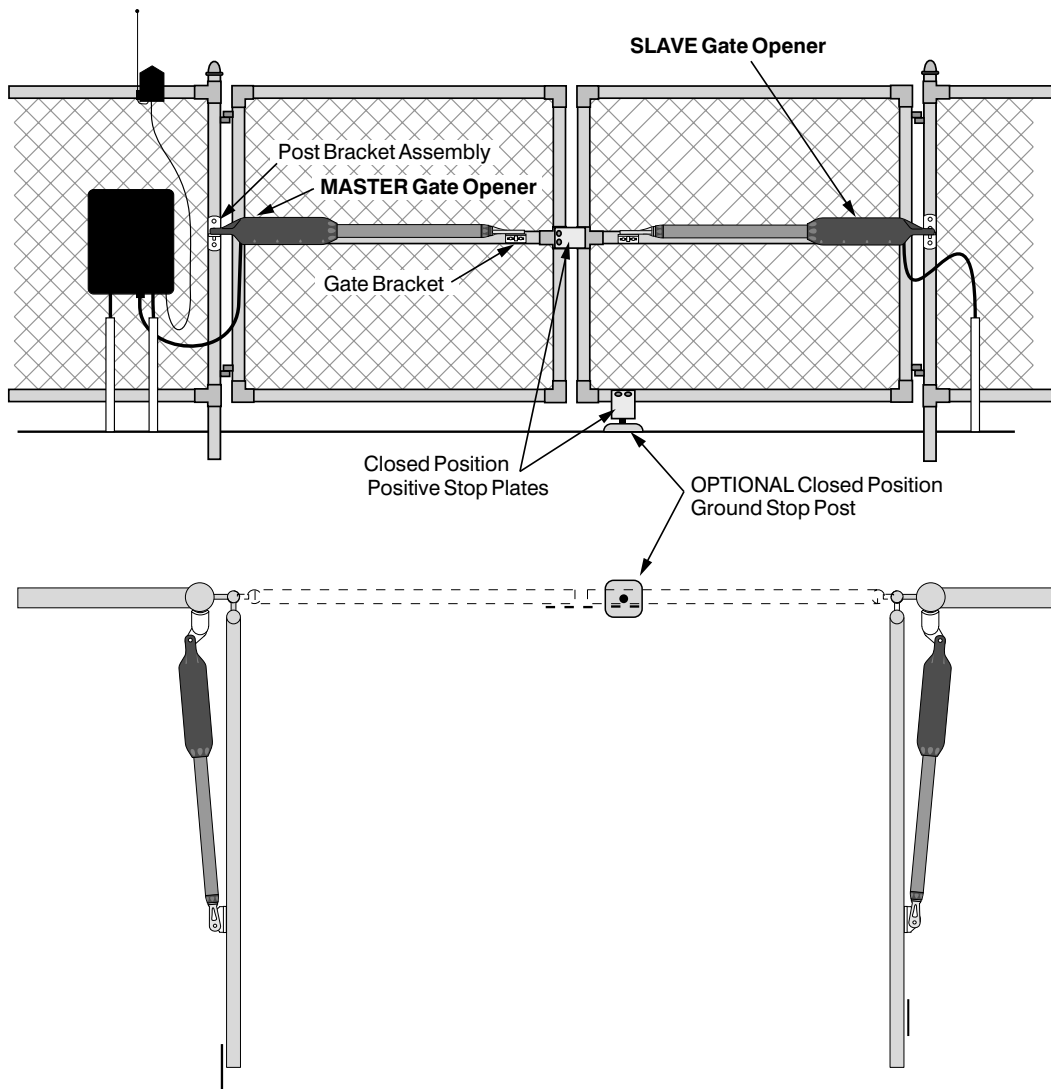

Mounting the Control

Step 1

Mount the control box using the screws (*provided*) or another secure mounting method. The control box must be mounted at least **3 feet above the ground** to protect it from rain splash, snow, etc., and at least **3 feet from an AC power source** to prevent electrical interference.

Use mounting holes and screws provided to mount control box to a secure surface.

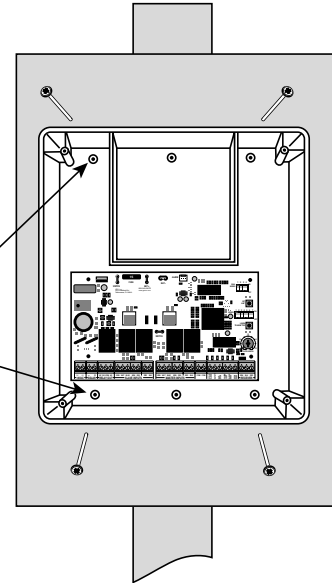

NOTE: The battery that came with your GTO/PRO® 4000/4200, **MUST** be placed in the top (horizontal) battery slot with the terminals on the **RIGHT**. The extra (vertical) battery slot is for an optional second battery. An optional second battery can be used for solar and/or high traffic applications, if needed..

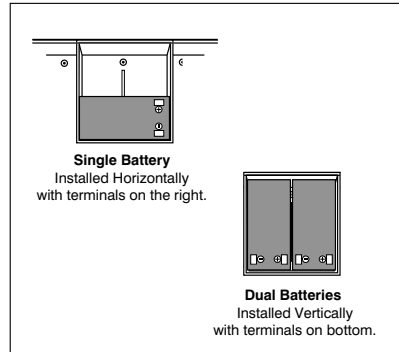

Step 2

Make sure the control box power switch is in the **OFF** position. The ON/OFF Switch is located on the bottom of the control box. Remove the control box cover and slide the battery into position with its terminals to the **RIGHT** (*see illustration*). Connect the **BLACK** battery wire to the **NEGATIVE (-)** battery terminal. Connect the **RED** battery wire to the **POSITIVE (+)** terminal. *Pay close attention to the color of the wires. If the wires are connected incorrectly, the control board will be damaged. NEVER insert the battery with the terminals to the left.*

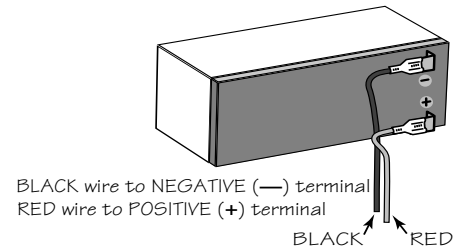

Connecting Operator Power Cables

Step 3

Strip approximately $\frac{3}{16}$ " of insulation from each wire of the power cable. Twist each exposed wire tightly (there are seven [7] wires inside the power cable sheath). Loosen sealing nut on strain relief hub at bottom of control box. Insert power cable into control box through strain relief. Thread approximately 6" of the power cable into the control box and retighten sealing nut until the power cable locks into place.

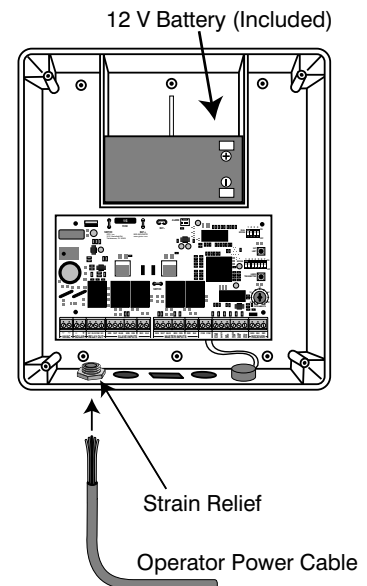
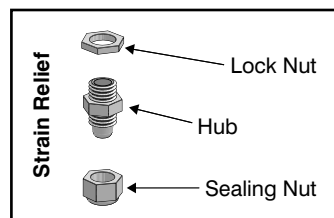

MASTER Operator

Step 4

Insert the stripped power cable wires into the appropriate terminals on the **MASTER OPERATOR** terminal block. The green wire should be inserted into the **GRN** terminal, the blue wire into **BLU**, the orange wire into **ORG**, black wire into **BLK**, and the red wire into the **RED** terminal.

Tighten the set screws against the end of the wires. A dab of petroleum jelly on each terminal will help prevent corrosion.

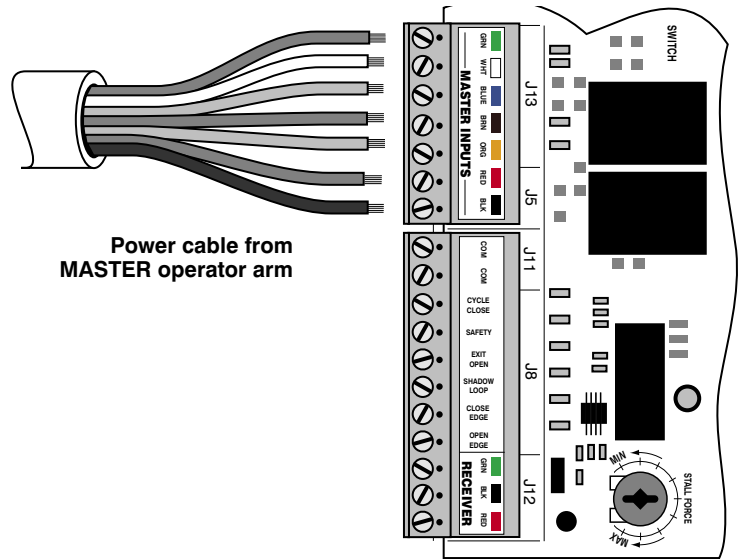
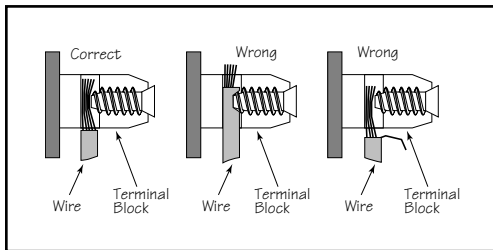

SLAVE Operator

Step 5

Review the **Installation Overview** illustration on *page 12* before proceeding.

Cut a slot into the driveway to accommodate PVC conduit (*not provided*). The buried conduit will protect the 40 foot power cable from automobile tires, lawn mower blades, weed eaters, and grazing animals. Pull the 40 foot second operator power cable through the conduit and secure them into the slot in the driveway.

Step 6

Strip approximately $\frac{3}{16}$ " of insulation from each wire of the **50 foot power cable**. Twist each exposed wire tightly. Insert the second operator power cable upward through the **right strain relief** (if necessary, loosen the sealing nut). Thread approximately 4" of wire into the control box. Retighten strain relief (on the **black sheath** of the power cable) until the power cable locks into place.

Insert the stripped wires of the power cable into the appropriate terminals on the **SLAVE OPERATOR** terminal block. The green wire should be inserted into the **GRN** terminal, the blue wire into **BLU**, the orange wire into **ORG**, black wire into **BLK**, and the red wire into the **RED** terminal.

Tighten the set screws against the end of the wires.

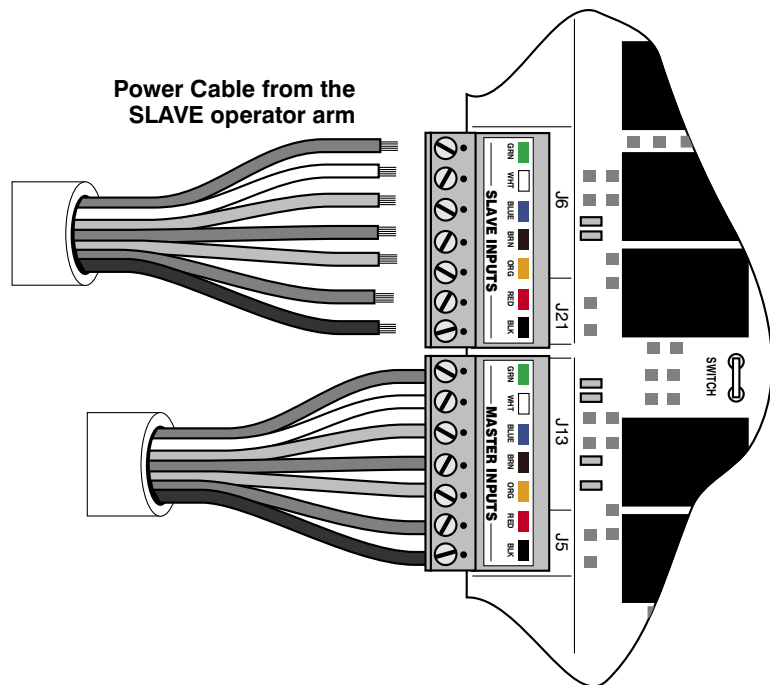

Powering the System

Installation of the Transformer

IMPORTANT:

- The transformer is designed and intended for indoor use. If the transformer can be plugged only into an outside electrical outlet, a weatherproof cover or housing (available at local electrical supply stores) **must** be used.
- All low voltage wire used with the GTO/PRO® 4000/4200 Gate Operator must be 16 gauge dual conductor, multi-stranded, direct burial wire (*see page 23 and the Accessory Catalog*). **Do not run more than 1000 feet of wire.**
- If your gate is more than 1000 ft. from an ac power source, you will need to use from 10 to 30 watts of solar charging power to charge the battery (*see Accessory Catalog*). Refer to the **Solar Panel and Gate Activity** chart below.

OPTIONAL Solar Panel and Gate Activity

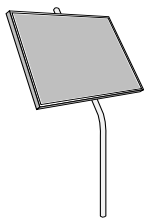

The table and map illustrate the maximum number of gate cycles to expect per day in a particular area when using from 15 to 30 watts of solar charging power. (*see Accessory Catalog*). The figures shown are for winter

(minimum sunlight) and do not account for the use of any accessory items. *Accessories connected to your system will draw additional power from the battery.*

NOTE: A minimum of 15 watts of solar charging power is required for GTO/PRO 4000/4200 dual gate systems, with a maximum of 30 watts. An optional second battery can be used for solar and/or high traffic applications, if needed. Consult *Solar Panel Installation Instructions* for further information.

Winter Ratings	Zone 1	Zone 2	Zone 3
12 v dual gate (15 watts) solar charger	3	6	10
12 v dual gate (20 watts) solar charger	4	8	13
12 v dual gate (25 watts) solar charger	5	10	16
12 v dual gate (30 watts) solar charger	6	12	19

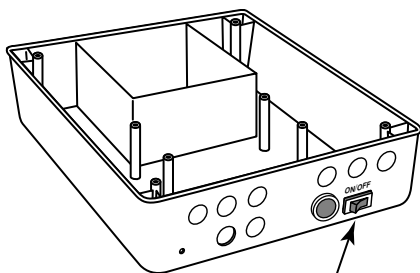

ON/OFF Switch

Step 1

Make sure the power switch is **OFF** before proceeding to the next step.

Step 2

Select the electrical outlet into which you will plug the transformer. Measure the distance from this outlet to the control box following the path where the wire will be laid. After you have measured how much wire is needed, cut the wire to the appropriate length. (Not more than a 1,000 feet).

IMPORTANT INFORMATION ABOUT LOW VOLTAGE WIRE

The only wire acceptable for use with GTO products is 16 gauge multi-stranded, low voltage, PVC sheathed wire. This particular gauge enables the transformer to provide an adequate charge through the control board to the battery at distances up to 1000 ft.

DO NOT use telephone wire or solid core wire. Unlike multi-stranded wire, these types of wire are inadequate for use with your gate operator system. Telephone wire and solid core wire do not deliver enough voltage for your gate operator to function and will cause the system to go into a condition known as "low voltage lockout."

NEVER splice wires together. Splicing permits corrosion and seriously degrades the wire's ability to carry an adequate current.

Step 3

Lay the measured length of low voltage wire in a trench following a path from the selected electrical outlet to the control box. Wires coming up from the ground should be run through PVC conduit to protect them from lawn mower blades, weed eaters, and grazing animals. Be sure to bury the wire laid in the trench.

Step 4

Feed the low voltage wires upward through the strain relief opening on the lower left of the control box. Pull 6" to 8" of wire into the control box and tighten the strain relief screw to secure the wires.

⚠ WARNING! DO NOT PLUG THE TRANSFORMER INTO AN OUTLET DURING THIS STEP! THE TRANSFORMER MUST ONLY BE PLUGGED INTO AN OUTLET DURING STEP 7!!

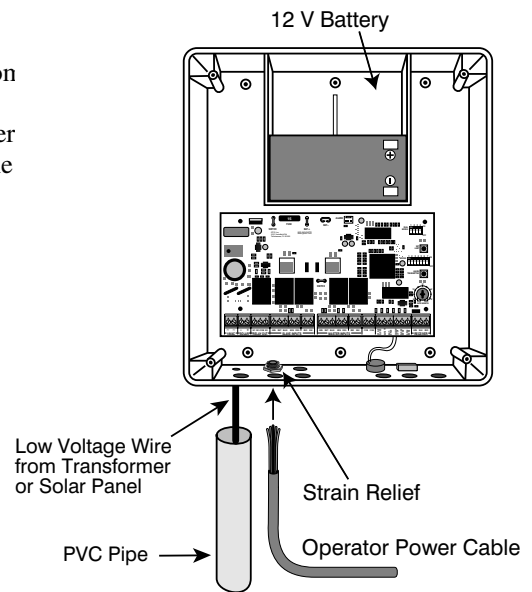

Step 5

Strip $\frac{3}{16}$ " off the ends of the low voltage wire and twist tightly. Attach these ends to the **18VAC** terminals located on the **POWER IN** terminal block (see illustration at right). **Be certain not to let the exposed wires touch each other!**

Insert one transformer wire into an **18VAC** terminal. Insert the other transformer wire into the remaining **18VAC** terminal. The transformer wires can be connected to the **18VAC** terminals regardless of color.

Tighten set screws against exposed end of wires. A dab of household petroleum jelly on each terminal will help prevent corrosion.

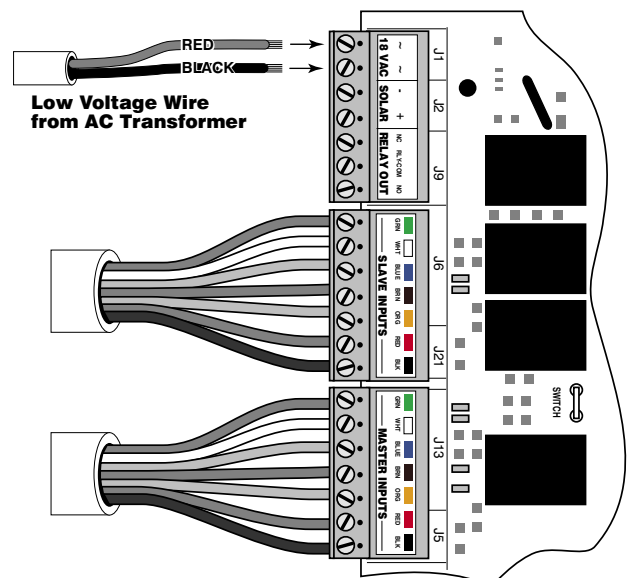

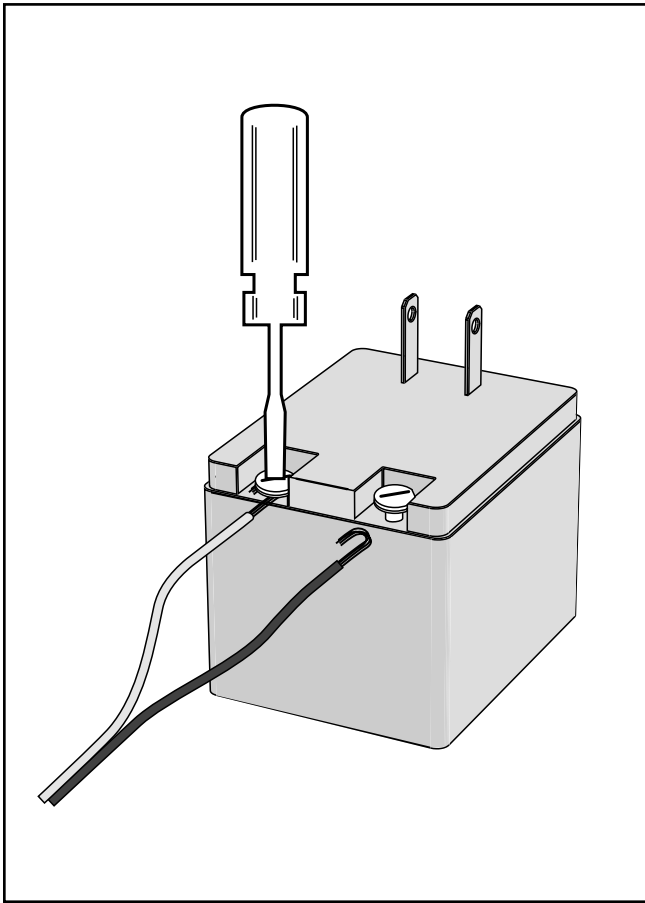

Step 6

Strip $\frac{1}{2}$ " of insulation from the ends of the low voltage wire. Attach these stripped ends to the transformer terminals.

A dab of household petroleum jelly on each terminal will help prevent corrosion.

Make sure the exposed wires do not touch each other!

Step 7

Plug the transformer into the electrical outlet.
(Use of a surge protector with the transformer is strongly recommended.)

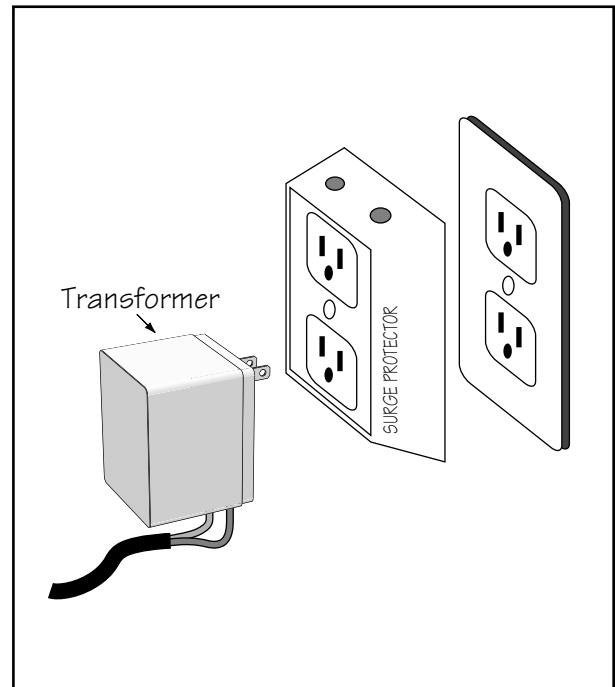

CONTROL BOARD SETTINGS

DIP Switches

Main DIP Switch Settings (MODES)

DIP Switch #1 - Soft Start/Stop

The Soft Start/Stop feature slowly starts the gate as it begins to open and slows the gate as it comes to the closed position. This saves wear and tear on the gate and gate operator system.

DIP Switch #2 - Warning Buzzer

The Warning Buzzer alerts you when the gate operator is beginning to either open or close the gate. It sounds for the first 2 seconds in each direction. It also sounds a warning when the gate obstructs two times in one cycle. Switching this to OFF only disables the open and close warning not the obstruction warning.

DIP Switch #3 - Auto-Close

With the Auto-Close switch in the OFF position the gate will remain open until it receives another signal from an activation device such as a transmitter, keypad, or push button control. With the Auto-Close switch in the ON position the gate operator will automatically close the gate, if the gate is in its open limit position. The time the gate will remain open is determined using DIP Switches #6 and #7.

DIP Switch #4 - Push/Pull-to-Open

If your gate opens into the property the DIP Switch is set to OFF (factory). If your gate opens out from the property the DIP Switch must be set to the ON position.

DIP Switch #5 - B2/D1 Mode

This DIP Switch must remain in the OFF position unless the gate operator is going to be used by a guard or gate attendant, who can only open the gate when constant pressure is applied to a push button control device.

DIP Switches #6 and #7

The combination of these two switches determines the amount of time the gate will remain open when DIP Switch #3 is set in the ON position.

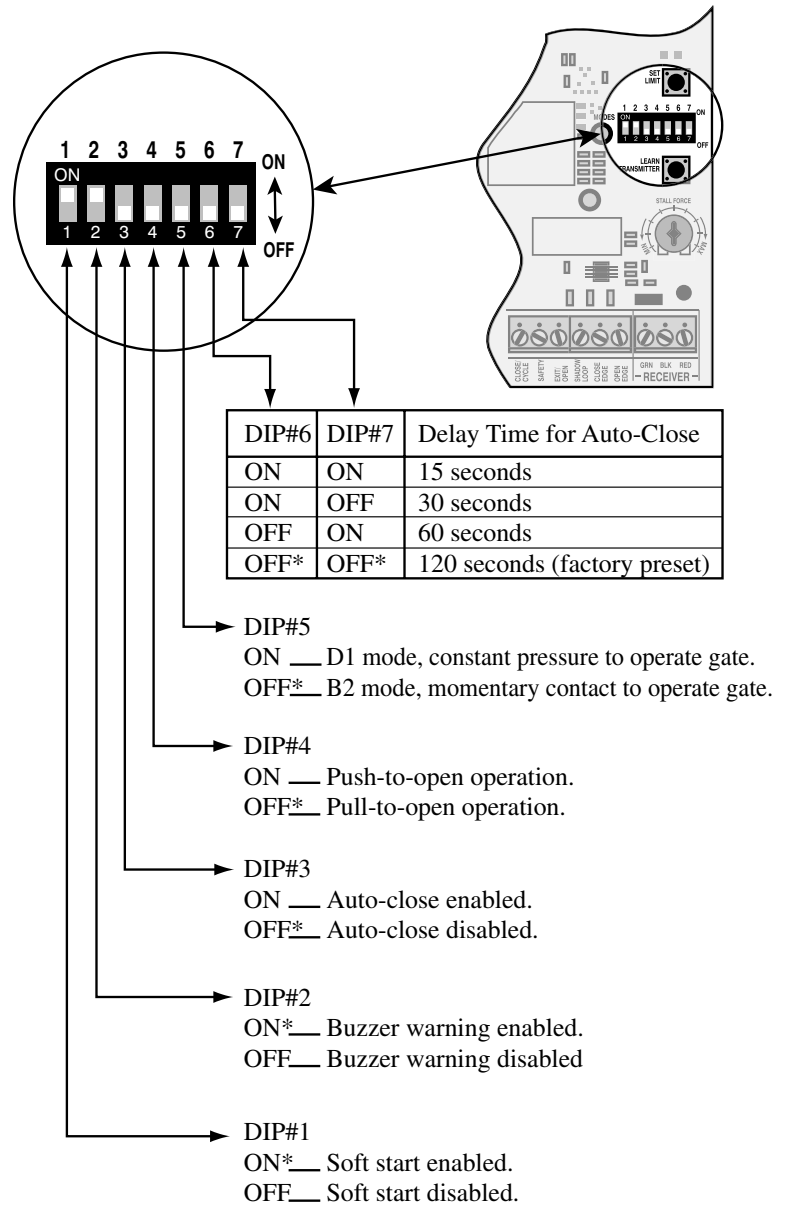

* Factory Preset.

IMPORTANT CONTROL BOARD SETTINGS:

CONTROL BOARD DIP SWITCH #1 is factory preset in the ON position and MUST remain in the ON position. Changing this setting can damage your gate, gate opener and possibly void your warranty!

Dual Gate DIP Switch Settings (DUAL MODES)

DIP Switches #1 and #2 (Factory Set OFF/OFF)

The combination of DIP Switches #1 and #2 will determine the sequence dual gates will open and close.

DIP Switch #3 - Additional Delay (Factory Set OFF)

To add 4 seconds to the standard 4 seconds, a total of 8 seconds delay, sequence delay switch to ON.

DIP Switch #4 - Used to set MASTER and SLAVE gate closed position limits (next section).

#4 ON = when setting closed limit for SLAVE gate.

#4 OFF = when setting closed limit for MASTER gate.

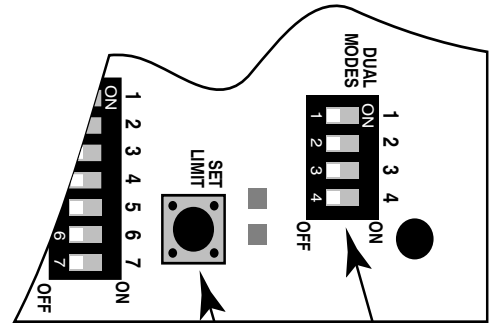

- | | | |
|---------------------------|--|---|
| #1 OFF & #2 OFF | | Factory setting.
Single Arm (Master Only) operation. |
| #1 ON , #2 OFF and #3 OFF | | MASTER gate starts to open 2 seconds before SLAVE gate / SLAVE gate starts to close 4 seconds before MASTER gate. |
| #1 ON, #2 OFF and #3 ON * | | MASTER gate starts to open 2 seconds before SLAVE gate / SLAVE gate starts to close 8 seconds before MASTER gate. |
| #1 OFF, #2 ON and #3 OFF | | MASTER and SLAVE gates open simultaneously / SLAVE gate starts to close 4 seconds before MASTER gate. |
| #1 OFF, #2 ON and #3 ON | | MASTER and SLAVE gates open simultaneously / SLAVE gate starts to close 8 seconds before MASTER gate. |

* REQUIRED SETTING for use with GTO/PRO Horizontal Gate Lock accessory.

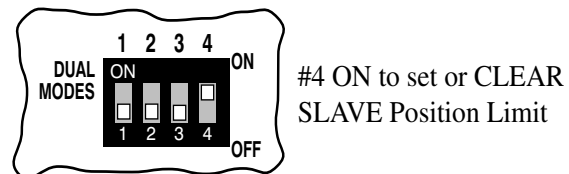
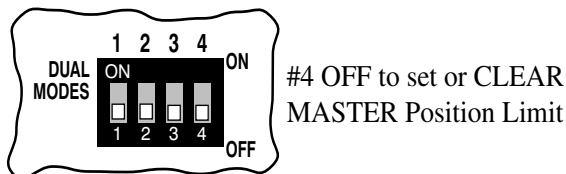

Setting the Closed Position Limits

TURN CONTROL BOX ON

Your GTO/PRO® 4000/4200 has two Limit Settings

1) **OPEN Limit setting:** (Gate in the OPEN POSITION / FACTORY SET NOT ADJUSTABLE) The open limit setting is the fully open position.

2) **CLOSED Limit setting:** (Gate in the CLOSED POSITION) To achieve optimum closed position, you are required to complete the following SEVEN STEPS:

Step 1

Confirm that the power switch is in the ON position, and the gates are in the OPEN POSITIONS.

Step 2

Activate your operators by pressing the entry transmitter button. Your gates should now be moving from the fully open positions toward their closing position. Prepare to STOP gate by pressing the entry transmitter button again when the first gate reaches the desired closed position. This step may be repeated until desired close position is achieved. Once the desired CLOSED position has been achieved, proceed to step 3.

Step 3

With the first gate in the desired closed position. Program the closed limit setting by setting the number 4 DIP switch on the DUAL MODES switches to the OFF position (if the MASTER gate closed first) or the ON position (if the SLAVE gate closed first) then PRESS & HOLD the “SET LIMIT” button on the control board for 5 seconds.

Step 4

Press the transmitter button and allow the gates to return to the fully open position. YOUR FIRST GATE'S CLOSED POSITION LIMIT IS NOW PROGRAMMED.

Step 5

Activate your operators again by pressing the entry transmitter button. Your gates should now be moving from the fully open positions toward their closing position. The first gate will stop at the spot you just programmed and the second gate will continue to close until you press the transmitter button again. The optimum CLOSED POSITION for the second gate is when it closes firmly, without excess tension, against the first gate. This step may be repeated until desired close position is achieved. Once the desired CLOSED position has been achieved, proceed to step 6.

Step 6

With the second gate in the desired closed position. Program the closed limit setting by setting the number 4 DIP switch on the DUAL MODES switches to the ON position (if the MASTER gate closed first) or the OFF position (if the SLAVE gate closed first) then PRESS & HOLD the “SET LIMIT” button on the control board for 5 seconds.

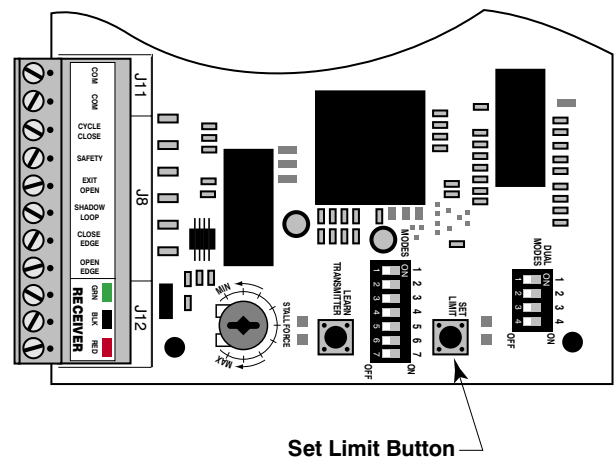

Step 7

Press the transmitter button and allow the gates to return to the fully open position. BOTH YOUR MASTER AND SLAVE GATE'S CLOSED POSITION LIMITS ARE NOW PROGRAMMED.

TESTING YOUR CLOSED LIMIT SETTING:

Press your entry transmitter and allow your gates to close. If CLOSED positions are not correct or need to be changed, you will need to CLEAR your CLOSED LIMIT settings and follow Steps 1-7 again.

CLEARING PROGRAMMED CLOSED LIMIT SETTING:

If you make a mistake and set the limit at the wrong position – press your transmitter to return the gates to their fully opened positions, then press and hold the "SET LIMIT" button for 10 seconds. This will clear the memory for the closed limit

Setting Your Personal Transmitter Code

All GTO transmitters are set to a standard code at the factory and are ready to operate your GTO/PRO® 4000/4200 Gate Operator. For your safety and security, however, we **strongly recommend** that you replace the factory setting with your own personal code. Follow the directions below:

1. Remove the Transmitter Cover

Grasp the sides of the access cover and slide it away from the transmitter button (see illustration). When the access cover is removed, the battery and the DIP switches will be exposed. To set a new code, use a small screwdriver to move the switches.

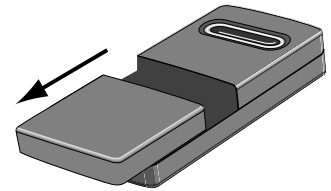

2. Set the transmitter DIP Switches

There are nine (9) transmitter DIP switches; each can be placed in three different positions (+, 0, -). **DO NOT** set all the switches in the same position, such as all +, all 0, or all -. Once the DIP switches have been set to a personal code, replace and close the access cover.

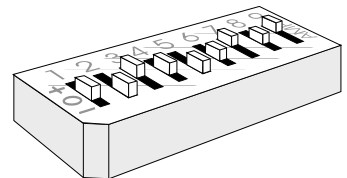

WARNING: No other adjustments should be made inside the transmitter.

3. "Teach" the New Code to Control Board Memory

- A. Press and hold transmitter button.
- B. Press and hold the **LEARN TRANSMITTER** button on the control board for 5 seconds.
- C. Release transmitter button.
- D. Release **LEARN TRANSMITTER** button. The new code is stored in control board memory.

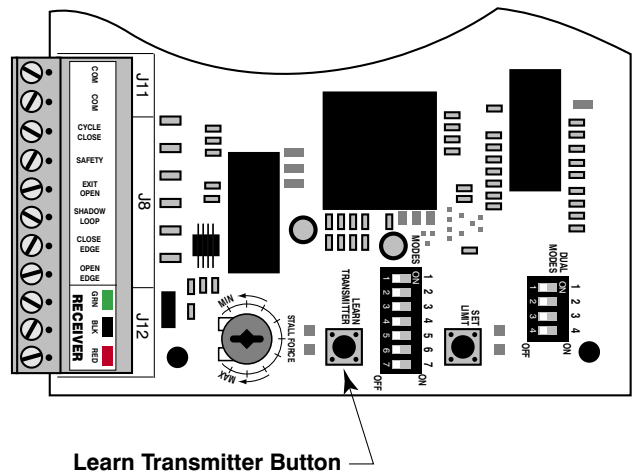

Obstruction Sensitivity Potentiometer

IMPORTANT: For safety reasons the obstruction setting or **Stall Force** on the GTO/PRO 4000 control board comes from the factory set at **MIN** (minimum). In many gate installations this setting will need to be adjusted to overcome the weight and size of the gates.

The **Stall Force** potentiometer on the control board operates like a volume control on a radio. It controls the obstruction sensitivity (or the amount of force the opener will apply to an obstruction) before it automatically stops and reverses direction for approximately two (2) seconds.

Use a small slotted screwdriver to turn the arrow in the center of the potentiometer. Adjust the sensitivity from the **MINIMUM** position where the gate operates without obstructing from its own weight or the wind conditions in your area.

NOTE: You may need to increase the stall force in cold weather due to increased resistance from gate hinges.

ALWAYS KEEP SAFETY AT THE TOP OF YOUR LIST WHEN ADJUSTING OR SERVICING YOUR AUTOMATIC GATE OPENER!

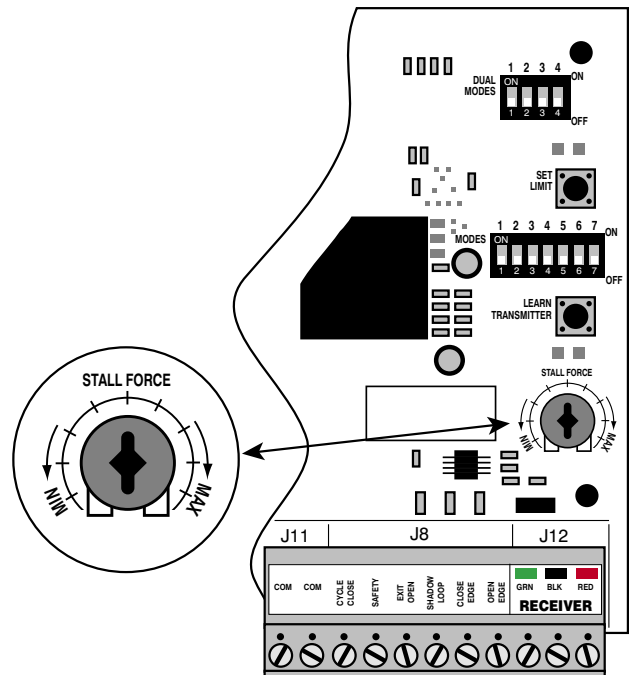

Installing the Receiver

Use the transmitter to check the range of the receiver *before permanently mounting it*.

Consider the following when mounting the receiver:

- Standard receiver cable length is 10 feet (receivers with a longer cable are available as special order items; *call the GTO Sales Department*). NEVER splice receiver cable!
- **Run the cable through PVC conduit to protect it from damage.**
- DO NOT run cable through metal conduit because the receiver signal range will be decreased.
- DO NOT run cable in conduit containing ac wiring.
- DO NOT mount receiver on a metal fence or post; doing so will decrease signal range.
- The receiver range can vary from 50 to 100 feet depending upon weather, topography, and external interference.
- **DO NOT mount upside down.**

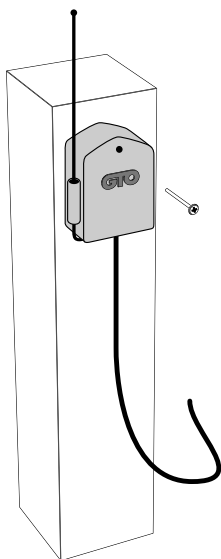

FCC Regulation

This device complies with FCC rules Part 15. Operation is subject to the following conditions:

1. This device may not cause harmful interference.
2. This device must accept an interference that may cause undesired operation.

Transmitter distance may vary due to circumstances beyond our control. **NOTE: The manufacturer is not responsible for any radio or TV interference caused by unauthorized modifications to this equipment. Such modifications could void the user's authority to operate the equipment.**

Connecting Additional Safety Devices

Although GTO strongly recommends the use of additional safety devices, we do not endorse any specific brand names. Only use products that are certified and listed to be in compliance with any applicable UL standards (United Laboratories) and national and regional safety codes.

Call GTO Sales at 1-800-543-4283 for information on compatible products for your specific application.

The GTO/PRO® 4000 will ONLY accept accessory devices with normally open contact output.

Contact Sensors (safety edges)

If not installing a contact sensor skip to next section.

PLEASE NOTE: Contact sensors are not *included* with the GTO/PRO® 4000.

The GTO/PRO® 4000 is equipped with built-in obstruction sensitivity. The operator is designed to stop and reverse the gate within 2 seconds when it comes in contact with an obstruction. However, obstruction sensitivity, although functioning properly, *may not be sensitive enough to prevent bodily injury in some circumstances*. To augment your protection against entrapment, *GTO recommends using some form of additional safety device*. When installed, contact sensors must be mounted in compliance with UL 325, Underwriters Laboratories safety standard for gate operators. Review page 5 for information about mounting requirements for safety edges ("contact sensors").

Refer to the sensor manufacturer's instructions for information about installing these devices on a vehicular gate.

- ⚠ Make sure the power switch to the operator is turned off before connecting safety device wiring to the terminal blocks. Unplugging the transformer does not turn power to the operator OFF.**

Contact Sensor Input Connection:

Connect one of the OPEN EDGE contact sensor wires to the COMMON (COM) terminal and the other to the OPEN EDGE terminal on the GTO/PRO® 4000 control board.

Connect one of the CLOSE EDGE contact sensor wires to the COMMON (COM) terminal and the other to the CLOSE EDGE terminal on the GTO/PRO® 4000 control board.

Activation of a contact sensor while the gate is in motion will cause the gate to stop and reverse within two (2) seconds.

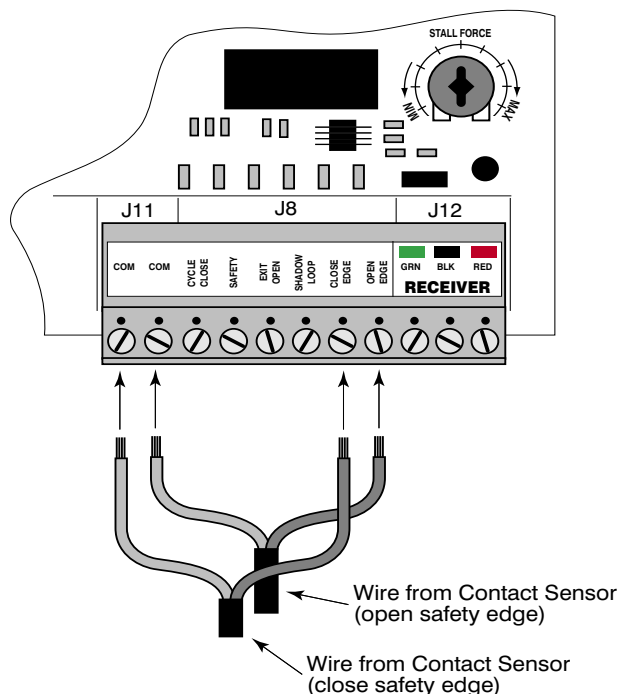

Non-Contact Sensors (photo beams)

If not installing a non-contact sensor skip to next section.

PLEASE NOTE: Non-contact sensors are not *included with* the GTO/PRO® 4000.

The GTO/PRO® 4000 can also accept "Safety" input from normally open "dry-contact" output devices such as photo beams connected to the SAFETY input terminal.

Refer to the sensor manufacturer's instructions for information about installing these devices on a vehicular gate.

⚠ Make sure the power switch to the operator is turned off before connecting safety device wiring to the terminal blocks. Unplugging the transformer does not turn power to the operator OFF.

Non-Contact Sensor Connection:

Connect one of the non-contact sensor dry contact output wires to the **COMMON (COM)** terminal and the other to the **SAFETY** terminal on the GTO/PRO® 4000 control board.

This input is ONLY monitored when the gate is closing. Activating the non-contact sensor (obstructing the safety beam path) will cause the gate to reverse to the fully open position.

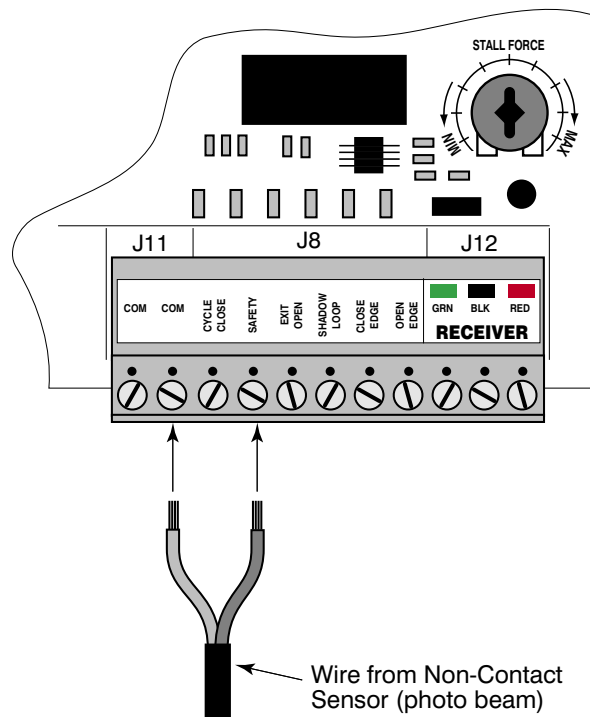

Shadow Loop

If not installing a shadow loop skip to next section.

PLEASE NOTE: Non-contact sensors are not *included with* the GTO/PRO® 4000.

Refer to the sensor manufacturer's instructions for information about installing these devices on a vehicular gate.

⚠ Make sure the power switch to the operator is turned off before connecting safety device wiring to the terminal blocks. Unplugging the transformer does not turn power to the operator OFF.

Shadow Loop Connection:

Connect one of the shadow loop wires to the **COMMON (COM)** terminal and the other to the **SHADOW LOOP** terminal on the GTO/PRO® 4000 control board.

The shadow loop is a detector located with the moving path of the gate to prevent the gate from closing when a vehicle is in the path.

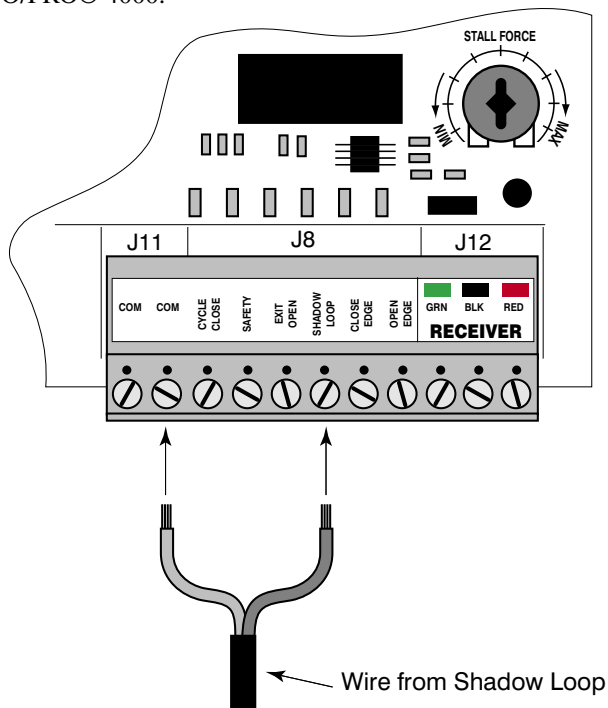

Connecting Accessories

If not connecting accessories skip to next section.

The GTO/PRO® 4000 can accept NORMALLY OPEN CONTACT accessories, such as; Push Button Entry Devices and Key Pads.

Refer to the sensor manufacturer's instructions for information about installing these devices on a vehicular gate.

⚠ Make sure the power to the operator is turned off before connecting safety device wiring to the terminal blocks. Unplugging the transformer does not turn power to the operator OFF.

Accessory Input Connection:

Connect one of the accessory wires to the **COMMON (COM)** terminal and the other to the **CYCLE CLOSE** terminal on the GTO/PRO® 4000 control board.

Each activation of the accessory will cause the gate to cycle as follows:

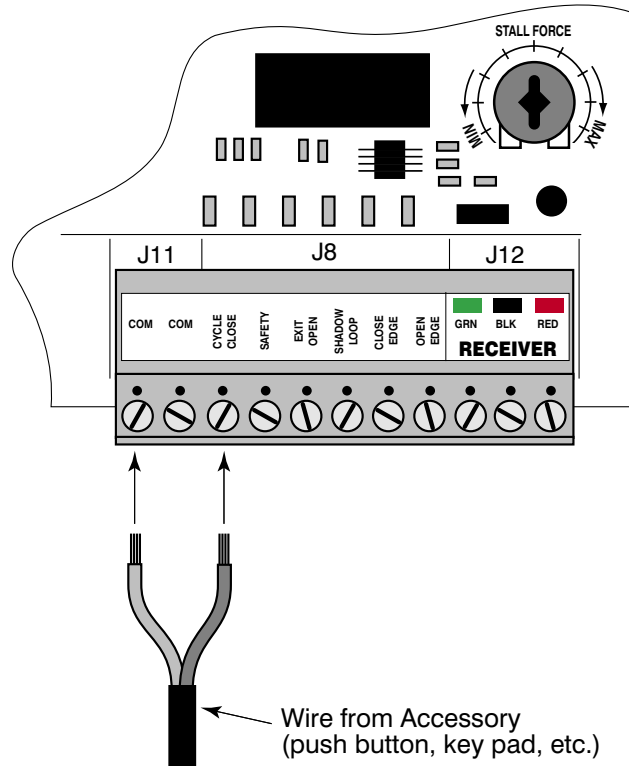
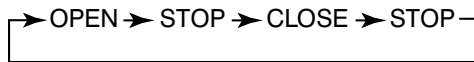

Output Relay

The output relay provides N/O and N/C contact. N/O contact functions only when gate is moving. N/C contact functions only when gate is at rest. Relay can switch up to 36 volts A/C or D/C and can be used for strobe type warning lights, to turn on safety beams, etc.

Push to Open Installation

Determining The Mounting Position of The Post Bracket Assembly

⚠ Swinging gates shall not open into public access areas!

A "Push-to-Open" gate opens *out* from the property. If you have a pull-to-open gate (gate opens *into* the property), return to page 13.

In a PUSH-TO-OPEN installation the operators are installed while the gates are in the **closed** position.

NOTE: An optional 12" long Post Pivot Bracket (R4KPTO) is available for installations that need a greater distance to achieve the safe gate and gate operator clearance (2 inches).

Step 1

With the gates **closed**, adjust the post bracket assembly and the gate bracket until the operator is level. While holding the operator level, use C-clamps to temporarily keep the post bracket assembly and gate bracket in their respective positions on the fence post and gate.

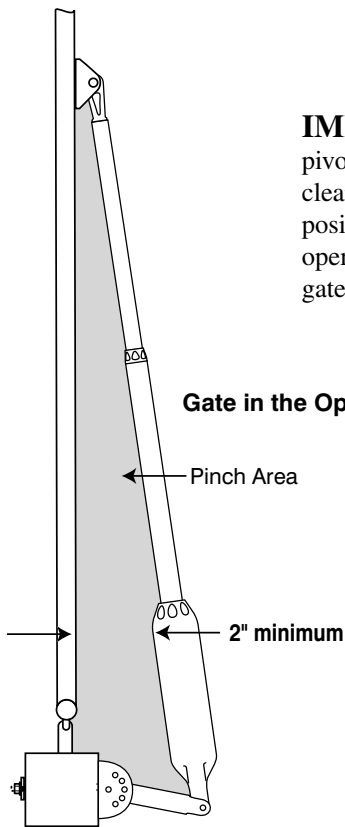
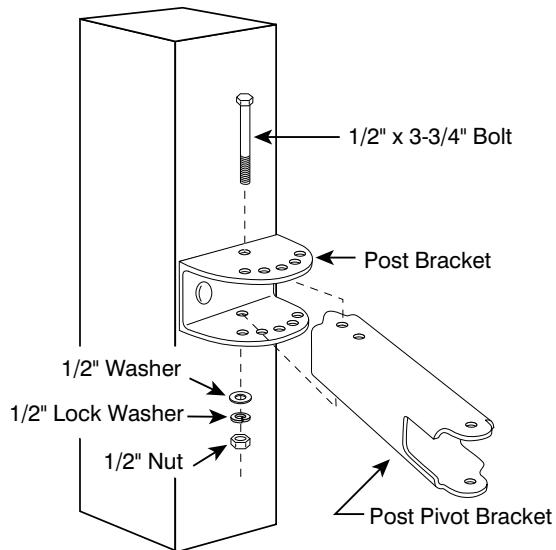

IMPORTANT: While determining the mounting point for the post pivot bracket assembly be sure that the position allows for maximum clearance between the gate and the operator in both the open and closed positions, as shown in the diagrams below. This clearance will give the operator the most efficient leverage point for opening and closing the gate and more importantly provides the least possible pinch area.

Step 2

After verifying that you have the best position for the post pivot bracket, insert the $\frac{5}{16}$ " x $1 \frac{3}{4}$ " bolt through the aligned holes of the post bracket and post pivot bracket and fasten it with the $\frac{5}{16}$ " washer and nut.

IMPORTANT: If you loosened the clamp on the post bracket to achieve the optimum position, tighten it in its new position and recheck the gate bracket with the gate in the open position (move the gate bracket and re-clamp it if necessary).

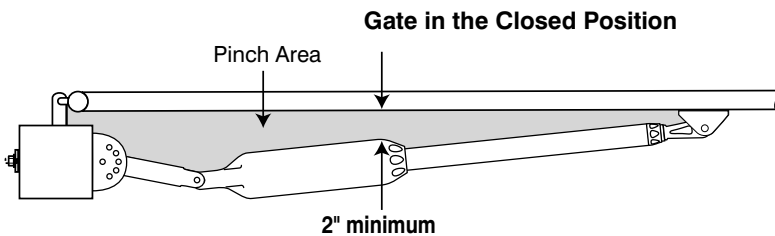

Step 3

With the gate in the **fully closed position** and the operator retracted, swing the operator to the gate. Mark reference points for bolt holes on gate cross member through middle of gate bracket slots. The operator must be level. Drill $\frac{3}{8}$ " holes into the gate cross member as marked. Fasten gate bracket to cross member using (2) $\frac{3}{8}$ " x 3" bolts, washers, lock washers, and nuts. Attach the operator to the post bracket assembly and gate bracket using clevis pins, bushings, and hairpin clips.

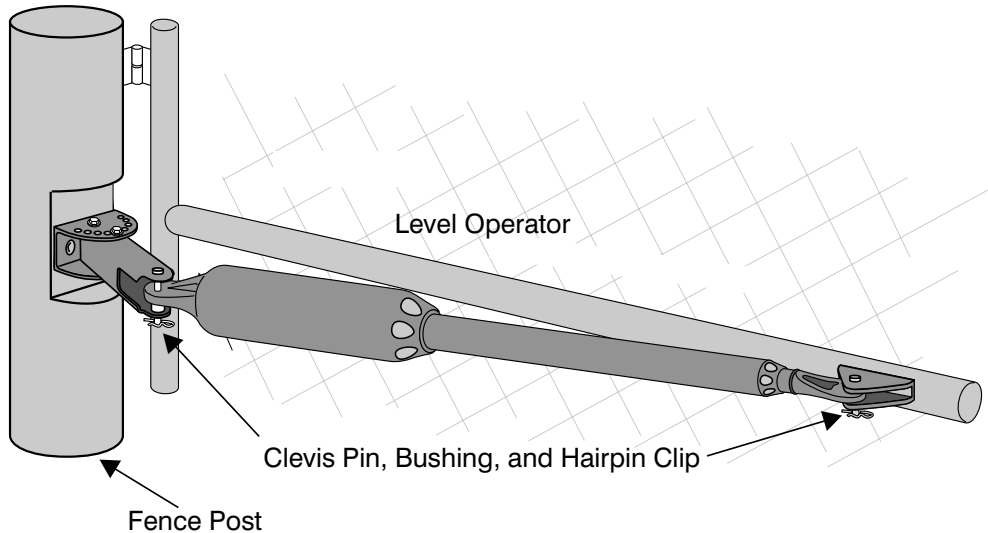

Step 4

Make sure the control box power switch is **OFF**. Use a small screwdriver to move the **Number 4** DIP switch from the factory setting (OFF / Pull-To-Open) to **ON for Push-To-Open**. Turn power switch **ON**. The control board is now configured to *push* the gate open.

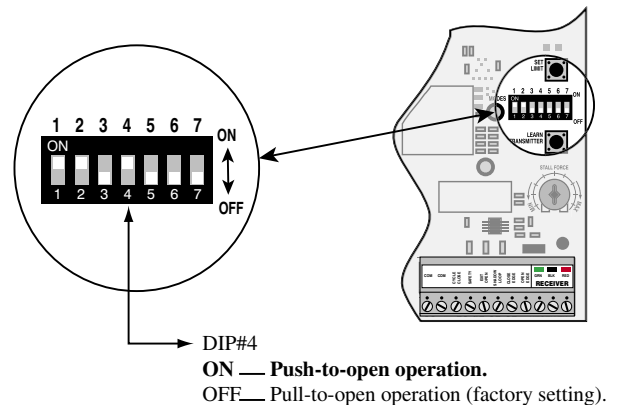

Setting the Open Position Limit

Step 1

Confirm that the power switch is in the ON position, and the gate is in the CLOSED POSITION.

Step 2

Activate your operator by pressing the entry transmitter button. Your gate should now be moving from the closed position toward the open position. Prepare to STOP gate by pressing the entry transmitter button again when the gate reaches the desired open position. This step may be repeated until desired close position is achieved. Once the desired OPEN position has been achieved, proceed to Step 3.

Step 3

With the gate in the desired open position PRESS & HOLD the "SET LIMIT" button on the control board for 5 seconds.

Step 4

Press the transmitter button and allow the gate to return to the closed position. YOUR GATE'S OPEN POSITION LIMIT IS NOW PROGRAMMED.

TESTING YOUR OPEN LIMIT SETTING:

Press your entry transmitter and allow your gate to open. If the OPEN position is not correct or need to be changed, you will need to CLEAR your OPEN LIMIT settings and follow steps one (1) to four (4) again.

CLEARING PROGRAMMED OPEN LIMIT SETTING:

If you make a mistake and set the limit at the wrong position – press your transmitter to return the gate to the closed position, then press and hold the "SET LIMIT" button for 10 seconds. This will clear the memory for the open limit position. Follow steps one (1) to four (4) again.

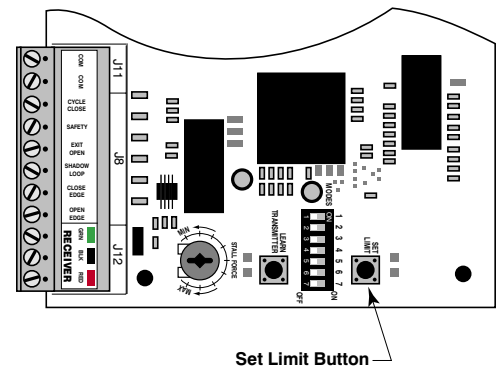

Maintenance & Troubleshooting

If your gate operator does not function properly after it is installed, use this guide before calling the GTO Service Department.

- On all gates weighing 250 lb. or more, routinely grease the ball bearing hinges at least 4 times a year; more frequently if the gates are near a coastal area.
- Keeping a few mothballs in the control box will discourage insects from entering it and damaging the control board.
- Clean the push-pull tube with a soft, dry cloth and apply silicone spray to it at least once per month.
- While oxidation is a normal part of weathering of equipment that is exposed to the elements, we recommend you apply silicone spray on the front and rear mounts to minimize this effect.

If the Operator Does Not Work

Check the Green LED on the Control Board:

IF THE LED IS OFF: This condition indicates a transformer power failure.

1. Test the transformer for voltage with a voltmeter. The acceptable range can be found in the **VOLTAGE LIMITS** chart on the next page. If the transformer test shows no voltage, then test the electrical outlet for voltage. If the outlet test shows voltage, then the transformer is dead and must be replaced. Allow the new transformer 12 hours to charge the battery before using the gate operator.
2. If the transformer test shows voltage, check the **POWER IN** terminal block on the control board for voltage. If the terminal block shows no voltage, look for broken or spliced wires.

Check the Red STATUS LED on the Control Board:

IF THE LED IS ON: but the unit is not working.

1. Check the battery in your transmitter and replace with a fresh one if needed..
2. Verify that the power cable is securely connected.
3. Replace the control board fuse if it is blown (**25 ampere fuse only - DO NOT USE A HIGHER RATED FUSE!**).

IF THE LED IS OFF:

1. Make sure the **ON / OFF** switch at the bottom of the control box is set to **ON**.
2. Check all connections for looseness and corrosion.

If the Operator is Working

The Gate **CLOSES** Then **Opens** Again on its Own:

1. Check the position of the mounting brackets and readjust if necessary.
2. Check the gate for binding or hinge damage.

The Gate **OPENS** Then **Closes** Again on its Own:

1. Check the position of the mounting brackets and readjust if necessary.
2. Check the gate for binding or hinge damage.

VOLTAGE RATINGS

18 Vac Transformer _____	18.0 to 22.0 Vac
5 W Solar panel (single) _____ measure voltage at panel and control box.	18.0 to 22.0 Vdc 300 mA
12 V Battery _____	12.0 to 13.5 Vdc 7.0 Ah
Charging circuit _____ measure voltage with battery connected	12.0 to 14.8 Vdc

GTO/PRO[®]
PROFESSIONAL ACCESS SYSTEMS

The GTO, Inc. Technical Service Department is open
Monday – Friday 8:00 A.M. – 5:00 P.M. (Eastern Time)

Telephone (800) 543-1236

Telephone (850) 575-4144

Fax (850) 575-8950 • Web site: www.gtopro.com www.gtopro

Repair Service

If your GTO/PRO® 4000/4200 Gate Operators are not operating properly, please follow the steps below:

1. First use the procedures found in the *Maintenance & Troubleshooting Guide* (see page 36).
2. If you are unable to solve the problem, call the **GTO Service Department** at (800) 543-1236, or (850) 575-4144. Refer to the serial number (located on the control box cover) and date of purchase when calling for assistance.
3. If repair or replacement of your gate operator is necessary, the Service Department will assign a **Return Goods Authorization (RGA) number** to you.
4. Securely pack the component(s) authorized for return to the factory. Include a copy of your sales receipt for the purchase of the product(s). Write the RGA number issued to you on the outside of the package in **LARGE BOLD PRINT**.
Ship the package(s) freight prepaid to: **GTO, Inc., 3121 Hartsfield Road, Tallahassee, Florida, USA 32303.**

NOTE: Products returned to GTO without a Return Goods Authorization (RGA) number in LARGE BOLD PRINT on the outside of the package WILL NOT be accepted. Also, items returned to GTO freight collect WILL NOT be accepted.

GTO/PRO®

PROFESSIONAL ACCESS SYSTEMS

Fax (850) 575-8950 • Web site: www.gtopro.com

E-Mail: techsupport@gtoinc.com

GTO, Inc.

3121 Hartsfield Road • Tallahassee, Florida, USA 32303 • (850) 575-0176 • Fax (850) 575-8912 •

Web site www.gtopro.com

Column Installation Information

IF THIS OPERATOR WILL BE USED WITH GATES THAT ARE MOUNTED ON MASONRY, BRICK, OR ROCK (etc.) COLUMNS:

READ THE FOLLOWING CAREFULLY BEFORE PROCEEDING

- A. The simplest solution is to install the operator in a push-to-open configuration. The minimum clearance is easier to achieve and clearance is no longer a problem, since the operator will be pushing the gate away from the column instead of pulling it toward the column. It is recommended that you place a steel plate between the operator mounting brackets and masonry surface for additional strength.
- B. If a push-to-open installation is impossible due to traffic hazards, terrain, etc., another option is to re-hang the gate. You may hang it on a post, either in the center of the column or at the back corner, or move the gate to the back corner of the columns.
- C. The most difficult solution is to cut a notch in the column to accommodate the operator and power cable. This job is **NOT** for the inexperienced!

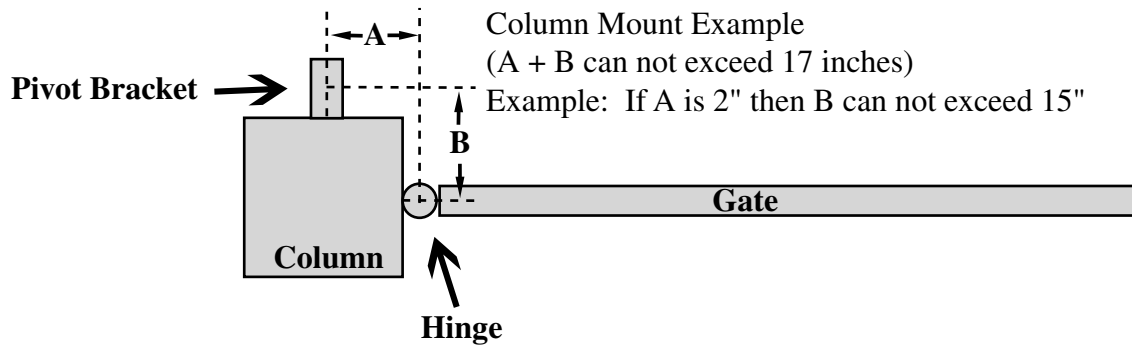



ACCESSORIES

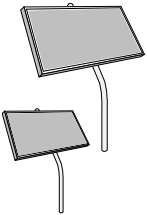

Solar Panel (FM123), (FM122)

The **Solar Panel** is a 10 watt solar powered battery charger for use with the **all GTO/PRO DC** gate operator systems. Particularly suited for remote installations, each **Solar Panel** comes with tubular steel support, mounting clips, wire connectors, and 8 ft. of low voltage wire (see Low Voltage Wire for additional wire). The **GTO/PRO®** control board has clearly labeled terminal connections for easy installation of the **Solar Panel**. Installation in some regions of the world will require multiple solar panels for adequate charging power. **Solar Panel (FM122) is a 5 watt solar powered battery charger with all the same features as (FM123).**



Push Button Control (RB101)

Unlit doorbell button for remote entry or exit control. Wires directly to the control board and uses 16 gauge multi-stranded, dual conductor low voltage wire (sold separately).

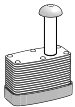

Pin Lock (RB975)

The **Pin Lock** substitutes for the clevis pin at the front end of the **GTO/PRO® 1500** gate operator. Helps prevent theft of the operator from the gate, while allowing quick release of the operator.



Key Chain Mini Transmitter (RB744)

The Key Chain Mini Transmitter is a miniature version of the **GTO/PRO®** entry transmitter and has the same adjustable code settings. 12 Volt battery included.



Entry Transmitter (RB741)

The **GTO/PRO®** entry transmitter, with adjustable code settings, is standard equipment with all **GTO/PRO®** systems. 9 Volt battery included.

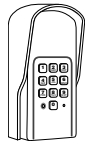

Digital Keypad (F300)

The specially designed digital keypad can be easily installed as a wireless or wired keypad. It can be programmed to use up to fifteen different personal identification number (PIN) codes. Each code is face programmable with additional security features built in. Wired installations require 16 gauge, multi-stranded, dual conductor, direct burial wire (sold separately). Requires 3 AA batteries (not included).

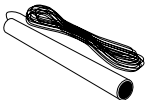

GTO/PRO 50' Exit Wand (FM139), 100' Exit Wand (FM140), 150' Exit Wand (FM141)

The **GTO/PRO®** Exit Wand is designed for residential and agricultural applications and is compatible with all **GTO/PRO®** automatic gate operator models. The wand is an electromagnetic sensor, which offers 'hands free' operation of the **GTO/PRO®** Gate Operators with a 12 ft. radius of detection of vehicles in motion.



Automatic Gate Lock Pull-to-Open (FM144)

A **MUST** for added security. Solenoid driven, with a steel housing. Unlocks and locks automatically as gates open and close. Used with **GTO/PRO®** DC swing gate operating systems for maximum stability and security. Comes with a keyed manual release. Recommended for gates over 8 ft. long. Ideal for animal enclosures or high wind areas.



Wireless Entry Intercom / Keypad (FM136)

Allows owner to screen guest at the gate before allowing access to the property. Keypad also allows owner to give up to 25 programmable entry codes to family, friends or approved delivery personnel. Codes can be permanent or temporary. Can be wireless or hard wired up to 1000 feet.

ACCESSORIES



Replacement Battery (RB500)

Standard 12 volt, 7.0 amp-hour, maintenance-free battery for the **GTO/PRO® 2000**, **GTO/PRO® 3000/3200**, **GTO/PRO® 4000/4200** gate operator systems. This is the only battery approved for use with the **GTO/PRO®** gate operator systems. Life expectancy is 3-5 years.

Low Voltage Wire (RB509)



The 16 gauge, multi-stranded, dual conductor **Low Voltage Wire** is for connecting the AC powered transformer, or the **Solar Panel** to the control board. Also used for the connection of accessories, such as locks, keypads, push buttons and other wired control devices. This specially designed wire is UV treated, PVC coated and ready for direct burial. Available in 1000' rolls or special lengths.

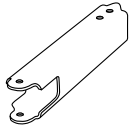

12" Push to Open Bracket (R4KPTO)

An optional longer Post Pivot Bracket for push-to-open installations that need a greater distance to achieve the safe gate and gate operator clearance (2 inches). Order two 12" PTO brackets for conversion of a dual swing gate installation.



Column Mount Lock Receiver (433IH)

For mounting the **Automatic Gate Lock** on brick columns, walls, or for other applications with limited space between gate and post.

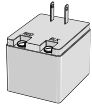

Replacement Transformer (RB570)

Standard 18 volt AC transformer for maintaining the battery included with the **GTO/PRO® 4000/4200** gate operator. This is the only transformer approved for use with **all UL325 GTO/PRO®** gate operator systems.

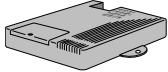

Garage Door Receiver (RB709)

The Garage Door Receiver allows you to use the same **GTO/PRO®** entry transmitter (see Dual and Triple Transmitters) to operate your gate operator and your garage door operator. Compatible with most garage door operators.

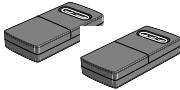

Dual & Triple Button Transmitters (RB742 & RB743)

The Dual (RB742) & Triple (RB743) Button Transmitters are for remote control of multiple separate gate operators, and/or gate operator(s) and garage door operator(s) (see Garage Door Receiver). 9 Volt battery included.

**If you have a question about GTO/PRO accessories
just call 1-800-543-GATE!**

The contents of all material available on this installation manual are copyrighted by GTO, Inc. ("GTO"), unless otherwise indicated. All rights are reserved by GTO, and content may not be reproduced, downloaded, disseminated, published, or transferred in any form or by any means, except with the prior, written permission of GTO. Any reprinting of GTO publications is by permission only. Copyright infringement is a violation of federal law.

GTO®, GTO/PRO®, Bulldog® are registered trademarks of GTO, Inc. Professional Access Systems™ is a trademark of GTO, Inc. and are the exclusive property of GTO, Inc. ("GTO"). All rights are reserved by GTO, and these marks may not be used, in any for without the prior, written permission of GTO.