

Detex Corporation, 302 Detex Drive, New Braunfels, Texas 78130-3045  
(830)629-2900 / 1-800-729-3839 / Fax (830)620-6711  
E-MAIL: detex@detex.com INTERNET: www.detex.com

## INSTALLATION INSTRUCTIONS FOR 90-800

### **FOR INDOOR USE ONLY**

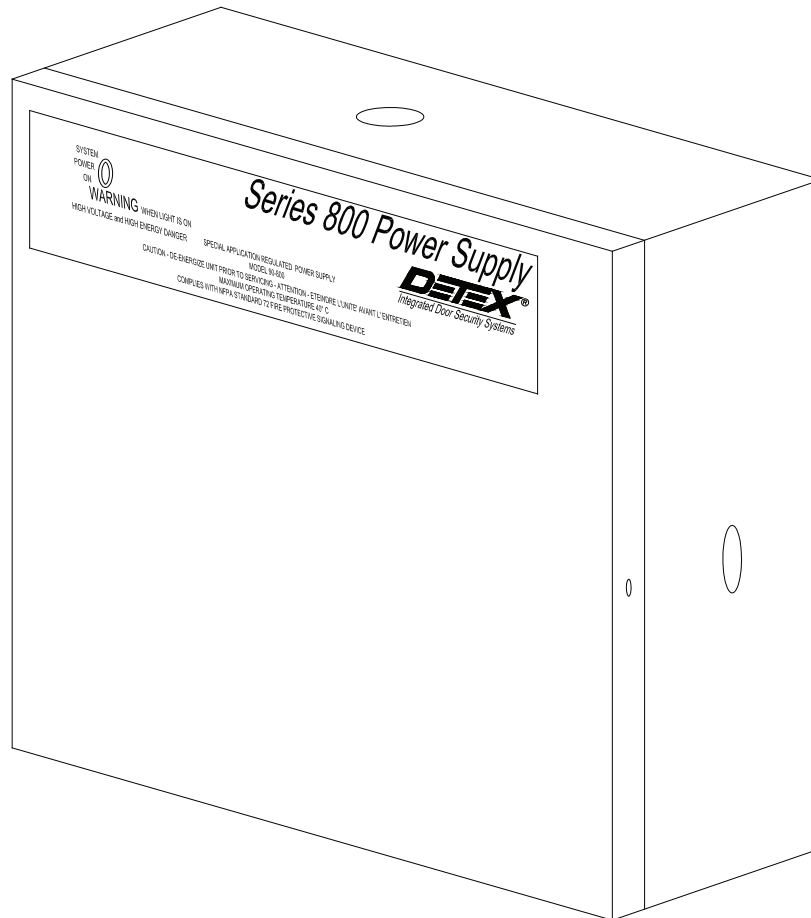

### **Owner's Copy**

90-800 FILTERED AND REGULATED POWER SUPPLY  
1.0 AMP @ 24 VOLTS DC  
INPUT: 120 VAC @ .65A MAX @ 60 Hz.

CAUTION: De-energize unit before servicing.

ATTENTION : éteindre l'unité avant l'entretien.

Enclosure provides protection against electric shock and fire. Do not open without removing power. Only trained personnel should operate or service this equipment.

Le couvercle protège contre les chocs électriques et incendies. Ne pas l'ouvrir sans préalablement couper l'alimentation. Seul le personnel formé doit opérer ou effectuer l'entretien de cet équipement.

# DETEX Model 90-800 Filtered Regulated Power Supply Connection Diagram and Instructions

The 90-800 is a regulated and filtered power supply. It has an output voltage of 24 volts DC.

Refer to the drawing of the power supply (Figure 1) for connections and adjustments. All connections and adjustment should be made with the power supply de-energized **AND** main power switch (item 3) in the OFF position.

Wiring between the fire control panel and fire loop input to this power supply must be configured for fail safe operation.

This unit is intended to operate with door hardware devices. Refer to device instructions for additional details on connections and grounding requirements.

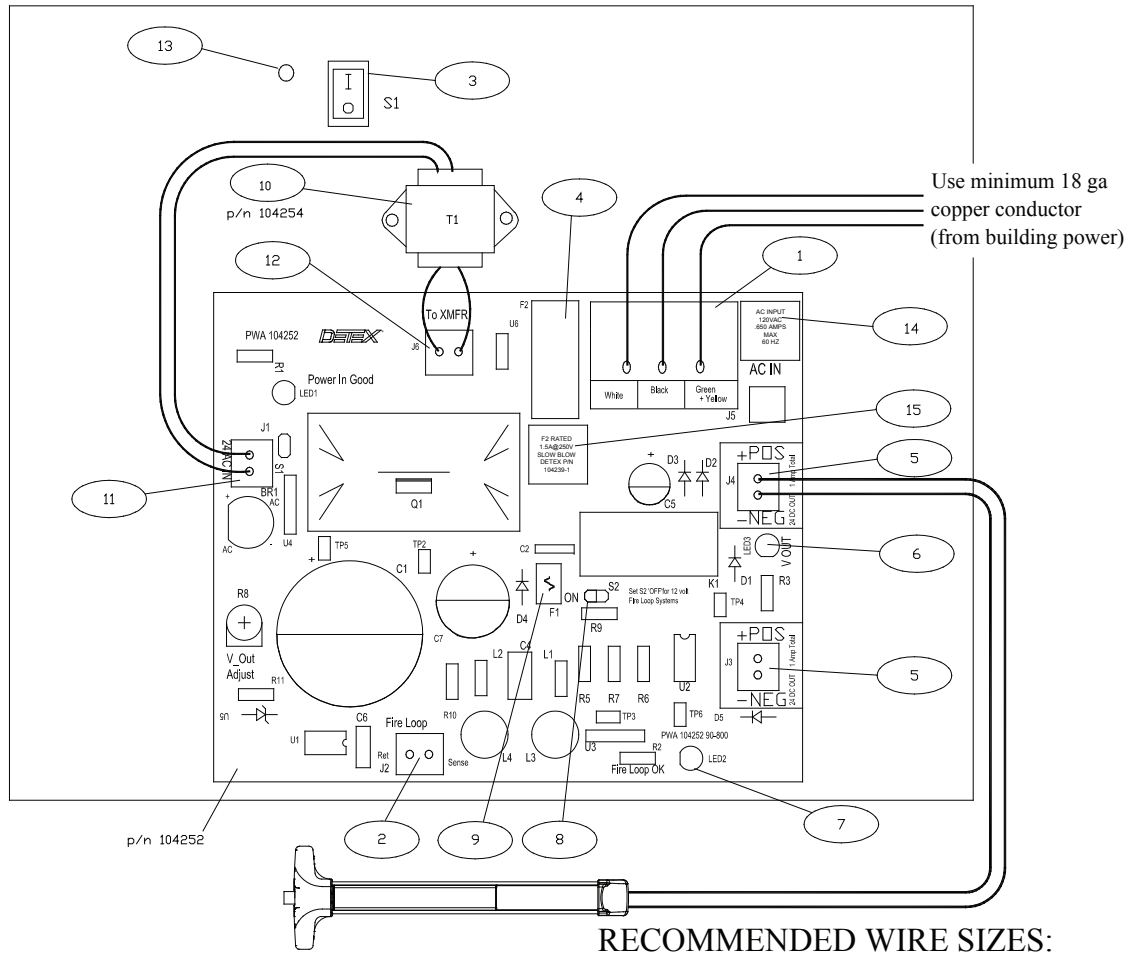
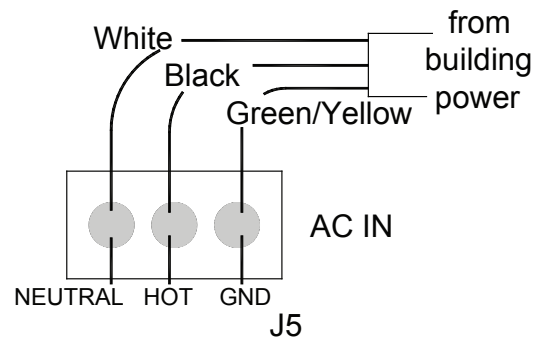

Figure 1.	WIRE GAUGE	MAXIMUM LENGTH OF TWO CONDUCTOR CABLE
	20 AWG	10 FEET
	18 AWG	40 FEET

1: Main Power Connection (J5).

Observe correct terminal connections. Color code requires connections be made per NFPA72. Leave circuit de-energized while installing and servicing unit. Maximum tightening torque: 7 in-lbs (.79 Nm)



2: Fire Loop Control (J2).

The fire loop control requires a connection be made between the Sense and Ret terminals. Some locking devices require this terminal be connected to the building fire system. For independent operation a jumper wire may be used to make the connection. When the connection is made, the power supply outputs 24 volts at J3 and J4. LED 2 will also light when the circuit connection is made (See Item 7). If the circuit is open, the output relay is de-energized and the output of the power supply is turned off. The fire loop terminal is polarity sensitive and has an adjustable sense voltage (See Item 8).

The Ret is connected to the circuit board ground.

**Note: Each power supply should have an independent fire alarm relay.**

Maximum tightening torque: 5.3 in-lbs (.6 Nm)



3: Main ON-OFF Switch (S1).

This switch can be used to de-energize the power supply for service and adjustments. High voltage is still present inside the enclosure (including T1 Item 10) as long as the main power at J5 is still energized. Caution should be used when performing service even when this switch is used.



4: Main Power Fuse (F2).

This is a slow blow fuse and protects the main power into the power supply PWA and transformer. If the fuse fails, check and correct the cause of the overload before replacing with GMT 1.5A fuse.

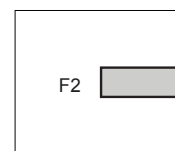

5: Output Terminals (J3, J4).

The power supply outputs 24 volts at a maximum of 1 amp total current. The output is protected by a thermally resettable fuse (F1, Item 9). The output is DC, and the PWA is marked with dual polarity indicators.

Maximum tightening torque: 5.3 in-lbs (.6 Nm)

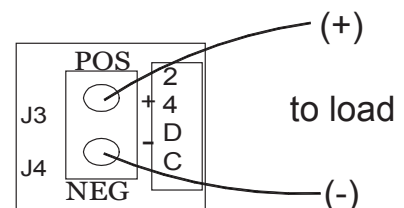

6: Power Output Good (LED 3).

The LED will glow red when the PWA is operating normally and J3 and J4 are energized.

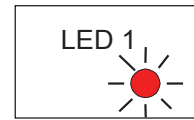

7: Fire Loop Active (LED 2).

The LED will glow red with the Fire Control output terminal is connected correctly.

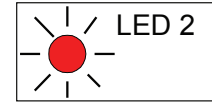

8: Fire Loop Voltage Select (S2).

This switch selects the sense voltage of the fire loop circuit. It is set at the factory to “24”, resulting in a sense voltage of 24 volts. For systems requiring 12 volt sensing, slide the switch to the “12” position.



9: 24 Volt DC Thermal Fuse (F1).

This fuse protects the output of the PWA from overloading. It requires no adjustment and will return to proper operation once the cause of the overload is found and corrected.

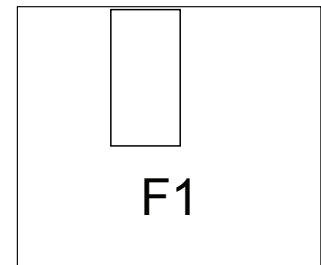

10: Class 2 50 V/A Transformer (T1).

This transformer is supplied by Detex and is rated for proper operation with this power supply. Replace with Detex part number 104254.

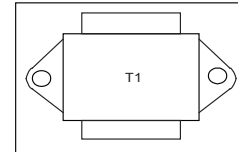

11: 24 Volt AC input (J1) from transformer secondary.

This input is connected at the factory.

Maximum tightening torque: 5.3 in-lbs (.6 Nm)

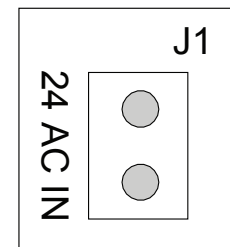

12: Fused high voltage to transformer primary.

This input is connected at the factory. This terminal block has at least 120 VAC live when the AC input at J5 is energized.

Maximum tightening torque: 5.3 in-lbs (.6 Nm)

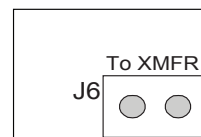

13: LED System Indicator on Front Cover.

This Led glows green when the unit is energized, S1 is 'ON' and the PWA inputs are working normally.

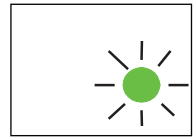

14. AC Input Rating:

This is the required AC power input to this power supply.

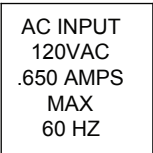

15. Fuse Rating:

Only replace fuse with the type rating specified by this label.

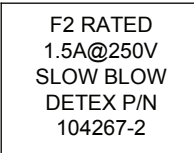

## **90-800 Testing and Trouble Shooting**

1. The green LED on the cover indicates High Voltage is being supplied to the power supply board. If there is no light check F2, replace with same rating and type if blown. Check the load and wiring for proper operation if fuse blows again. Also check incoming power source for disconnect or fault. Make sure S1 is set to 'on'.
2. LED 2 indicates the status of the fire loop connection. This connection must be closed for proper operation. If LED 2 does not light, check the following:
  - a) J2 terminal connection to the building fire system. An Isolation Relay is recommended.
  - b) If an isolation Relay is not used, try reversing the wires on the J2 terminal block. Some building fire systems are polarity sensitive.
  - c) Check S2 for proper fire loop sense voltage. S2 is set to 'ON' at the factory for 24 volt DC sense voltage. Set S2 to 'OFF' for 12 volt sense systems.
  - d) If code does not require this connection, a jumper wire may be placed across the terminals of J2.
3. When the board is powered, LED 3 will light, indicating the 24 volts DC output is active. If LED 3 is not on, first make sure LED's 1 and 2 are both on, following the listed steps above. If they are both on but LED 3 is off, check for a shorted load or wiring to the load. Remove the load from the J3 (and J4) terminal(s), wait 15 - 30 seconds and see if LED 3 comes on. If so, the load or associated wiring has a short. Correct these faults before reconnecting the power supply.
4. Low line voltage: Low input voltage may effect output voltage.
5. Shorted load: A shorted load will cause the output voltage and current to turn off. Locate and correct cause of fault.
6. Enclosure provides protection against electric shock and fire. Do not open without removing power. Disconnect installed at facilities.
7. Only trained personnel should operate or service this equipment.
8. WARNING: When replacing F2 fuse, use ONLY a fuse of the same rating and type.

## **90-800 Maintenance and Spare Parts**

1. Replacement Fuse: Detex number 104267-2
2. Replacement transformer: Detex number 104254
3. Replacement circuit board: Detex number PWA 104252

## Single Page Quick Reference:.

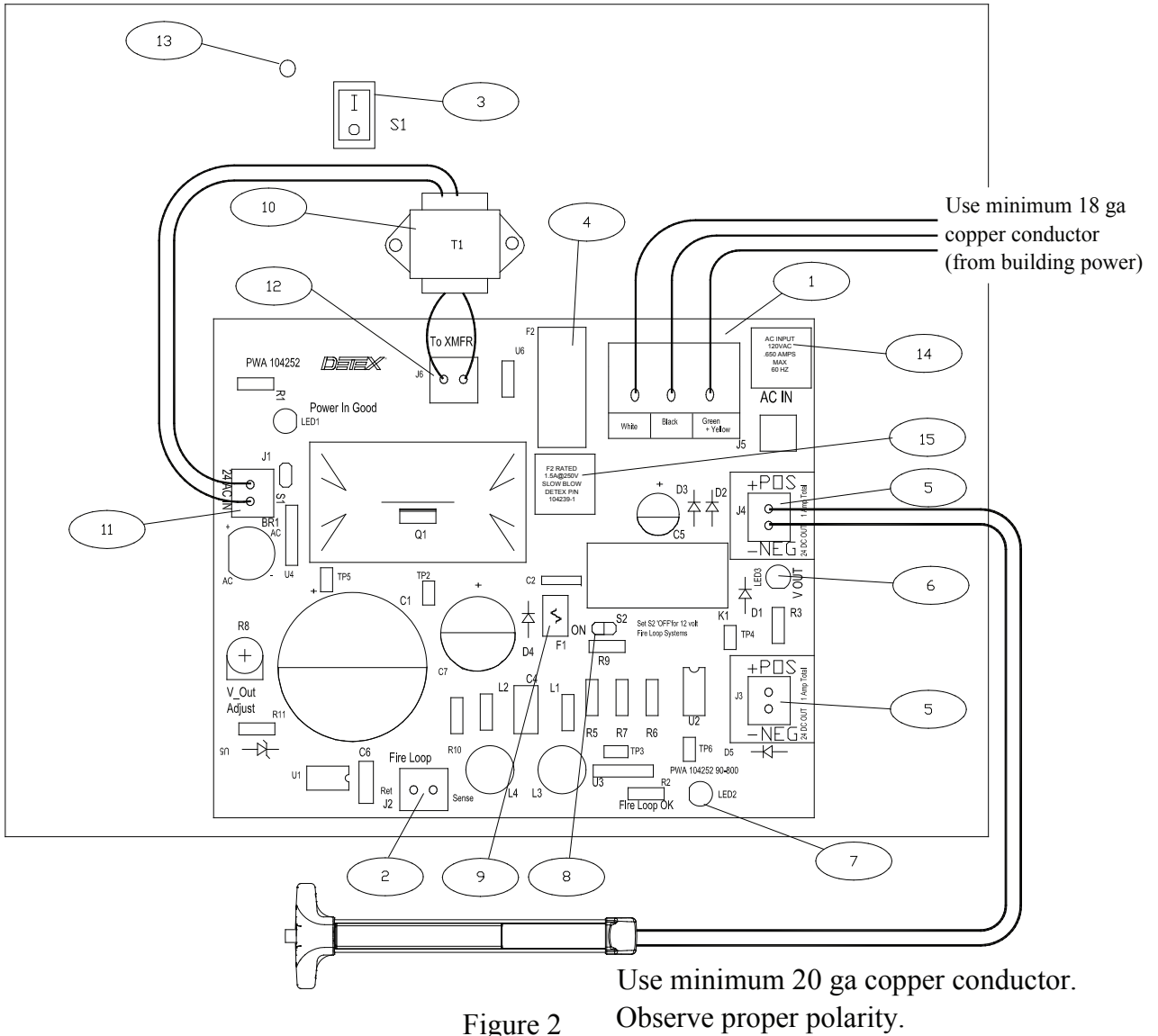

Figure 2

1. AC input.
2. Building fire loop connection.
3. Main On/OFF switch.
4. AC input fuse. See label for rating & type.
5. 24 VDC output connections (x2).
6. DC output active indicator.
7. Fire Loop/Panel connection active.
8. Fire loop sense voltage select. 24 VDC or 12 VDC.
9. PTC resettable output protection fuse.
10. Class 2 transformer. Contact Detex for replacement if needed.
11. 24 VAC input from transformer.
12. Fuse protected AC input to transformer.
13. Power good indicator on front panel of Power Supply.
14. AC input power requirements.
15. Fuse rating

## INSTALLATION 90-800

1. Place box on vertical wall surface - intended use on drywall or concrete block wall. Total top to bottom space required is 10" (255mm). Mark and attach with four #10 screws and #10 nylon conical anchors, minimum length of 1-7/16" for drywall, or equivalent masonry anchors for concrete block wall.
2. Attach conduit and couplings making sure there is still sufficient clearance around the controller board.
3. Connect 120VAC power to Power Supply positions 1, 2 & 3. Insure ground is connected prior to switching power on. Circuit should have breaker or fuse protection equal to 15 ampere. Minimum wire size to be 18 gauge using a minimum torque of 7 in-lbs on the screws.

