



8000 Series Post Mount

Powder Coated Steel

Included Components

- (1) Post Mount
- 4", 5", 6" Poly Block sizes available)
- (1) Leveling Plate
- (4) 3/8"x 1/2" Set Screws
(Post Cap & Trim optional)

Fasteners not included

Recommended Tools

- Safety Glasses
- Tape Measure & Pencil
- Power Drill
- Level
- Circular Saw

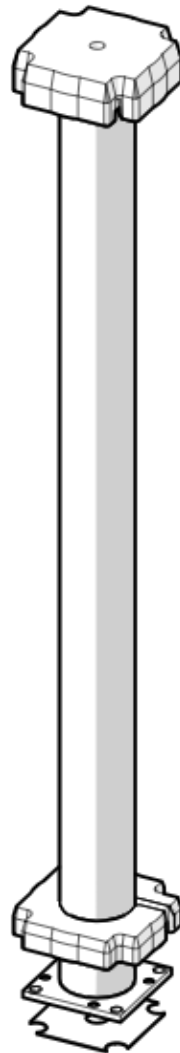

Note: Because building codes vary from one region to another; consult your local building codes to determine acceptable post placement and railing height.

Space Posts according to application and Top Rail length. Place leveling plate (*highlighted*) between Post and mounting surface.

Attach to structural surface using bolts or lags (*not included*). Partially Tighten prior to levelling. Using 3/16" Allen wrench, turn set screws to level post. Then fully tighten structural screws.

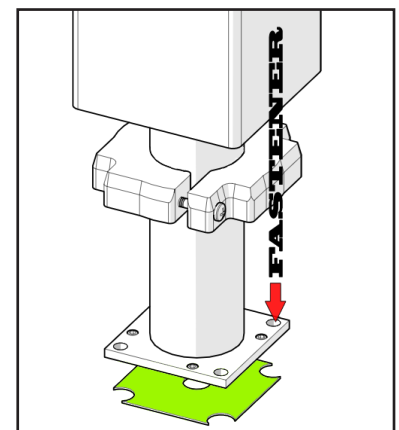

4", 5" & 6" adapter shown

- *These directions are only a guide and may not address every situation.*
- *Always wear proper safety equipment while assembling and installing.*
- *The installer should obtain all required building permits and follow all installation procedures in accordance with applicable building code requirements.*
- *Superior Plastic Products, Inc. shall not be held liable for improper or unsafe installations.*
- *Applying paint, will void your warranty.*
- *To ensure proper coverage by our warranty please visit our website and complete the warranty form and mail to: Superior Plastic Products, Inc., 260 Jalyn Drive, New Holland, PA 17557*

260 Jalyn Drive • New Holland, PA 17557

SuperiorPlasticProducts.com

SPPIG161206