

### GETTING STARTED / INSTALLATION DETAIL

**IMPORTANT:** Read all instructions carefully and completely to ensure proper installation.

**WARNING:** Parts have sharp points & edges. Use extreme caution when handling & installing. Wear safety glasses at all times.

#### Tools & Materials Needed



Safety Glasses



Power screw gun with ratcheting torque setting

#### Step 1

#### INSTALLING THE FIRST BOARD

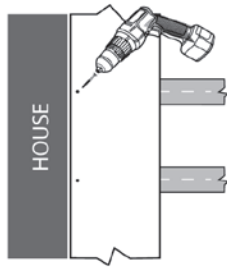

Fasten one edge of the first board at each framing support using Cortex Fasteners for Clubhouse Decking or another brand of quality 2½" (63.5mm) deck screw. It is important that this board is straight and well secured. Allow minimum of ¼" (6.35mm) gap between house and first deck board.

Follow fastener guidelines.

#### Step 3

#### INSTALL FIRST FASTENER



While standing on deck board, install provided screw at 45° angle through fastener and into joist, while applying pressure on fastener. Install one fastener and screw at each support joist.

Make sure fastener body is vertical to deck board and the screw is holding fastener down tight to support joist. Adjust torque setting on screw gun to prevent spin out of the screw head.

#### Step 2

#### POSITION FASTENERS

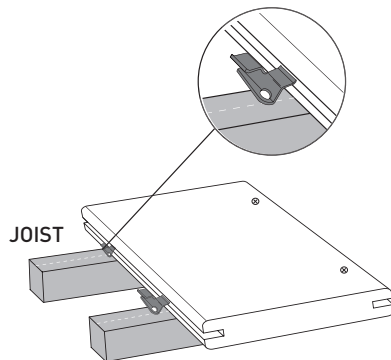

Fully insert Clubhouse Connect Clip fastener into grooved edge of deck board. Screw hole should line up with the center of the support joist.

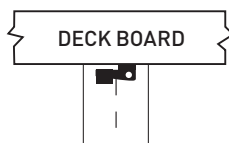

INCORRECT

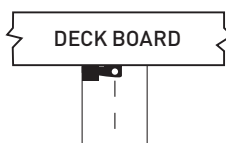

CORRECT

#### Step 4

#### COMPLETING INSTALLATION OF BOARDS

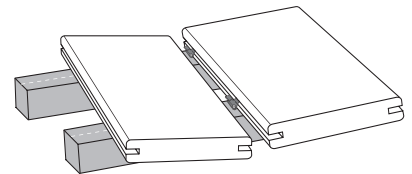

a. Place next deck board into position against fasteners. Slightly raise outer edge of board being installed and slide board onto fasteners until board contacts spacer tabs.

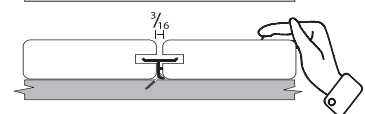

b. Check gap between boards for consistency. Apply force to ensure board is fully installed.

Repeat steps 2 thru 4 until deck is complete.

## HELPFUL TIPS

### Coverage

- Multiply the number of joists by the number of deck boards to equal the number of fasteners needed.
- 90 fasteners will cover approximately 50 sq. ft. (4.6 m<sup>2</sup>) using 5.25" (133mm) decking boards on 16" (410mm) centers.

### How do you attach the last board?

To finish, we recommend using Cortex Fasteners for Clubhouse Decking or another brand of quality 2½" (63.5mm) deck screws to secure the last board along its edge. Pre-drill and countersink all deck screws. Pre-drill/screw should be a minimum of 1" (25mm) from edge of deck board.

### 45° angle installation

When deck is in the walled corner of the house, always start with small piece of decking in that corner and work your way out. **When installing Connect Clip fasteners**, off set the center ½" (13mm) towards the long point of joist, so screw will not exit side of joist when driven.

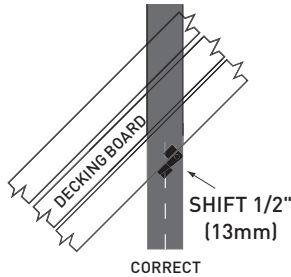

### How to do a butt seam

First, install a small framing board 10–12" (250–300mm) along side the joist on which the seam is going to land. Install additional fastener into previous board above small framing block. Line up your first board in the center of the joist and the small framing board. Install a fastener and screw at each joist of the first board including the joist at the seam. Then install your second board in the same fashion, and place a second fastener at the seam attaching it to the small framing block. Be sure you follow the end-to-end gapping instructions provided by decking manufacturer.

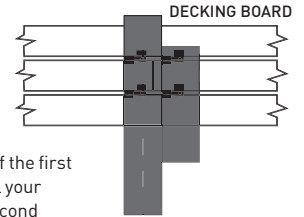

### How to replace a board

- Make two parallel cuts down the center of the board to be replaced, and remove the center piece.
- Using a small pry bar, remove the remaining pieces of decking from the tabs.
- Using a reciprocating saw, remove the tabs on the side of the board with the screw heads showing.
- Position new board into place, and carefully slide onto remaining tabs.
- Once board is set into position, secure the lead edge with Cortex Fasteners for Clubhouse Decking or another brand of quality 2½" (63.5mm) deck screws.

## ADDITIONAL PRODUCTS AVAILABLE:

**Tiger Claw Installation Gun:** A light weight semi-automatic installation tool for use with Connect Clip fasteners.

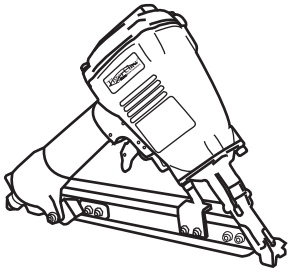

Gun package includes: Installation gun, case, hose fitting, safety glasses, spare parts kit, installation video, complete installation instructions.

### Benefits:

- Lifetime warranty from Tiger Claw, Inc.
- Double safety trigger
- Angled nose for easier use
- Redesigned magazine for better collation control
- Reduced installation time
- Reduced labor costs
- Increased productivity

**TC-SG:** Collated Pneumatic Screws packaged and used specifically with the Tiger Claw Installation Gun.

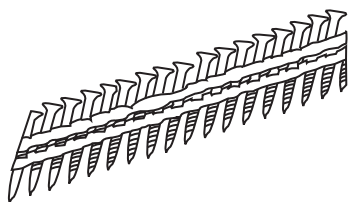

C-1018 / 1022 Coated steel collated pneumatic screws for use with the Tiger Claw Installation Gun. Screws are approved for use on ACQ.

### Benefits:

- Installs Connect Clip fasteners faster than conventional "screw gun" installation
  - Easily installed, quickly removable
  - Save time and labor costs
- 1 box covers approximately 500 sq. ft.

**Cortex Hidden Fastening System:** Screws, plugs and setting tools for hidden face fastening of Clubhouse Decking.

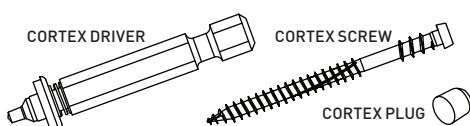

### Benefits:

- Hidden fasteners for stairs, perimeter boards and more
- Color matched for Clubhouse Decking
- No pre-drilling needed
- Highest level of fastening strength
- Setting tool ensures correct depth