

DOUBLE MAINE BOARD RAIL GATE (4 FOOT & 8 FOOT WIDE 46" HIGH GATES) REAR EYE HINGES (Product Codes #8324) GATE HUNG BETWEEN POSTS

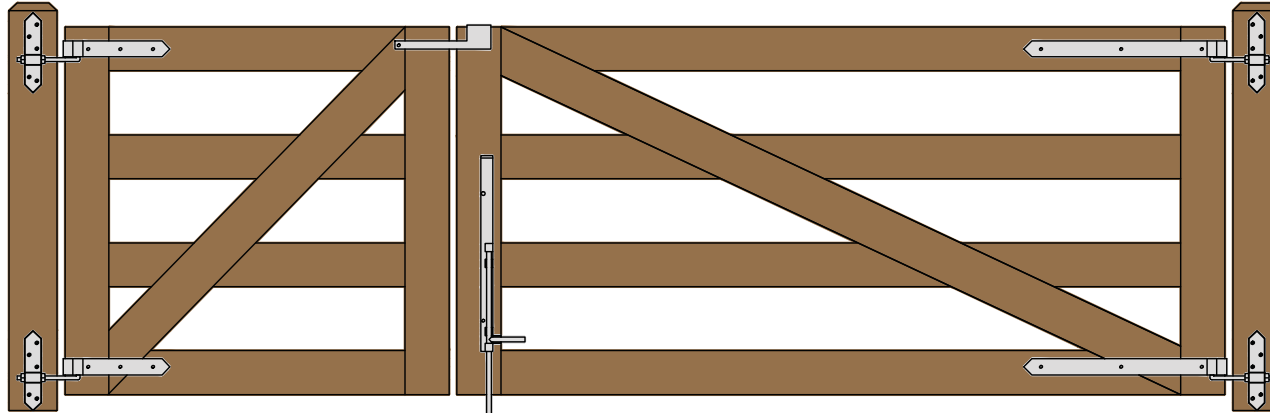

Distance between gate and hinge post	A
Width of Left Gate	B
Distance between gates	C
Width of Right Gate	D
Distance between gate and hinge post	E
Total distance between posts	F

Hardware Required		Rear Eye Hinge Advantages	
	Galvanized Finish	Black Powder Coat over Galvanized Finish	Opens 180 degrees Incredible amount of adjustment Easy operation & Very Strong Minimal distance between gate and post
Hinge Sets	1 of 8324-122 & 1 of 8324-S242	1 of 8324-12P and 1 of 8324-S24P	
fasteners included with hardware	Two Sets Includes two 12" double strap (8324-122 or 8324-12SP) & two 24" double strap (8324-242 or 8324-24SP) four mounting plate with 8" adjustable threaded pins(8256-342 or 8256-34P)		
Cane Bolt (Vertical)	1 or 2 of 5000-242*	1 or 2 of 5000-24SP*	
Central Latch Options			Dimensions (feet and inches)
			A B C D E F
Throw Over Gate Loop	4200-032	4200-03SP	1" 4' 1" 8' 1" 12' 3"
Cane Bolt and Keep	5000-122 plus 5000-002	5000-12SP plus 5000-00SP	1" 4' 1" 8' 1" 12' 3"
Lumber Required			
Posts	2 of 8' x 6" x 6" (usually dressed out at 5.5" x 5.5")		
Rails, Stiles (uprights) and Diagonals made from full 1" thick by 5.5" wide lumber (commonly stocked decking material or rough cut lumber)			
Rails	3 of 8' x 1" x 5.5" and 6 of 8' x 1" x 5.5"		
Stiles	4 of 8' x 1" x 5.5"		
Diagonals	1 of 10' x 1" x 5.5" and 2 of 8' x 1" x 5.5"		
Filler blocks for bottom hinge	1 of 8' x 1" x 5.5"		
Fasteners Required			
Approximately 100 of 1.75" x #8 wood screws (stainless preferred)			
24 of 3.5" x 3/8" carriage bolts (hot dipped galvanized or stainless steel), nuts, and washers			
Mounting Plate Fasteners - 20 of 3/8" carriage bolts that are 1" longer than thickness of gate post (preferred) or 20 of 3/8" lag bolts (minimum of 4" long)			
*One 24" Cane Bolt (5000-242 or 5000-24SP) is required for central stability. Two are needed if you require a means of keeping the gates open.			

Hoover Fence Company

Download includes this materials list, component cutting and layout sheet, tips on installing gate posts, and detailed instructions.

For a complete listing of our free gate plans and gate layouts visit hooverfence.com.

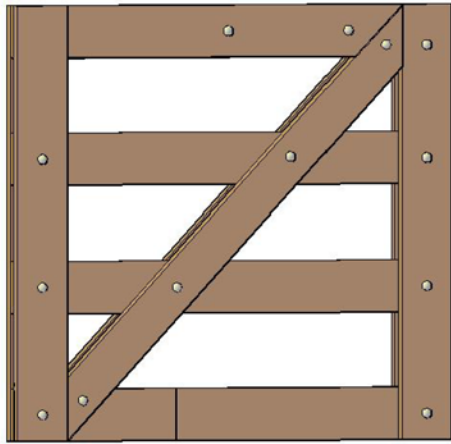

FLAT FRONTAL VIEW

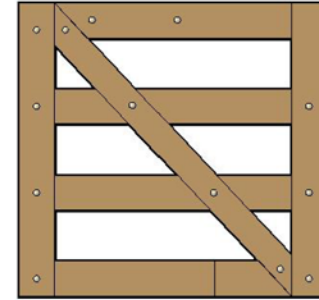

THREE LAYERS

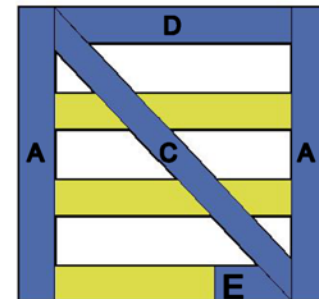
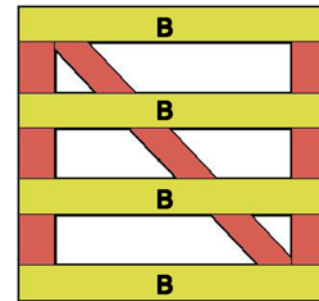
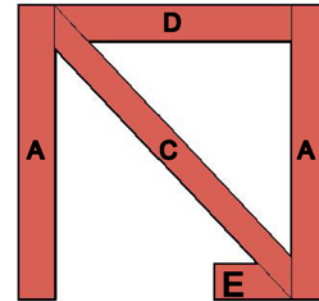

COMPONENTS (FULL 1" THICK x 5-1/2" WIDE)

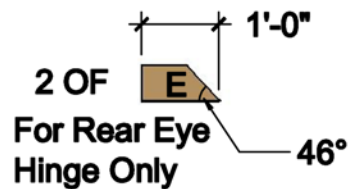
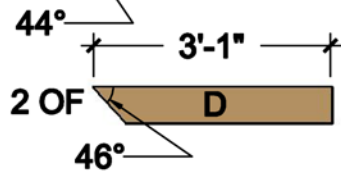
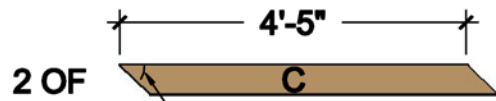
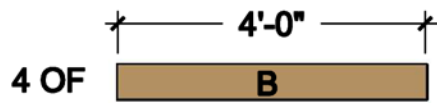
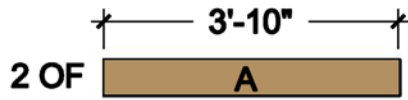

**Hoover Fence
4' Maine Board Gate**

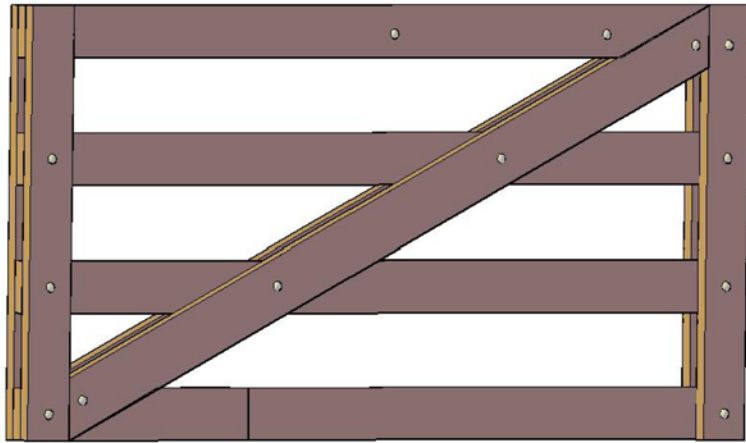

FLAT FRONTAL VIEW

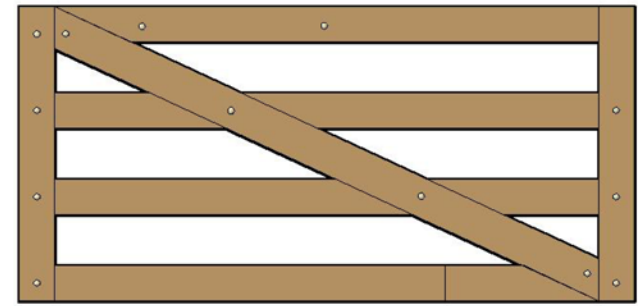

COMPONENTS (FULL 1" THICK x 5-1/2" WIDE)

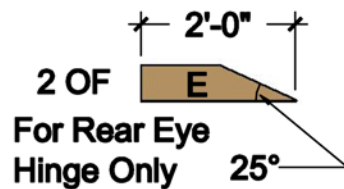
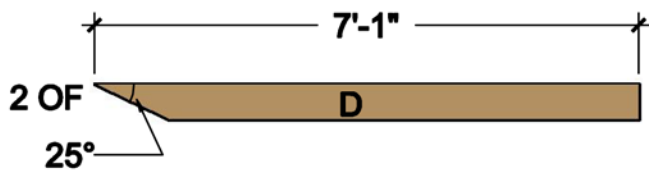
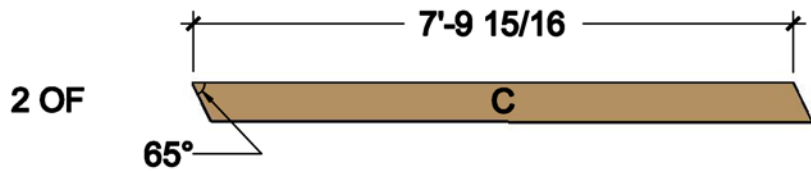
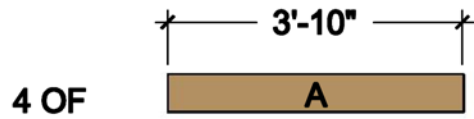

THREE LAYERS

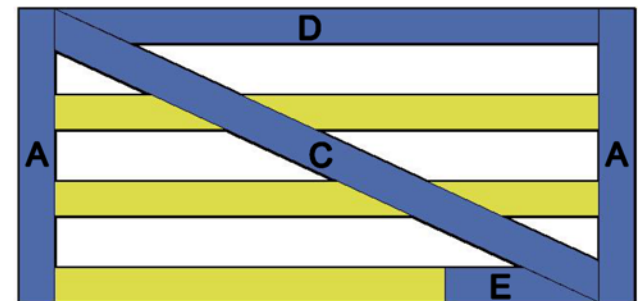
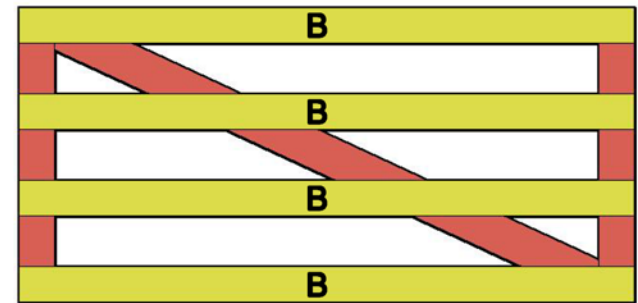
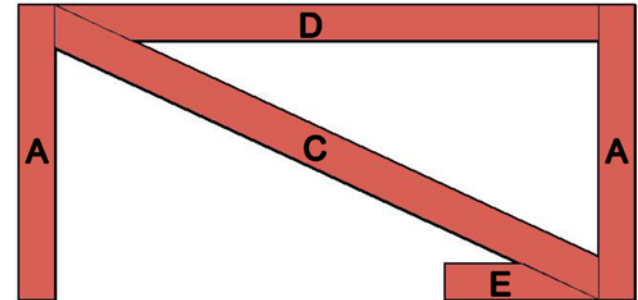

Hoover Fence Company
8' Maine Board Gate