

MONTAGE[®]



RESIDENTIAL ORNAMENTAL STEEL FENCE



Montage ornamental steel fence is *unparalleled in strength* and quality, *adapts to virtually any terrain, withstands vast shifts in climate* yet remains untouched by time in stately elegance. This fence offers an *array of unique options* to fit your specific sense of style and application.



PRIMARY APPLICATIONS

- *Single Family Residence*
- *Apartments (Multi-Family)*
- *Subdivisions*
- *Golf Courses*

MONTAGE®

RESIDENTIAL ORNAMENTAL STEEL FENCE

.590"sq x 18ga PICKETS | .9375" x 1.25" x 14ga RAILS | 2"sq x 16ga POSTS

Each picket is precisely welded at each rail intersection providing all-terrain flexibility and aesthetics.

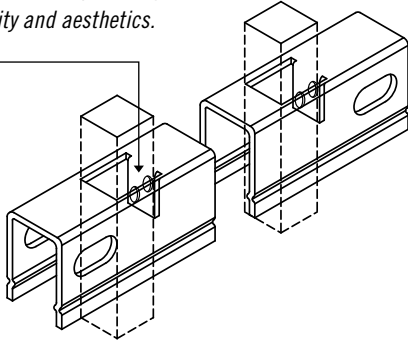

STYLE OPTIONS



Also available in Pool, Pet & Play (3" air spacing) – styles vary

PROFUSION WELDED STEEL



All Montage fence panels are fabricated using Ameristar's ProFusion welding process. This technique combines laser and fusion technology to create a virtually invisible structural connection at every picket to rail intersection. Unlike typical aluminum fence systems that are held together with unsightly screws, the ProFusion weld used with Montage promotes a "good neighbor" profile with sleek lines and no exposed picket to rail fasteners. When compared to aluminum fencing, Montage's welded steel construction is unmatched in strength and durability.



E-COAT™ PROTECTIVE FINISH

Montage galvanized steel framework is subjected to a multi-stage pre-treatment/wash (with zinc phosphate), followed by a duplex cathodic electrocoat system consisting of an epoxy primer, which significantly increases corrosion protection, and an acrylic topcoat, which provides the protection necessary to withstand adverse weathering effects. This process results in years of maintenance-free ownership.



20 YEAR LIMITED WARRANTY

The Montage families of fencing products are manufactured from superior quality materials by skilled craftsmen with the highest standards of workmanship in the industry. Ameristar is confident in offering Montage with a 20 year limited warranty.



DOMESTIC MANUFACTURING

Ameristar is committed to providing products that are manufactured in the USA. We have made significant investments in technology, process improvement, and employee training in an effort to secure American jobs and combat inferior import products.

MONTAGE® | 2 & 3-RAIL OPTIONS | 3" & 4" AIR-SPACE OPTIONS

STANDARD BOTTOM & FLUSH BOTTOM OPTIONS AVAILABLE

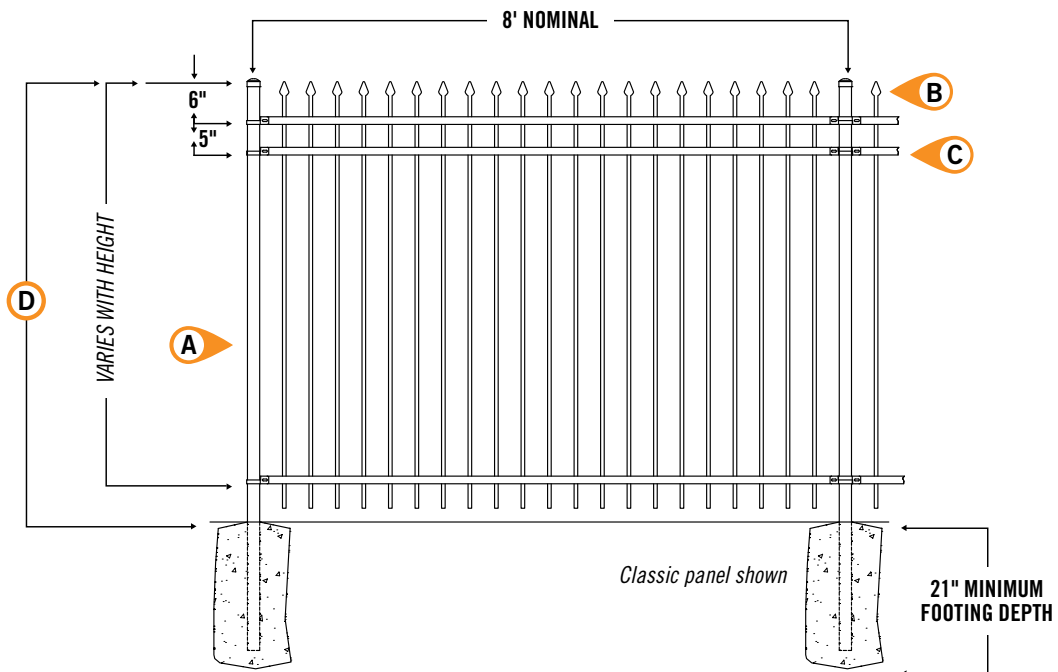

- Ⓐ 2"sq x 16ga POSTS
- Ⓑ 0.590"sq x 18ga PICKETS
- Ⓒ 0.9375"w x 1.25"h x 14ga RAILS
- Ⓓ 3', 3.5', 4', 4.5', 5' & 6' PANEL HEIGHTS

Refer to construction specification & tables within this section for recommended post space by bracket type

Effective: 01/01/14

MONTAGE® | 2-RAIL PANELS | 4" AIR GAP

STANDARD BOTTOM | 8' PANEL LENGTH (94" actual width) | 21 PICKETS PER PANEL | 40 PANELS PER PALLET

PANEL	ITEM NUMBER	WEIGHT	STOCKING
3'	R☒⊗234	30 lbs	MB
3.5'	R☒⊗240	33 lbs	MB
4'	R☒⊗246	36 lbs	CB MB GB MN
5'	R☒⊗258	43 lbs	CB MB GB

☒ = FENCE STYLES AVAILABLE | **C** = Classic **M** = Majestic **G** = Genesis
W = Warrior **L** = Crescent*

⊗ = COLOR OPTIONS AVAILABLE | **B** = Black **N** = Bronze

⊙ = NON-STOCKED PRODUCT

For details, see Ameristar's Sales Policy in the catalog guide.

Notes: Genesis panels are packaged with BLACK picket plugs for black & bronze.

* Not Rackable panels.

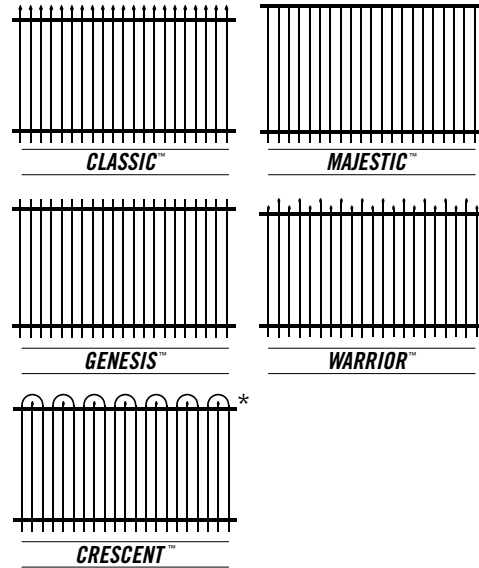

MONTAGE® | 2-RAIL PANELS | 3" AIR GAP

STANDARD BOTTOM | 8' PANEL LENGTH (94" actual width) | 26 PICKETS PER PANEL | 40 PANELS PER PALLET

PANEL	ITEM NUMBER	WEIGHT	STOCKING
3'	R☒⊗234-3	34 lbs	⊙
3.5'	R☒⊗240-3	38 lbs	⊙
4'	R☒⊗246-3	44 lbs	⊙

☒ = FENCE STYLES AVAILABLE | **M** = Majestic **H** = Gemini

⊗ = COLOR OPTIONS AVAILABLE | **B** = Black **N** = Bronze

⊙ = NON-STOCKED PRODUCT

For details, see Ameristar's Sales Policy in the catalog guide.

* Not Rackable panels.

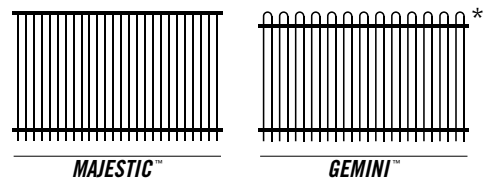

MONTAGE® | 2-RAIL PANELS | 4" AIR GAP

FLUSH BOTTOM | 8' PANEL LENGTH (94" actual width) | 21 PICKETS PER PANEL | 40 PANELS PER PALLET

PANEL	ITEM NUMBER	WEIGHT	STOCKING
3'	R☒⊗234F	30 lbs	<u>MB</u>
3.5'	R☒⊗240F	33 lbs	<u>MB</u>
4'	R☒⊗246F	36 lbs	<u>MB</u>
5'	R☒⊗258F	43 lbs	<u>MB</u>

☒ = FENCE STYLES AVAILABLE | C = Classic M = Majestic G = Genesis
W = Warrior L = Crescent*

⊗ = COLOR OPTIONS AVAILABLE | B = Black N = Bronze

⊙ = NON-STOCKED PRODUCT

For details, see Ameristar's Sales Policy in the catalog guide.

Notes: Genesis panels are packaged with BLACK picket plugs for black & bronze.

* Not Rackable panels.

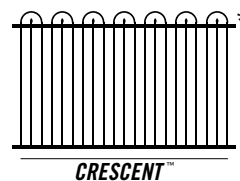
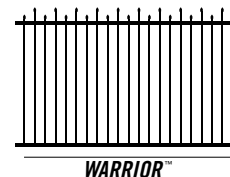
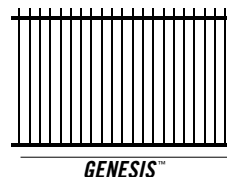
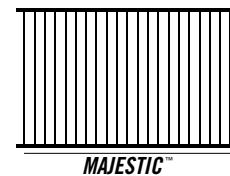
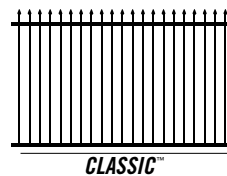

MONTAGE® | 2-RAIL PANELS | 3" AIR GAP

FLUSH BOTTOM | 8' PANEL LENGTH (94" actual width) | 26 PICKETS PER PANEL | 40 PANELS PER PALLET

PANEL	ITEM NUMBER	WEIGHT	STOCKING
3'	R☒⊗234F-3	34 lbs	⊙
3.5'	R☒⊗240F-3	38 lbs	⊙
4'	R☒⊗246F-3	44 lbs	<u>MB</u>

☒ = FENCE STYLES AVAILABLE | M = Majestic H = Gemini

⊗ = COLOR OPTIONS AVAILABLE | B = Black N = Bronze

⊙ = NON-STOCKED PRODUCT

For details, see Ameristar's Sales Policy in the catalog guide.

* Not Rackable panels.

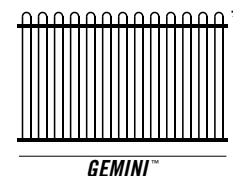
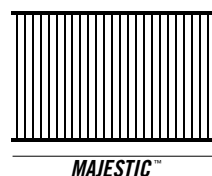

Effective: 01/01/14

MONTAGE® | 3-RAIL PANELS | 4" AIR GAP

STANDARD BOTTOM | 8' PANEL LENGTH (94" actual width) | 21 PICKETS PER PANEL | 40 PANELS PER PALLET

PANEL	ITEM NUMBER	WEIGHT	STOCKING
3'	R☒☒334	35 lbs	CB MB GB
3.5'	R☒☒340	39 lbs	CB MB GB
4'	R☒☒346	42 lbs	CB MB GB WB LB MN
5'	R☒☒358	49 lbs	CB MB GB WB GN
6'	R☒☒370	55 lbs	CB MB GB WB CN

☒ = FENCE STYLES AVAILABLE | **C** = Classic **M** = Majestic **G** = Genesis
W = Warrior **L** = Crescent*

☒ = COLOR OPTIONS AVAILABLE | **B** = Black **N** = Bronze

⊙ = NON-STOCKED PRODUCT

For details, see Ameristar's Sales Policy in the catalog guide.

Notes: Genesis panels are packaged with BLACK picket plugs for black & bronze.

* Not Rackable panels.

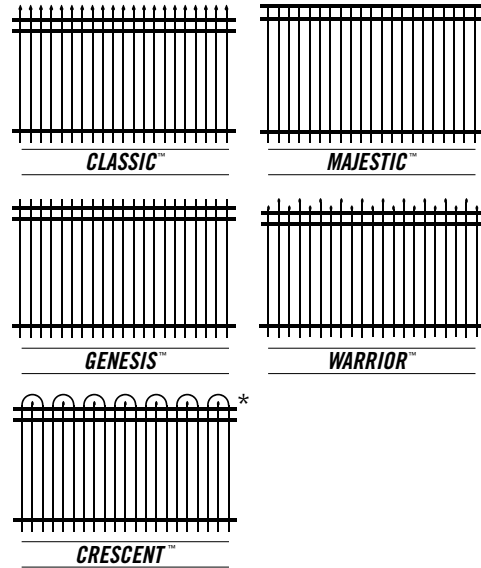

MONTAGE® | 3-RAIL PANELS | 3" AIR GAP

STANDARD BOTTOM | 8' PANEL LENGTH (94" actual width) | 26 PICKETS PER PANEL | 40 PANELS PER PALLET

PANEL	ITEM NUMBER	WEIGHT	STOCKING
3'	R☒☒334-3	40 lbs	⊙
3.5'	R☒☒340-3	44 lbs	⊙
4'	R☒☒346-3	50 lbs	CB MB GB
5'	R☒☒358-3	55 lbs	CB MB
6'	R☒☒370-3	62 lbs	CB MB

☒ = FENCE STYLES AVAILABLE | **C** = Classic **M** = Majestic **G** = Genesis
H = Gemini *

☒ = COLOR OPTIONS AVAILABLE | **B** = Black **N** = Bronze

⊙ = NON-STOCKED PRODUCT

For details, see Ameristar's Sales Policy in the catalog guide.

* Not Rackable panels.

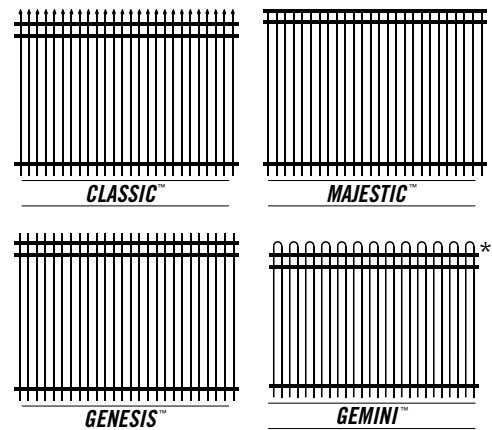

MONTAGE® | 3-RAIL PANELS | 4" AIR GAP

FLUSH BOTTOM | 8' PANEL LENGTH (94" actual width) | 21 PICKETS PER PANEL | 40 PANELS PER PALLET

PANEL	ITEM NUMBER	WEIGHT	STOCKING
3'	R☒☒334F	35 lbs	MB
3.5'	R☒☒340F	39 lbs	MB
4'	R☒☒346F	42 lbs	MB
4.5'	RM☒354F	48 lbs	MB
5'	R☒☒358F	49 lbs	CB MB GB
6'	R☒☒370F	55 lbs	MB

☒ = FENCE STYLES AVAILABLE | **C** = Classic **M** = Majestic **G** = Genesis
W = Warrior **L** = Crescent*

☒ = COLOR OPTIONS AVAILABLE | **B** = Black **N** = Bronze

⊙ = NON-STOCKED PRODUCT
 For details, see Ameristar's Sales Policy in the catalog guide.

Notes: Genesis panels are packaged with BLACK picket plugs for black & bronze.
 * Not Rackable panels.

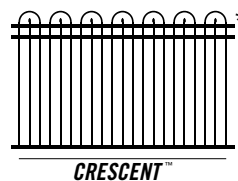
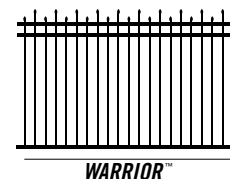
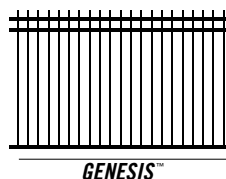
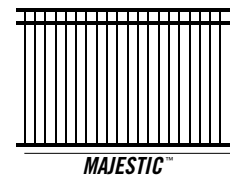
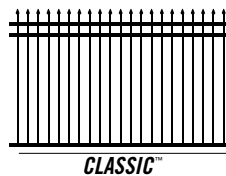

MONTAGE® | 3-RAIL PANELS | 3" AIR GAP

FLUSH BOTTOM | 8' PANEL LENGTH (94" actual width) | 26 PICKETS PER PANEL | 40 PANELS PER PALLET

PANEL	ITEM NUMBER	WEIGHT	STOCKING
3'	R☒☒334F-3	40 lbs	⊙
3.5'	R☒☒340F-3	44 lbs	⊙
4'	R☒☒346F-3	50 lbs	MB
4.5'	RM☒354F-3	55 lbs	⊙
5'	R☒☒358F-3	56 lbs	⊙
6'	R☒☒370F-3	63 lbs	⊙

☒ = FENCE STYLES AVAILABLE | **C** = Classic **M** = Majestic **G** = Genesis
H = Gemini *

☒ = COLOR OPTIONS AVAILABLE | **B** = Black **N** = Bronze

⊙ = NON-STOCKED PRODUCT
 For details, see Ameristar's Sales Policy in the catalog guide.

* Not Rackable panels.

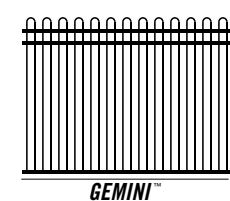
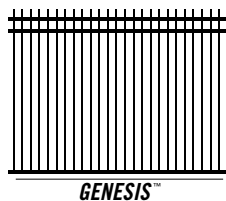
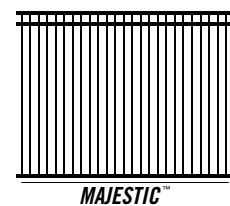
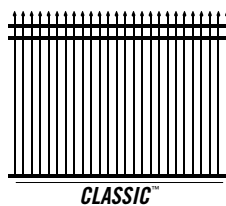

MONTAGE® | BRACKETS

AVAILABLE IN BAG QUANTITIES ONLY

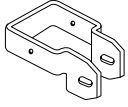

DESCRIPTION	ITEM NUMBER	BAG QTY	BOX QTY	WEIGHT
Universal Boulevard Bracket	B⊗102	2	150	.27 lbs
<i>Bags packaged with: #10 x .75" self-drilling screws .25" x 1.5" carriage bolts .25" flange nuts</i>				

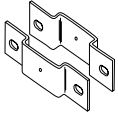

Line Bracket	B⊗104	2	120	.47 lbs
<i>Bags packaged with: #10 x .75" self-drilling screws .25" x 1.5" carriage bolts .25" flange nuts Use as a Boulevard Bracket around a 2" post to join two adjacent fence panels in-line.</i>				

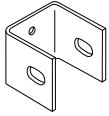

Flat Mount Bracket	B⊗105	2	300	.15 lbs
<i>Bags packaged with: #14 x .75" self-drilling screws .25" x 1.5" carriage bolts .25" flange nuts Use to attach fence panels to walls, wood posts, etc.</i>				

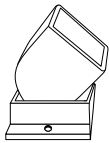

Swivel Bracket	B⊗106	2	120	.20 lbs
<i>Bags packaged with: #10 x .75" self-drilling screws #10 x .625" flat head Phillips screw. Use for oblique angle intersections.</i>				

⊗ = COLOR OPTIONS AVAILABLE | B = Black N = Bronze

MONTAGE® | FINIALS & ADORNMENTS

FINIALS & PICKET PLUGS FOR GENESIS PANELS ONLY



QUAD FLARE
.590" / .2 lbs
A⊗301



TRIAD
.590" / .2 lbs
A⊗302



ROYALTY
.590" / .2 lbs
A⊗303

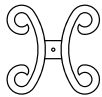

BUTTERFLY SCROLL
.590" / .2 lbs
H⊗058



DOUBLE RINGS
.590" / .7 lbs
A⊗102

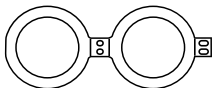

CORONA
.590" / .35 lbs
A⊗103*



SERPENTINE SCROLL
.590" / .75 lbs
H⊗059

.590" PRESS FIT PICKET FINIALS

» 21 finials required per panel with 4" air-space

» 26 finials required per panel with a 3" air-space

* Picket plugs in bag quantities only / 21 plugs per bag

⊗ = COLOR OPTIONS AVAILABLE | B = Black N = Bronze

NOTE: Picket plugs are available in bag quantities only / 21 plugs per bag. Item number = AB502

MONTAGE PANEL ADORNMENTS

» Fit in between / on the face of top rails on 3-rail panels

» #10 x .75" self-drilling screws included

» 11 adornments required per panel





» Die cast aluminum / Corona pressed steel*

⊗ = COLOR OPTIONS AVAILABLE | B = Black N = Bronze

Effective: 01/01/14

MONTAGE® | FASTENERS

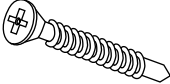
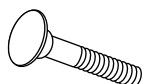
AVAILABLE IN BAG QUANTITIES ONLY (Phillips head screws sold individually)

	DESCRIPTION	ITEM NUMBER / BLACK	ITEM NUMBER / BRONZE	BAG QTY
	#14 x .75" Self-Drilling Screws <i>Steel hex head self-drilling screws for attaching Montage brackets & adornments</i>	1-0004-1P-50	HN524P	50
	#10 x .75" Self-Drilling Screws <i>Steel hex head self-drilling screws for attaching Montage brackets & adornments</i>	1-0002-1P-50	HN539P	50
	#10 x .625" Phillips Head Screws <i>Steel flat head screws for setting angle on Montage swivel brackets</i>	HB519P	n/a	n/a
	.25" x 1.5" Carriage Bolts <i>Steel carriage bolts for Montage brackets</i>	2-0001-1P-20	HN511P	20
	.25" Flange Nuts <i>Steel flange nuts for attaching Montage brackets</i>	3-0001-1P-20	HN541P	20

COLOR OPTIONS AVAILABLE | **B** = Black **N** = Bronze

MONTAGE® | CUSTOM FINISHES

WARRANTY ON CUT COMPONENTS VOID WITHOUT PROPER TOUCH-UP APPLICATION*

*For details & the guidelines for the proper 3-step process, see Ameristar's Sales Policy in the catalog guide

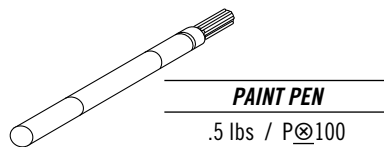

⊗ = COLOR OPTIONS AVAILABLE | **B** = Black **N** = Bronze

Effective: 01/01/14

MONTAGE® | POSTS, BASES & CAPS

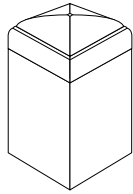

STEEL POSTS

2"sq. x 16ga.

2.5"sq. x 16ga.

POST LENGTH	ITEM NUMBER	WEIGHT
4' 9"	WP⊗ 20057	8 lbs
5' 3"	WP⊗ 20063	9 lbs
5' 9"	WP⊗ 20069	10 lbs
6' 9"	WP⊗ 20081	11 lbs
7' 9"	WP⊗ 20093	13 lbs
8' 9"	WP⊗ 20105	14 lbs
6'	WP⊗ 25072	12 lbs
7'	WP⊗ 25084	14 lbs
8'	WP⊗ 25096	16 lbs
9'	WP⊗ 25108	18 lbs

NOTE: When installed in locations subject to freezing temperatures, where posts are grouted into core-drilled holes, a .25" hole must be drilled into the post approximately .5" above the elevation. This allows for proper drainage of ground water build-up. The drilled hole must be clean & dry prior to applying zinc primer & color finish. Failure to follow these practices voids the warranty of the fence system.

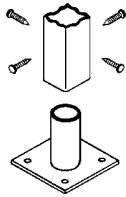

POST BASE

Fits 2"sq post

BASE SIZE	ITEM NUMBER	DRILL HOLES	WEIGHT
5" x 5"	B⊗ 205	.5625"	3 lbs

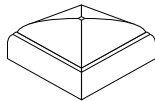

STANDARD FLAT CAP

Steel

CAP SIZE	ITEM NUMBER	WEIGHT
1.75"sq.	A⊗ 505	.1 lbs
2"sq.	A⊗ 506	.2 lbs
2.5"sq.	A⊗ 507	.3 lbs



BALL CAP

Aluminum

CAP SIZE	ITEM NUMBER	WEIGHT
2"sq.	H⊗ 508R	.7 lbs
2.5"sq.	A⊗ 513	.7 lbs

⊗ = **COLOR OPTIONS AVAILABLE** | **B** = Black | **N** = Bronze | **W** = White
S = Sand

Effective: 01/01/14

MONTAGE® | LIMITED WARRANTY

WELDED ORNAMENTAL FENCE

Ameristar's Montage® welded ornamental fences are manufactured from the highest quality materials by skilled craftsmen to meet the highest standards of workmanship in the industry. Galvanized steel framework is subjected to a multi-stage pretreatment/wash (*with zinc phosphate*), followed by a duplex cathodic electro-coat system consisting of an epoxy primer, which significantly increases corrosion protection, and an acrylic liquid topcoat, which provides the protection necessary to withstand adverse weathering effects.

The electro-coated surface on all Montage welded ornamental panels and posts are guaranteed under normal and intended usage, against cracking, peeling, chipping, blistering or corroding commencing with the original purchase date and extending according to the applications defined in the table below. Normal and intended usage does not include physical damage, abrasion, or heavy salt spray exposure to the protective coating.

THE FOLLOWING ACTS AND/OR OMISSIONS WILL VOID THE SUBJECT WARRANTY:

- Damage to the product caused by the property owner by use of landscape, gardening equipment, chemicals that may cause damage, and/or water sprinklers with high mineral content;
- Damage caused by adhesion of chicken wire, chain link mesh, welded wire, or other similar substance to the product;
- Damage caused by allowing plant life of any sort to grow directly upon or in contact with any portion of the product or sap from trees;
- Any alteration to the product itself by the property owner including any on-site cutting or welding; and/or, failure to follow any and all maintenance instructions provided by Ameristar at the time of sale to the original purchaser even if these instructions are not forwarded to the ultimate claimant under this warranty.
- When cutting Montage immediately seal the exposed surfaces by 1) Removing all metal shavings from the cut area 2) Applying zinc-rich primer to thoroughly cover cut edge and drilled hole and, after letting dry, 3) Applying two (2) coats of custom finish spray paint matching fence color. Failure to seal exposed surfaces per steps 1-3 above will negate warranty.
- If contractor uses non-Ameristar parts/components, this will negate the warranty.

Ameristar Montage welded ornamental fences are also guaranteed for the same period of time against defects in workmanship or materials. Should any Montage welded ornamental panel or post manufactured by Ameristar fail in accordance with any of the above conditions, Ameristar warrants to the original purchaser their redemption through replacement, renewal or issuance of a pro-rated credit. The choice of redemption method is solely at the discretion of Ameristar. If the pro-rated alternative is chosen, the amount will be based on the original cost of materials at the date of purchase multiplied by the appropriate time and exposure factor from the table below:

APPLICATION	LENGTH OF WARRANTY
Fence Installations 0 to 1 Mile from Salt Water Coast Line	5 YEARS
Fence Installations 1 Mile to 10 Miles from Salt Water Coast Line	10 YEARS
Fence Installations Over 10 Miles from Salt Water Coast Line	20 YEARS

Regardless of location and years in service, evidence of historical salt spray exposure shall be considered as grounds to void any warranty obligations.

Notice of failure under the conditions of this warranty shall be sent to Ameristar or its authorized representative, in writing, together with proof of purchase and shall specify the nature of the defect and when it was first observed as well as photographs of current site conditions. Should the fence be improperly installed, Ameristar shall not be responsible for guaranteed performance or appearance of the material. Neither does this guarantee apply when failure or damage is due to improper use or application, abuse or misuse, salt spray exposure (see Table and Note above), vandalism, or acts of God. Ameristar reserves the right to inspect the material to determine validity of the claim.

Upon acceptance of the claim by Ameristar or its authorized representative, redemption by replacement, renewal or issuance of a pro-rated credit shall be made by Ameristar. Reimbursement for labor necessary to restore and/or replace components that have been found defective under the terms of this warranty is guaranteed to the original purchaser for a period of five (5) years from the original purchase date. Ameristar reserves the right to select the qualified company or individual to perform the labor to repair or replace the components that are deemed to be defective under the terms of this warranty.

The above constitutes the complete warranty by the manufacturer. No other agreement, written or implied, is valid. Ameristar Fence Products does not authorize any other person or agent to make any other express warranties. Ameristar neither assumes nor authorizes any other person or agent to assume any other liability in connection with the Montage welded ornamental fence system.

Effective: 01/01/14

MONTAGE® | CONSTRUCTION SPECIFICATION 32 31 19

STEEL ORNAMENTAL FENCE SYSTEM – FUSION WELDED

PART 1 - GENERAL

1.01 WORK INCLUDED

The contractor shall provide all labor, materials and appurtenances necessary for installation of the welded ornamental steel fence system defined herein at (specify project site).

1.02 RELATED WORK

Section _____ - Earthwork

Section _____ - Concrete

1.03 SYSTEM DESCRIPTION

The manufacturer shall supply a total fence system of (specify Montage® standard picket space or Montage Pool, Pet & Play® 3" air space) Welded and Rackable (ATF – All Terrain Flexibility) Ornamental Steel, (for standard picket space, specify Classic™, Majestic™, Genesis™, Warrior™, Crescent™; for 3" air-space specify Classic, Majestic, Genesis, or Gemini™) design. The system shall include all components (i.e., panels, posts, gates and hardware) required.

1.04 QUALITY ASSURANCE

The contractor shall provide laborers and supervisors who are thoroughly familiar with the type of construction involved and materials and techniques specified.

1.05 REFERENCES

- **ASTM A653/A653M** – Standard Specification for Steel Sheet, Zinc-Coated (Galvanized) or Zinc-Iron Alloy Coated (Galvannealed) by the Hot-Dip Process
- **ASTM B117** – Practice for Operating Salt-Spray (Fog) Apparatus
- **ASTM D523** – Test Method for Specular Gloss
- **ASTM D714** – Test Method for Evaluating Degree of Blistering in Paint
- **ASTM D822** – Practice for Conducting Tests on Paint and Related Coatings and Materials using Filtered Open-Flame Carbon-Arc Light and Water Exposure Apparatus
- **ASTM D1654** – Test Method for Evaluation of Painted or Coated Specimens Subjected to Corrosive Environments
- **ASTM D2244** – Test Method for Calculation of Color Differences from Instrumentally Measured Color Coordinates
- **ASTM D2794** – Test Method for Resistance of Organic Coatings to the Effects of Rapid Deformation (Impact)
- **ASTM D3359** – Test Method for Measuring Adhesion by Tape Test
- **ASTM F2408** – Ornamental Fences Employing Galvanized Steel Tubular Pickets

1.06 SUBMITTAL

The manufacturer's literature shall be submitted prior to installation.

1.07 PRODUCT HANDLING AND STORAGE

Upon receipt at the job site, all materials shall be checked to ensure that no damage occurred during shipping or handling. Materials shall be stored in such a manner to ensure proper ventilation and drainage, and to protect against damage, weather, vandalism and theft.

1.08 PRODUCT WARRANTY

- All structural fence components (i.e. rails, pickets, and posts) shall be warranted within specified limitations, by the manufacturer for a period of 20 years from date of original purchase. Warranty shall cover any defects in material finish, including cracking, peeling, chipping, blistering or corroding.
- Reimbursement for labor necessary to restore or replace components that have been found to be defective under the terms of manufacturer's warranty shall be guaranteed for five (5) years from date of original purchase.

PART 2 - MATERIALS

2.01 MANUFACTURER

The fence system shall conform to (specify Montage standard picket space or Montage Pool, Pet & Play 3" air space) Welded and Rackable (ATF – All Terrain Flexibility) Ornamental Steel, (for standard picket space, specify Classic, Majestic, Genesis, Warrior, Crescent; for 3" air-space specify Classic, Majestic, Genesis, or Gemini) design, (specify extended picket or flush) bottom rail treatment, (specify 2-Rail or 3-Rail) style manufactured by Ameristar Fence Products, Inc., in Tulsa, Oklahoma.

2.02 MATERIAL

- Steel material for fence panels and posts shall conform to the requirements of **ASTM A653/A653M**, with a minimum yield strength of 45,000 psi (310 MPa) and a minimum zinc (hot-dip galvanized) coating weight of 0.60 oz/ft² (184 g/m²), Coating Designation G-60.
- Material for pickets shall be 5/8" square x 18 Ga. tubing. The rails shall be steel channel, 1.25" x 0.92" x 14 Ga. Picket holes in the rail shall be spaced (specify 4.334" o.c. for standard picket space or 3.500" o.c. for 3" air space). Fence posts shall be a minimum of 2" square x 16 Ga. Gate posts shall meet the minimum requirements of **Table 1**.

2.03 FABRICATION

- Pickets, rails and posts shall be pre-cut to specified lengths. Rails shall be pre-punched to accept pickets.
- Pickets shall be inserted into the pre-punched holes in the rails and shall be aligned to standard spacing using a specially calibrated alignment fixture. The aligned pickets and rails shall be joined at each picket-to-rail intersection by Ameristar's proprietary fusion welding process, thus completing the rigid panel assembly (Note: The process produces a virtually seamless, spatter-free good-neighbor appearance, equally attractive from either side of the panel).
- The manufactured panels and posts shall be subjected to an inline electrode position coating (E-Coat) process consisting of a multi-stage pretreatment/wash (with zinc phosphate), followed by a duplex application of an epoxy primer and an acrylic topcoat. The minimum cumulative coating thickness of epoxy and acrylic shall be 2 mils (0.050 mm). The color shall be (specify Black or Bronze). The coated panels and posts shall be capable of meeting the performance requirements for each quality characteristic shown in **Table 2** (Note: The requirements in Table 2 meet or exceed the coating performance criteria of **ASTM F2408**).
- The manufactured fence system shall be capable of meeting the vertical load, horizontal load, and infill performance requirements for Industrial weight fences under **ASTM F2408**.
- Gates shall be fabricated using welded ornamental panel material and gate ends having a 1.25" square cross-sectional size. All rail and upright intersections shall be joined by welding. All picket and rail intersections shall also be joined by welding.

PART 3 - EXECUTION

3.01 PREPARATION

All new installation shall be laid out by the contractor in accordance with the construction plans.

3.02 FENCE INSTALLATION

Fence post shall be spaced according to **Table 3**, plus or minus .5". For installations that must be raked to follow sloping grades, the post spacing dimension must be measured along the grade. Fence panels shall be attached to posts with brackets supplied by the manufacturer. The "Earthwork" and "Concrete" sections of this specification shall govern material requirements for the concrete footer.

Effective: 01/01/14

MONTAGE® | CONSTRUCTION SPECIFICATION 32 31 19

STEEL ORNAMENTAL FENCE SYSTEM – FUSION WELDED

3.03 FENCE INSTALLATION MAINTENANCE

When cutting/drilling rails or posts adhere to the following steps to seal the exposed steel surfaces; 1) Remove all metal shavings from cut area. 2) Apply zinc-rich primer to thoroughly cover cut edge and/or drilled hole; let dry. 3) Apply 2 coats of custom finish paint matching fence color. Failure to seal exposed surfaces per steps 1-3 above will negate warranty. Ameristar spray cans or paint pens shall be used to prime and finish exposed surfaces; it is recommended that paint pens be used to prevent overspray. Use of non-Ameristar parts or components will negate the manufacturers' warranty.

3.04 GATE INSTALLATION

Gate posts shall be spaced according to the manufacturers' gate drawings, dependent on standard out-to-out gate leaf dimensions and gate hardware selected. Type and quantity of gate hinges shall be based on the application; weight, height, and number of gate cycles. The manufacturers' gate drawings shall identify the necessary gate hardware required for the application. Gate hardware shall be provided by the manufacturer of the gate and shall be installed per manufacturer's recommendations.

3.05 CLEANING

The contractor shall clean the jobsite of excess materials; post-hole excavations shall be scattered uniformly away from posts.

TABLE 1

MINIMUM SIZES FOR MONTAGE POSTS		
GATE LEAF	GATE HEIGHT	
	up to & including 4' height	over 4'; up to & including 6' height
up to 4'	2" x 16 gauge	2" x 16 gauge
4'1" to 6'	2" x 16 gauge	2.5" x 16 gauge
6'1" to 8'	2.5" x 16 gauge	2.5" x 16 gauge

TABLE 2

COATING PERFORMANCE REQUIREMENTS		
QUALITY CHARACTERISTICS	ASTM TEST METHOD	PERFORMANCE REQUIREMENTS
ADHESION	D3359 – METHOD B	Adhesion (retention of coating) over 90% of test area (tape and knife kit test).
CORROSION RESISTANCE	B117, D714, D1654	Corrosion resistance over 1,000 hours (scribed per D1654; failure mode is accumulation of 1/8" coating loss from scribe or medium #8 blisters)
IMPACT RESISTANCE	D2794	Impact resistance over 60" lb. (forward impact using 0.625" ball).
WEATHERING RESISTANCE	D822 D2244, D523 (60° method)	Weathering resistance over 1,000 hours (failure mode is 60% loss of gloss or color variance of more than 3 delta-E color units).

TABLE 3

MONTAGE POST SPACING BY BRACKET TYPE				
SPAN	Classic, Genesis, Majestic, Warrior, Crescent & Gemini / 8' nominal (94" rail)			
POST SIZE	2"	2"	2"	2.5"
BRACKET TYPE	Montage Universal (BB102)	Montage Line Blvd. (BB104)	Montage Flat Mount (BB105)	Montage Swivel (BB106)*
POST SETTINGS + .5" O.C.	96.75"	96.75"	96.75"	*96.75"

* When using BB106 swivel brackets on either or both ends of a panel installation, care must be taken to ensure the spacing between post and adjoining pickets meets applicable codes. This will require trimming one or both ends of the panel.

Effective: 01/01/14

MONTAGE® | SINGLE SWING GATE SPECIFICATIONS

1.25"sq x 16ga GATE ENDS | .9375"w x 1.25"h x 14ga RAILS | .590"sq x 18ga PICKETS

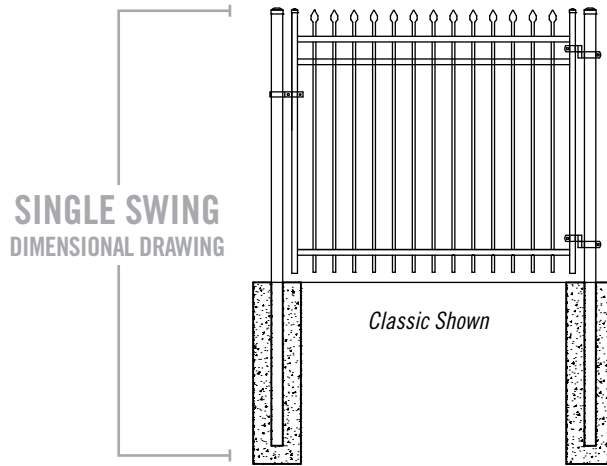

OPENING	LEAF WIDTH*	D&D GATE HARDWARE KIT			D&D POOL GATE HARDWARE KIT		
		HC	LC	P _S	HC	LC	P _S
3.5'	36.5"	1.125"	.75"	38.375"	1.125"	.75"	38.375"
4'	45"	1.125"	.75"	46.875"	1.125"	.75"	46.875"
5'	62.5"	1.125"	.75"	64.375"	1.125"	.75"	64.375"
6'	71"	1.125"	.75"	72.875"	1.125"	.75"	72.875"
7'	79.75"	1.125"	.75"	81.625"	1.125"	.75"	81.625"
8'	96.5"	1.125"	.75"	98.375"	1.125"	.75"	98.375"

SINGLE SWING HARDWARE KITS & POST INTERSPACES

W = width* | HC = hinge clearance | LC = latch clearance | P_S = gate post spacing**
 * From outside to outside | ** From inside to inside

DSKM gate hardware included / see section for specific details
 DSKP gate hardware (pool gates) included / see section for specific details
Note: 7' & 8' OPENINGS DO NOT INCLUDE GATE HARDWARE

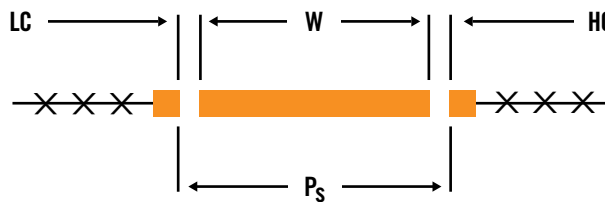

Effective: 01/01/14

MONTAGE® | DOUBLE SWING GATE SPECIFICATIONS

1.25"sq x 16ga GATE ENDS | .9375"w x 1.25"h x 14ga RAILS | .590"sq x 18ga PICKETS

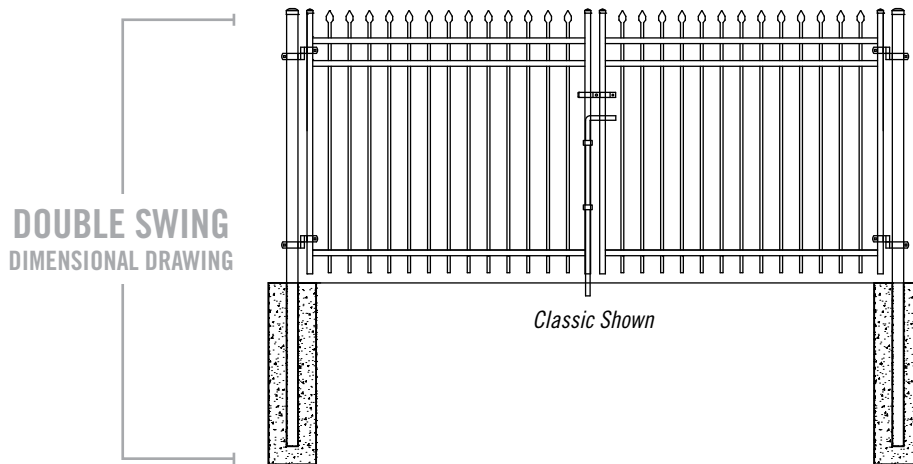

D&D GATE HARDWARE KIT

OPENING	LEAF WIDTH*	HC	LC	P _d
7'	36.5"	.75"	.75"	75.25"
8'	45"	.75"	.75"	92.25"
10'	62.5"	.75"	.75"	127.25"
12'	71"	.75"	.75"	144.25"
14'	79.75"	.75"	.75"	161.75"
16'	96.5"	.75"	.75"	195.25"

DOUBLE SWING HARDWARE KITS & POST INTERSPACES

W = width (x2)* | HC = hinge clearance (x2) | LC = latch clearance
 P_d = gate post spacing**
 * From outside to outside | ** From inside to inside

DDKM gate hardware included / see section for specific details

Note: 7' & 8' OPENINGS DO NOT INCLUDE GATE HARDWARE

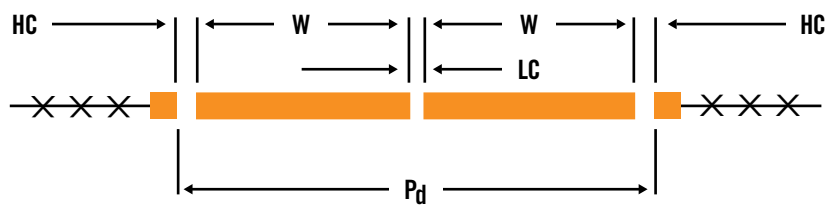

Effective: 01/01/14

MONTAGE® | 2-RAIL SINGLE SWING GATES

4" AIR GAP | STANDARD BOTTOM | GATE HARDWARE INCLUDED (excluding 7' & 8' openings)

	OPENING	LEAF WIDTH	ITEM NUMBER	PICKET QTY	WEIGHT	STOCKING
3' HEIGHT	3.5'	36.5"	W☒⊗234-42M*	7	19 lbs	☉
	4'	45"	W☒⊗234-48M	9	22 lbs	☉
	5'	62.5"	W☒⊗234-60M*	13	27 lbs	☉
	6'	71"	W☒⊗234-72M	15	30 lbs	☉
	7'	79.75"	W☒⊗234-84	17†	31 lbs	☉
3.5' HEIGHT	3.5'	36.5"	W☒⊗240-42M*	7	21 lbs	☉
	4'	45"	W☒⊗240-48M	9	24 lbs	☉
	5'	62.5"	W☒⊗240-60M*	13	31 lbs	☉
	6'	71"	W☒⊗240-72M	15	34 lbs	☉
	7'	79.75"	W☒⊗240-84	17†	35 lbs	☉
4' HEIGHT	3.5'	36.5"	W☒⊗246-42M*	7	26 lbs	☉
	4'	45"	W☒⊗246-48M	9	27 lbs	CB MB GB
	5'	62.5"	W☒⊗246-60M*	13	34 lbs	CB MB GB
	6'	71"	W☒⊗246-72M	15	37 lbs	CB MB
	7'	79.75"	W☒⊗246-84	17†	39 lbs	☉
5' HEIGHT	3.5'	36.5"	W☒⊗258-42M*	7	31 lbs	☉
	4'	45"	W☒⊗258-48M	9	32 lbs	CB MB GB
	5'	62.5"	W☒⊗258-60M*	13	38 lbs	CB MB
	6'	71"	W☒⊗258-72M	15	44 lbs	☉
	7'	79.75"	W☒⊗258-84	17†	46 lbs	☉
	8'	96.5"	W☒⊗258-96	21	55 lbs	☉

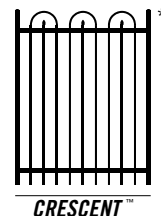
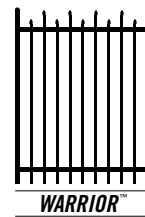
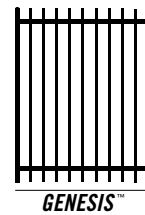
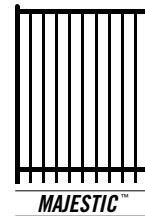
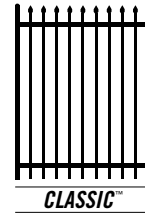

☒ = FENCE STYLES AVAILABLE | **C** = Classic | **M** = Majestic | **G** = Genesis | **W** = Warrior | **L** = Crescent*

⊗ = COLOR OPTIONS AVAILABLE | **B** = Black | **N** = Bronze

☉ = NON-STOCKED PRODUCT | For details, see Ameristar's Sales Policy in the catalog guide.

*Not available in Crescent for 3.5' or 5' gate openings | †18 pickets per gate leaf in Crescent

Notes: Gate heights are nominal & gate widths are actual. For details about gate hardware included with these gates, see the Montage Gate introduction at the beginning of this section. (Hardware not included for 7' & 8' openings).

Effective: 01/01/14

MONTAGE® | 2-RAIL DOUBLE SWING GATES

4" AIR GAP | STANDARD BOTTOM | GATE HARDWARE INCLUDED (excluding 14' & 16' openings)

	OPENING	LEAF WIDTH	ITEM NUMBER	PICKET QTY	WEIGHT	STOCKING
3' HEIGHT	7'	36.5"	W☒Ⓞ234-84MD*	7	40 lbs	☉
	8'	45"	W☒Ⓞ234-96MD	9	46 lbs	☉
	10'	62.5"	W☒Ⓞ234-120MD*	13	56 lbs	☉
	12'	71"	W☒Ⓞ234-144MD	15	62 lbs	☉
	14'	79.75"	W☒Ⓞ234-168D	17†	68 lbs	☉
	16'	96.5"	W☒Ⓞ234-192D	21	72 lbs	☉
3.5' HEIGHT	7'	36.5"	W☒Ⓞ240-84MD*	7	44 lbs	☉
	8'	45"	W☒Ⓞ240-96MD	9	50 lbs	☉
	10'	62.5"	W☒Ⓞ240-120MD*	13	64 lbs	☉
	12'	71"	W☒Ⓞ240-144MD	15	70 lbs	☉
	14'	79.75"	W☒Ⓞ240-168D	17†	76 lbs	☉
	16'	96.5"	W☒Ⓞ240-192D	21	82 lbs	☉
4' HEIGHT	7'	36.5"	W☒Ⓞ246-84MD*	7	52 lbs	☉
	8'	45"	W☒Ⓞ246-96MD	9	56 lbs	CB MB GB
	10'	62.5"	W☒Ⓞ246-120MD*	13	66 lbs	CB MB GB
	12'	71"	W☒Ⓞ246-144MD	15	76 lbs	CB MB
	14'	79.75"	W☒Ⓞ246-168D	17†	84 lbs	☉
	16'	96.5"	W☒Ⓞ246-192D	21	92 lbs	☉
5' HEIGHT	7'	36.5"	W☒Ⓞ258-84MD*	7	62 lbs	☉
	8'	45"	W☒Ⓞ258-96MD	9	66 lbs	CB MB GB
	10'	62.5"	W☒Ⓞ258-120MD*	13	78 lbs	CB MB
	12'	71"	W☒Ⓞ258-144MD	15	90 lbs	☉
	14'	79.75"	W☒Ⓞ258-168D	17†	98 lbs	☉
	16'	96.5"	W☒Ⓞ258-192D	21	110 lbs	☉

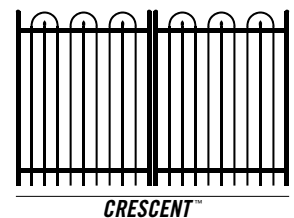
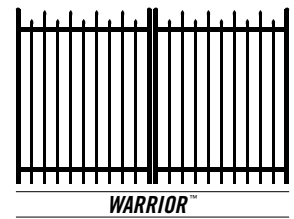
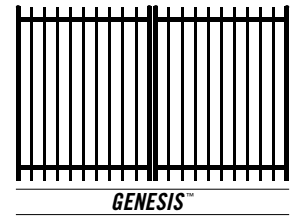
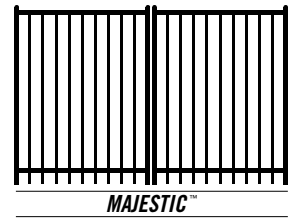
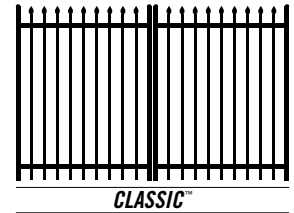

☒ = FENCE STYLES AVAILABLE | **C** = Classic **M** = Majestic **G** = Genesis **W** = Warrior **L** = Crescent*

Ⓞ = COLOR OPTIONS AVAILABLE | **B** = Black **N** = Bronze

☉ = NON-STOCKED PRODUCT | For details, see Ameristar's Sales Policy in the catalog guide.

*Not available in Crescent for 7' or 10' gate openings | †18 pickets per gate leaf in Crescent

Notes: Two gate leaves included for double all gates. Gate heights are nominal & gate widths are actual. For details about gate hardware included with these gates, see the Montage Gate introduction at the beginning of this section. (Hardware not included for 14' & 16' openings).

Effective: 01/01/14

MONTAGE® | 2-RAIL SINGLE SWING GATES

3" AIR GAP | STANDARD BOTTOM | GATE HARDWARE INCLUDED (excluding 7' & 8' openings)

	OPENING	LEAF WIDTH	ITEM NUMBER	PICKET QTY	WEIGHT	STOCKING
3' HEIGHT	3.5'	36.5"	R☒Ⓞ234-42M	9 / 10†	19 lbs	☉
	4'	45"	R☒Ⓞ234-48M	11 / 12†	23 lbs	☉
	5'	62.5"	R☒Ⓞ234-60M	16	29 lbs	☉
	6'	71"	R☒Ⓞ234-72M	19 / 18†	34 lbs	☉
	7'	79.75"	R☒Ⓞ234-84	21 / 22†	39 lbs	☉
	8'	96.5"	R☒Ⓞ234-96	26	42 lbs	☉
3.5' HEIGHT	3.5'	36.5"	R☒Ⓞ240-42M	9 / 10†	23 lbs	☉
	4'	45"	R☒Ⓞ240-48M	11 / 12†	26 lbs	☉
	5'	62.5"	R☒Ⓞ240-60M	16	33 lbs	☉
	6'	71"	R☒Ⓞ240-72M	19 / 18†	38 lbs	☉
	7'	79.75"	R☒Ⓞ240-84	21 / 22†	41 lbs	☉
	8'	96.5"	R☒Ⓞ240-96	26	45 lbs	☉
4' HEIGHT	3.5'	36.5"	R☒Ⓞ246-42M	9 / 10†	27 lbs	☉
	4'	45"	R☒Ⓞ246-48M	11 / 12†	30 lbs	☉
	5'	62.5"	R☒Ⓞ246-60M	16	36 lbs	☉
	6'	71"	R☒Ⓞ246-72M	19 / 18†	42 lbs	☉
	7'	79.75"	R☒Ⓞ246-84	21 / 22†	44 lbs	☉
	8'	96.5"	R☒Ⓞ246-96	26	52 lbs	☉

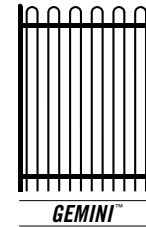
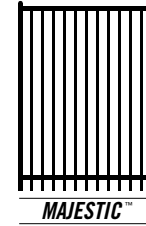

☒ = GATE STYLES AVAILABLE | M = Majestic H = Gemini

Ⓞ = COLOR OPTIONS AVAILABLE | B = Black N = Bronze

☉ = NON-STOCKED PRODUCT | For details, see Ameristar's Sales Policy in the catalog guide.

† Number of pickets per gate leaf in Gemini

Notes: Gate heights are nominal & gate widths are actual. For details about gate hardware included with these gates, see the Montage Gate introduction at the beginning of this section. (Hardware not included for 7' & 8' openings).

Effective: 01/01/14

MONTAGE® | 2-RAIL DOUBLE SWING GATES

3" AIR GAP | STANDARD BOTTOM | GATE HARDWARE INCLUDED (excluding 14' & 16' openings)

	OPENING	LEAF WIDTH	ITEM NUMBER	PICKET QTY	WEIGHT	STOCKING
3' HEIGHT	7'	36.5"	R☒Ⓞ234-84MD	9 / 10†	44 lbs	⊖
	8'	45"	R☒Ⓞ234-96MD	11 / 12†	48 lbs	⊖
	10'	62.5"	R☒Ⓞ234-120MD	16	60 lbs	⊖
	12'	71"	R☒Ⓞ234-144MD	19 / 18†	70 lbs	⊖
	14'	79.75"	R☒Ⓞ234-168D	21 / 22†	68 lbs	⊖
	16'	96.5"	R☒Ⓞ234-192D	26	80 lbs	⊖
3.5' HEIGHT	7'	36.5"	R☒Ⓞ240-84MD	9 / 10†	48 lbs	⊖
	8'	45"	R☒Ⓞ240-96MD	11 / 12†	54 lbs	⊖
	10'	62.5"	R☒Ⓞ240-120MD	16	68 lbs	⊖
	12'	71"	R☒Ⓞ240-144MD	19 / 18†	78 lbs	⊖
	14'	79.75"	R☒Ⓞ240-168D	21 / 22†	78 lbs	⊖
	16'	96.5"	R☒Ⓞ240-192D	26	90 lbs	⊖
4' HEIGHT	7'	36.5"	R☒Ⓞ246-84MD	9 / 10†	56 lbs	⊖
	8'	45"	R☒Ⓞ246-96MD	11 / 12†	62 lbs	⊖
	10'	62.5"	R☒Ⓞ246-120MD	16	74 lbs	⊖
	12'	71"	R☒Ⓞ246-144MD	19 / 18†	86 lbs	⊖
	14'	79.75"	R☒Ⓞ246-168D	21 / 22†	88 lbs	⊖
	16'	96.5"	R☒Ⓞ246-192D	26	104 lbs	⊖

☒ = GATE STYLES AVAILABLE | **M** = Majestic **H** = Gemini

Ⓞ = COLOR OPTIONS AVAILABLE | **B** = Black **N** = Bronze

⊖ = NON-STOCKED PRODUCT | For details, see Ameristar's Sales Policy in the catalog guide.

† Number of pickets per gate leaf in Gemini

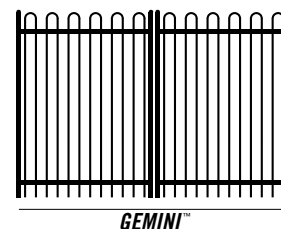
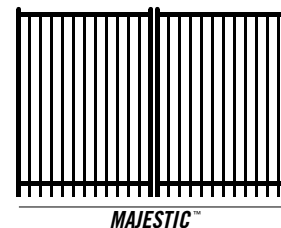

Notes: Two gate leaves included for double all gates. Gate heights are nominal & gate widths are actual. For details about gate hardware included with these gates, see the Montage Gate introduction at the beginning of this section. (Hardware not included for 14' & 16' openings).

Effective: 01/01/14

MONTAGE® | 2-RAIL SINGLE SWING GATES

4" AIR GAP | FLUSH BOTTOM | GATE HARDWARE INCLUDED (excluding 7' & 8' openings)

	OPENING	LEAF WIDTH	ITEM NUMBER	PICKET QTY	WEIGHT	STOCKING
3' HEIGHT	3.5'	36.5"	W☒ⓧ234F-42M*	7	19 lbs	☉
	4'	45"	W☒ⓧ234F-48M	9	22 lbs	☉
	5'	62.5"	W☒ⓧ234F-60M*	13	27 lbs	☉
	6'	71"	W☒ⓧ234F-72M	15	30 lbs	☉
	7'	79.75"	W☒ⓧ234F-84	17†	31 lbs	☉
	8'	96.5"	W☒ⓧ234F-96	21	36 lbs	☉
3.5' HEIGHT	3.5'	36.5"	W☒ⓧ240F-42M*	7	22 lbs	☉
	4'	45"	W☒ⓧ240F-48M	9	24 lbs	☉
	5'	62.5"	W☒ⓧ240F-60M*	13	31 lbs	☉
	6'	71"	W☒ⓧ240F-72M	15	34 lbs	☉
	7'	79.75"	W☒ⓧ240F-84	17†	35 lbs	☉
	8'	96.5"	W☒ⓧ240F-96	21	41 lbs	☉
4' HEIGHT	3.5'	36.5"	W☒ⓧ246F-42M*	7	25 lbs	☉
	4'	45"	W☒ⓧ246F-48M	9	27 lbs	MB
	5'	62.5"	W☒ⓧ246F-60M*	13	34 lbs	MB
	6'	71"	W☒ⓧ246F-72M	15	37 lbs	☉
	7'	79.75"	W☒ⓧ246F-84	17†	39 lbs	☉
	8'	96.5"	W☒ⓧ246F-96	21	46 lbs	☉
4' HEIGHT	3.5' POOL	36.5"	WM☒ⓧ246F-42P*	7	25 lbs	☉
	4' POOL	45"	WM☒ⓧ246F-48P	9	27 lbs	MB
	5' POOL	62.5"	WM☒ⓧ246F-60P*	13	34 lbs	MB
	6' POOL	71"	WM☒ⓧ246F-72P	9	37 lbs	☉
5' HEIGHT	3.5'	36.5"	W☒ⓧ258F-42M*	7	31 lbs	☉
	4'	45"	W☒ⓧ258F-48M	9	32 lbs	MB
	5'	62.5"	W☒ⓧ258F-60M*	13	38 lbs	☉
	6'	71"	W☒ⓧ258F-72M	15	44 lbs	☉
	7'	79.75"	W☒ⓧ258F-84	17	46 lbs	☉
	8'	96.5"	W☒ⓧ258F-96	21	55 lbs	☉

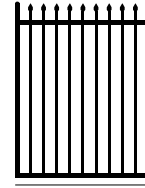

CLASSIC™

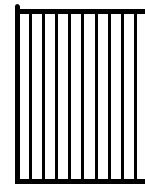

MAJESTIC™

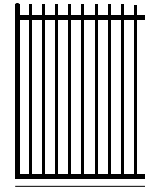

GENESIS™

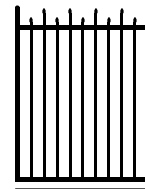

WARRIOR™

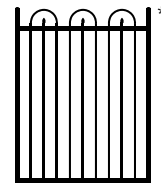

CRESCENT™

☒ = FENCE STYLES AVAILABLE | C = Classic M = Majestic G = Genesis W = Warrior L = Crescent*

ⓧ = COLOR OPTIONS AVAILABLE | B = Black N = Bronze

☉ = NON-STOCKED PRODUCT | For details, see Ameristar's Sales Policy in the catalog guide.

*Not available in Crescent for 3.5' or 5' gate openings | † 18 pickets per gate leaf in Crescent
 Pool gates only available in Majestic

Notes: Gate heights are nominal & gate widths are actual. For details about gate hardware included with these gates, see the Montage Gate introduction at the beginning of this section. (Hardware not included for 7' & 8' openings).

Effective: 01/01/14

MONTAGE® | 2-RAIL DOUBLE SWING GATES

4" AIR GAP | FLUSH BOTTOM | GATE HARDWARE INCLUDED (excluding 14' & 16' openings)

	OPENING	LEAF WIDTH	ITEM NUMBER	PICKET QTY	WEIGHT	STOCKING
3' HEIGHT	7'	36.5"	W☒Ⓞ234F-84MD*	7	40 lbs	☉
	8'	45"	W☒Ⓞ234F-96MD	9	46 lbs	☉
	10'	62.5"	W☒Ⓞ234F-120MD*	13	56 lbs	☉
	12'	71"	W☒Ⓞ234F-144MD	15	62 lbs	☉
	14'	79.75"	W☒Ⓞ234F-168D	17†	68 lbs	☉
	16'	96.5"	W☒Ⓞ234F-192D	21	72 lbs	☉
3.5' HEIGHT	7'	36.5"	W☒Ⓞ240F-84MD*	7	44 lbs	☉
	8'	45"	W☒Ⓞ240F-96MD	9	50 lbs	☉
	10'	62.5"	W☒Ⓞ240F-120MD*	13	64 lbs	☉
	12'	71"	W☒Ⓞ240F-144MD	15	70 lbs	☉
	14'	79.75"	W☒Ⓞ240F-168D	17†	76 lbs	☉
	16'	96.5"	W☒Ⓞ240F-192D	21	82 lbs	☉
4' HEIGHT	7'	36.5"	W☒Ⓞ246F-84MD*	7	52 lbs	☉
	8'	45"	W☒Ⓞ246F-96MD	9	56 lbs	MB
	10'	62.5"	W☒Ⓞ246F-120MD*	13	66 lbs	MB
	12'	71"	W☒Ⓞ246F-144MD	15	76 lbs	☉
	14'	79.75"	W☒Ⓞ246F-168D	17†	84 lbs	☉
	16'	96.5"	W☒Ⓞ246F-192D	21	92 lbs	☉
5' HEIGHT	7'	36.5"	W☒Ⓞ258F-84MD*	7	62 lbs	☉
	8'	45"	W☒Ⓞ258F-96MD	9	66 lbs	MB
	10'	62.5"	W☒Ⓞ258F-120MD*	13	78 lbs	☉
	12'	71"	W☒Ⓞ258F-144MD	15	90 lbs	☉
	14'	79.75"	W☒Ⓞ258F-168D	17†	98 lbs	☉
	16'	96.5"	W☒Ⓞ258F-192D	21	110 lbs	☉

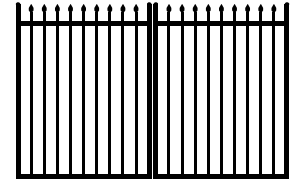

CLASSIC™

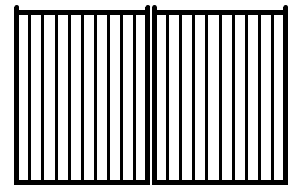

MAJESTIC™

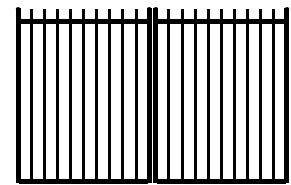

GENESIS™

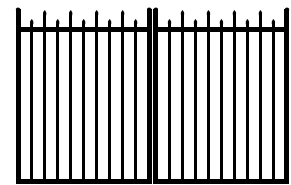

WARRIOR™

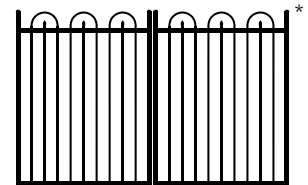

CRESCENT™

☒ = FENCE STYLES AVAILABLE | C = Classic M = Majestic G = Genesis W = Warrior L = Crescent*

Ⓞ = COLOR OPTIONS AVAILABLE | B = Black N = Bronze

☉ = NON-STOCKED PRODUCT | For details, see Ameristar's Sales Policy in the catalog guide.

*Not available in Crescent for 7' or 10' gate openings | †18 pickets per gate leaf in Crescent

Notes: Two gate leaves included for double all gates. Gate heights are nominal & gate widths are actual. For details about gate hardware included with these gates, see the Montage Gate introduction at the beginning of this section. (Hardware not included for 14' & 16' openings).

Effective: 01/01/14

MONTAGE® | 2-RAIL SINGLE SWING GATES

3" AIR GAP | FLUSH BOTTOM | GATE HARDWARE INCLUDED (excluding 7' & 8' openings)

	OPENING	LEAF WIDTH	ITEM NUMBER	PICKET QTY	WEIGHT	STOCKING
3' HEIGHT	3.5'	36.5"	R☒⊗234F-42M	9 / 10†	19 lbs	⊙
	4'	45"	R☒⊗234F-48M	11 / 12†	23 lbs	⊙
	5'	62.5"	R☒⊗234F-60M	16	29 lbs	⊙
	6'	71"	R☒⊗234F-72M	19 / 18†	34 lbs	⊙
	7'	79.75"	R☒⊗234F-84	21 / 22†	39 lbs	⊙
3.5' HEIGHT	3.5'	36.5"	R☒⊗240F-42M	9 / 10†	23 lbs	⊙
	4'	45"	R☒⊗240F-48M	11 / 12†	26 lbs	⊙
	5'	62.5"	R☒⊗240F-60M	16	33 lbs	⊙
	6'	71"	R☒⊗240F-72M	19 / 18†	38 lbs	⊙
	7'	79.75"	R☒⊗240F-84	21 / 22†	41 lbs	⊙
4' HEIGHT	3.5'	36.5"	R☒⊗246F-42M	9 / 10†	28 lbs	⊙
	4'	45"	R☒⊗246F-48M	11 / 12†	31 lbs	⊙
	5'	62.5"	R☒⊗246F-60M	16	37 lbs	⊙
	6'	71"	R☒⊗246F-72M	19 / 18†	43 lbs	⊙
	7'	79.75"	R☒⊗246F-84	21 / 22†	44 lbs	⊙
4' HEIGHT	3.5' POOL	36.5"	RM☒⊗246F-42P	9 / 10†	28 lbs	⊙
	4' POOL	45"	RM☒⊗246F-48P	11 / 12†	31 lbs	⊙
	5' POOL	62.5"	RM☒⊗246F-60P	16	37 lbs	⊙
	6' POOL	71"	RM☒⊗246F-72P	19 / 18†	43 lbs	⊙
5' HEIGHT	3.5'	36.5"	R☒⊗258F-42M	9 / 10†	33 lbs	⊙
	4'	45"	R☒⊗258F-48M	11 / 12†	36 lbs	⊙
	5'	62.5"	R☒⊗258F-60M	16	43 lbs	⊙
	6'	71"	R☒⊗258F-72M	19 / 18†	51 lbs	⊙
	7'	79.75"	R☒⊗258F-84	21 / 22†	55 lbs	⊙
	8'	96.5"	R☒⊗258F-96	26	65 lbs	⊙

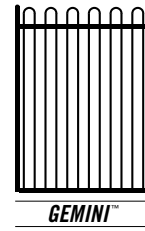
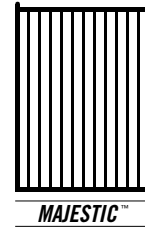

☒ = GATE STYLES AVAILABLE | M = Majestic | H = Gemini

⊗ = COLOR OPTIONS AVAILABLE | B = Black | N = Bronze

⊙ = NON-STOCKED PRODUCT | For details, see Ameristar's Sales Policy in the catalog guide.

Pool gates only available in Majestic | † Number of pickets per gate leaf in Gemini

Notes: Gate heights are nominal & gate widths are actual. For details about gate hardware included with these gates, see the Montage Gate introduction at the beginning of this section. (Hardware not included for 7' & 8' openings).

Effective: 01/01/14

MONTAGE® | 2-RAIL DOUBLE SWING GATES

3" AIR GAP | FLUSH BOTTOM | GATE HARDWARE INCLUDED (excluding 14' & 16' openings)

	OPENING	LEAF WIDTH	ITEM NUMBER	PICKET QTY	WEIGHT	STOCKING
3' HEIGHT	7'	36.5"	R☒☒234F-84MD	9 / 10†	44 lbs	☉
	8'	45"	R☒☒234F-96MD	11 / 12†	48 lbs	☉
	10'	62.5"	R☒☒234F-120MD	16	60 lbs	☉
	12'	71"	R☒☒234F-144MD	19 / 18†	70 lbs	☉
	14'	79.75"	R☒☒234F-168D	21 / 22†	68 lbs	☉
	16'	96.5"	R☒☒234F-192D	26	80 lbs	☉
3.5' HEIGHT	7'	36.5"	R☒☒240F-84MD	9 / 10†	48 lbs	☉
	8'	45"	R☒☒240F-96MD	11 / 12†	54 lbs	☉
	10'	62.5"	R☒☒240F-120MD	16	68 lbs	☉
	12'	71"	R☒☒240F-144MD	19 / 18†	78 lbs	☉
	14'	79.75"	R☒☒240F-168D	21 / 22†	78 lbs	☉
	16'	96.5"	R☒☒240F-192D	26	90 lbs	☉
4' HEIGHT	7'	36.5"	R☒☒246F-84MD	9 / 10†	56 lbs	☉
	8'	45"	R☒☒246F-96MD	11 / 12†	62 lbs	☉
	10'	62.5"	R☒☒246F-120MD	16	74 lbs	☉
	12'	71"	R☒☒246F-144MD	19 / 18†	86 lbs	☉
	14'	79.75"	R☒☒246F-168D	21 / 22†	88 lbs	☉
	16'	96.5"	R☒☒246F-192D	26	104 lbs	☉
5' HEIGHT	7'	36.5"	R☒☒258F-84MD	9 / 10†	68 lbs	☉
	8'	45"	R☒☒258F-96MD	11 / 12†	74 lbs	☉
	10'	62.5"	R☒☒258F-120MD	16	88 lbs	☉
	12'	71"	R☒☒258F-144MD	19 / 18†	104 lbs	☉
	14'	79.75"	R☒☒258F-168D	21 / 22†	106 lbs	☉
	16'	96.5"	R☒☒258F-192D	26	126 lbs	☉

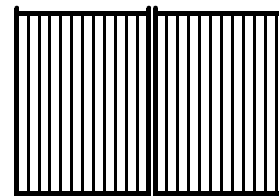

MAJESTIC™

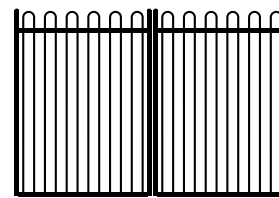

GEMINI™

☒ = GATE STYLES AVAILABLE | M = Majestic H = Gemini

☒ = COLOR OPTIONS AVAILABLE | B = Black N = Bronze

☉ = NON-STOCKED PRODUCT | For details, see Ameristar's Sales Policy in the catalog guide.

† Number of pickets per gate leaf in Gemini

Notes: Two gate leaves included for double all gates. Gate heights are nominal & gate widths are actual. For details about gate hardware included with these gates, see the Montage Gate introduction at the beginning of this section. (Hardware not included for 14' & 16' openings).

Effective: 01/01/14

MONTAGE® | 3-RAIL SINGLE SWING GATES

4" AIR GAP | STANDARD BOTTOM | GATE HARDWARE INCLUDED (excluding 7' & 8' openings)

	OPENING	LEAF WIDTH	ITEM NUMBER	PICKET QTY	WEIGHT	STOCKING
3' HEIGHT	3.5'	36.5"	W☒⊗334-42M*	7	21 lbs	☉
	4'	45"	W☒⊗334-48M	9	24 lbs	☉
	5'	62.5"	W☒⊗334-60M*	13	31 lbs	☉
	6'	71"	W☒⊗334-72M	15	34 lbs	☉
	7'	79.75"	W☒⊗334-84	17†	36 lbs	☉
	8'	96.5"	W☒⊗334-96	21	42 lbs	☉
3.5' HEIGHT	3.5'	36.5"	W☒⊗340-42M*	7	23 lbs	☉
	4'	45"	W☒⊗340-48M	9	27 lbs	☉
	5'	62.5"	W☒⊗340-60M*	13	34 lbs	☉
	6'	71"	W☒⊗340-72M	15	38 lbs	☉
	7'	79.75"	W☒⊗340-84	17†	39 lbs	☉
	8'	96.5"	W☒⊗340-96	21	47 lbs	☉
4' HEIGHT	3.5'	36.5"	W☒⊗346-42M*	7	28 lbs	<u>MB</u>
	4'	45"	W☒⊗346-48M	9	30 lbs	<u>CB MB GB</u>
	5'	62.5"	W☒⊗346-60M*	13	38 lbs	<u>CB MB GB</u>
	6'	71"	W☒⊗346-72M	15	42 lbs	<u>CB MB</u>
	7'	79.75"	W☒⊗346-84	17†	44 lbs	☉
	8'	96.5"	W☒⊗346-96	21	52 lbs	☉
5' HEIGHT	3.5'	36.5"	W☒⊗358-42M*	7	32 lbs	☉
	4'	45"	W☒⊗358-48M	9	35 lbs	<u>CB MB GB</u>
	5'	62.5"	W☒⊗358-60M*	13	44 lbs	<u>CB MB GB</u>
	6'	71"	W☒⊗358-72M	15	49 lbs	<u>CB</u>
	7'	79.75"	W☒⊗358-84	17†	51 lbs	☉
	8'	96.5"	W☒⊗358-96	21	61 lbs	☉
6' HEIGHT	3.5'	36.5"	W☒⊗370-42M*	7	37 lbs	☉
	4'	45"	W☒⊗370-48M	9	40 lbs	<u>CB MB GB</u>
	5'	62.5"	W☒⊗370-60M*	13	50 lbs	<u>CB MB</u>
	6'	71"	W☒⊗370-72M	15	56 lbs	<u>CB MB</u>
	7'	79.75"	W☒⊗370-84	17†	59 lbs	☉
	8'	96.5"	W☒⊗370-96	21	70 lbs	☉

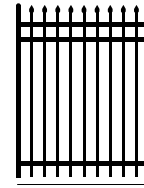

CLASSIC™

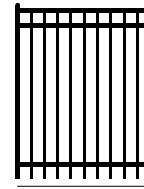

MAJESTIC™

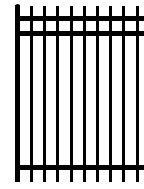

GENESIS™

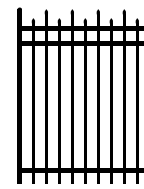

WARRIOR™

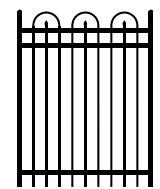

CRESCENT™

☒ = FENCE STYLES AVAILABLE | C = Classic M = Majestic G = Genesis W = Warrior L = Crescent*

⊗ = COLOR OPTIONS AVAILABLE | B = Black N = Bronze

☉ = NON-STOCKED PRODUCT | For details, see Ameristar's Sales Policy in the catalog guide.

*Not available in Crescent for 3.5' or 5' gate openings | † 18 pickets per gate leaf in Crescent

Notes: Gate heights are nominal & gate widths are actual. For details about gate hardware included with these gates, see the Montage Gate introduction at the beginning of this section. (Hardware not included for 7' & 8' openings).

Effective: 01/01/14

MONTAGE® | 3-RAIL DOUBLE SWING GATES

4" AIR GAP | STANDARD BOTTOM | GATE HARDWARE INCLUDED (excluding 14' & 16' openings)

	OPENING	LEAF WIDTH	ITEM NUMBER	PICKET QTY	WEIGHT	STOCKING
3' HEIGHT	7'	36.5"	Wⓧⓐ334-84MD*	7	44 lbs	⊙
	8'	45"	Wⓧⓐ334-96MD	9	50 lbs	⊙
	10'	62.5"	Wⓧⓐ334-120MD*	13	64 lbs	⊙
	12'	71"	Wⓧⓐ334-144MD	15	70 lbs	⊙
	14'	79.75"	Wⓧⓐ334-168D	17†	72 lbs	⊙
	16'	96.5"	Wⓧⓐ334-192D	21	84 lbs	⊙
3.5' HEIGHT	7'	36.5"	Wⓧⓐ340-84MD*	7	48 lbs	⊙
	8'	45"	Wⓧⓐ340-96MD	9	56 lbs	⊙
	10'	62.5"	Wⓧⓐ340-120MD*	13	66 lbs	⊙
	12'	71"	Wⓧⓐ340-144MD	15	78 lbs	⊙
	14'	79.75"	Wⓧⓐ340-168D	17†	80 lbs	⊙
	16'	96.5"	Wⓧⓐ340-192D	21	94 lbs	⊙
4' HEIGHT	7'	36.5"	Wⓧⓐ346-84MD*	7	56 lbs	MB
	8'	45"	Wⓧⓐ346-96MD	9	62 lbs	CB MB GB
	10'	62.5"	Wⓧⓐ346-120MD*	13	70 lbs	CB MB GB
	12'	71"	Wⓧⓐ346-144MD	15	86 lbs	CB MB
	14'	79.75"	Wⓧⓐ346-168D	17†	88 lbs	⊙
	16'	96.5"	Wⓧⓐ346-192D	21	104 lbs	⊙
5' HEIGHT	7'	36.5"	Wⓧⓐ358-84MD*	7	66 lbs	⊙
	8'	45"	Wⓧⓐ358-96MD	9	72 lbs	CB MB GB
	10'	62.5"	Wⓧⓐ358-120MD*	13	82 lbs	CB MB GB
	12'	71"	Wⓧⓐ358-144MD	15	100 lbs	CB
	14'	79.75"	Wⓧⓐ358-168D	17†	102 lbs	⊙
	16'	96.5"	Wⓧⓐ358-192D	21	122 lbs	⊙
6' HEIGHT	7'	36.5"	Wⓧⓐ370-84MD*	7	76 lbs	⊙
	8'	45"	Wⓧⓐ370-96MD	9	82 lbs	CB MB GB
	10'	62.5"	Wⓧⓐ370-120MD*	13	94 lbs	CB MB
	12'	71"	Wⓧⓐ370-144MD	15	114 lbs	CB MB
	14'	79.75"	Wⓧⓐ370-168D	17†	118 lbs	⊙
	16'	96.5"	Wⓧⓐ370-192D	21	140 lbs	⊙

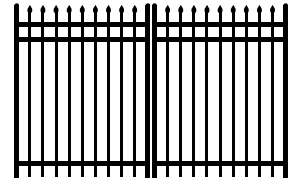

CLASSIC™

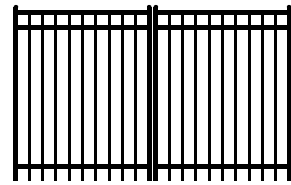

MAJESTIC™

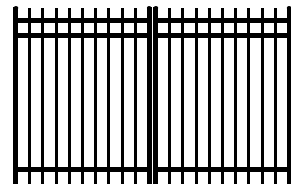

GENESIS™

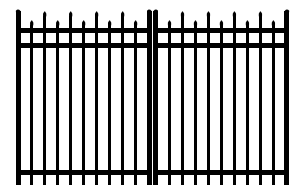

WARRIOR™

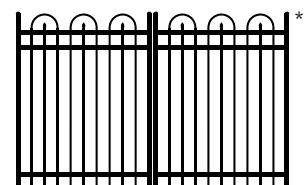

CRESCENT™

ⓧ = FENCE STYLES AVAILABLE | **C** = Classic **M** = Majestic **G** = Genesis **W** = Warrior **L** = Crescent*

ⓐ = COLOR OPTIONS AVAILABLE | **B** = Black **N** = Bronze

⊙ = NON-STOCKED PRODUCT | For details, see Ameristar's Sales Policy in the catalog guide.

*Not available in Crescent for 7' or 10' gate openings | † 18 pickets per gate leaf in Crescent

Notes: Two gate leaves included for double all gates. Gate heights are nominal & gate widths are actual. For details about gate hardware included with these gates, see the Montage Gate introduction at the beginning of this section. (Hardware not included for 14' & 16' openings).

Effective: 01/01/14

MONTAGE® | 3-RAIL SINGLE SWING GATES

3" AIR GAP | STANDARD BOTTOM | GATE HARDWARE INCLUDED (excluding 7' & 8' openings)

	OPENING	LEAF WIDTH	ITEM NUMBER	PICKET QTY	WEIGHT	STOCKING
3' HEIGHT	3.5'	36.5"	R☒☒334-42M	9 / 10†	23 lbs	☉
	4'	45"	R☒☒334-48M	11 / 12†	26 lbs	☉
	5'	62.5"	R☒☒334-60M	16	33 lbs	☉
	6'	71"	R☒☒334-72M	19 / 18†	38 lbs	☉
	7'	79.75"	R☒☒334-84	21 / 22†	39 lbs	☉
3.5' HEIGHT	3.5'	36.5"	R☒☒340-42M	9 / 10†	25 lbs	☉
	4'	45"	R☒☒340-48M	11 / 12†	29 lbs	☉
	5'	62.5"	R☒☒340-60M	16	36 lbs	☉
	6'	71"	R☒☒340-72M	19 / 18†	42 lbs	☉
	7'	79.75"	R☒☒340-84	21 / 22†	44 lbs	☉
4' HEIGHT	3.5'	36.5"	R☒☒346-42M	9 / 10†	30 lbs	☉
	4'	45"	R☒☒346-48M	11 / 12†	33 lbs	CB MB
	5'	62.5"	R☒☒346-60M	16	39 lbs	☉
	6'	71"	R☒☒346-72M	19 / 18†	47 lbs	☉
	7'	79.75"	R☒☒346-84	21 / 22†	49 lbs	☉
5' HEIGHT	3.5'	36.5"	R☒☒358-42M	9 / 10†	35 lbs	☉
	4'	45"	R☒☒358-48M	11 / 12†	39 lbs	☉
	5'	62.5"	R☒☒358-60M	16	46 lbs	☉
	6'	71"	R☒☒358-72M	19 / 18†	55 lbs	☉
	7'	79.75"	R☒☒358-84	21 / 22†	58 lbs	☉
6' HEIGHT	3.5'	36.5"	R☒☒370-42M	9 / 10†	40 lbs	☉
	4'	45"	R☒☒370-48M	11 / 12†	45 lbs	☉
	5'	62.5"	R☒☒370-60M	16	53 lbs	☉
	6'	71"	R☒☒370-72M	19 / 18†	63 lbs	☉
	7'	79.75"	R☒☒370-84	21 / 22†	67 lbs	☉
	8'	96.5"	R☒☒370-96	26	79 lbs	☉

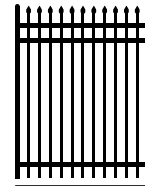

CLASSIC™

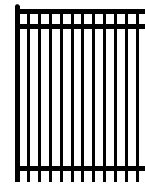

MAJESTIC™

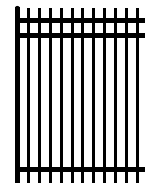

GENESIS™

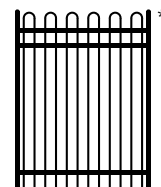

GEMINI™

☒ = FENCE STYLES AVAILABLE | **C** = Classic **M** = Majestic **G** = Genesis **H** = Gemini

☒ = COLOR OPTIONS AVAILABLE | **B** = Black **N** = Bronze

☉ = NON-STOCKED PRODUCT | For details, see Ameristar's Sales Policy in the catalog guide.

† Number of pickets per gate leaf in Gemini

Notes: Gate heights are nominal & gate widths are actual. For details about gate hardware included with these gates, see the Montage Gate introduction at the beginning of this section. (Hardware not included for 7' & 8' openings).

Effective: 01/01/14

MONTAGE® | 3-RAIL DOUBLE SWING GATES

3" AIR GAP | STANDARD BOTTOM | GATE HARDWARE INCLUDED (excluding 14' & 16' openings)

	OPENING	LEAF WIDTH	ITEM NUMBER	PICKET QTY	WEIGHT	STOCKING
3' HEIGHT	7'	36.5"	R☒ⓧ334-84MD	9 / 10†	48 lbs	⊖
	8'	45"	R☒ⓧ334-96MD	11 / 12†	54 lbs	⊖
	10'	62.5"	R☒ⓧ334-120MD	16	68 lbs	⊖
	12'	71"	R☒ⓧ334-144MD	19 / 18†	78 lbs	⊖
	14'	79.75"	R☒ⓧ334-168D	21 / 22†	80 lbs	⊖
	16'	96.5"	R☒ⓧ334-192D	26	92 lbs	⊖
3.5' HEIGHT	7'	36.5"	R☒ⓧ340-84MD	9 / 10†	52 lbs	⊖
	8'	45"	R☒ⓧ340-96MD	11 / 12†	60 lbs	⊖
	10'	62.5"	R☒ⓧ340-120MD	16	74 lbs	⊖
	12'	71"	R☒ⓧ340-144MD	19 / 18†	86 lbs	⊖
	14'	79.75"	R☒ⓧ340-168D	21 / 22†	88 lbs	⊖
	16'	96.5"	R☒ⓧ340-192D	26	102 lbs	⊖
4' HEIGHT	7'	36.5"	R☒ⓧ346-84MD	9 / 10†	62 lbs	⊖
	8'	45"	R☒ⓧ346-96MD	11 / 12†	68 lbs	CB MB
	10'	62.5"	R☒ⓧ346-120MD	16	80 lbs	⊖
	12'	71"	R☒ⓧ346-144MD	19 / 18†	96 lbs	⊖
	14'	79.75"	R☒ⓧ346-168D	21 / 22†	98 lbs	⊖
	16'	96.5"	R☒ⓧ346-192D	26	116 lbs	⊖
5' HEIGHT	7'	36.5"	R☒ⓧ358-84MD	9 / 10†	72 lbs	⊖
	8'	45"	R☒ⓧ358-96MD	11 / 12†	80 lbs	⊖
	10'	62.5"	R☒ⓧ358-120MD	16	94 lbs	⊖
	12'	71"	R☒ⓧ358-144MD	19 / 18†	112 lbs	⊖
	14'	79.75"	R☒ⓧ358-168D	21 / 22†	116 lbs	⊖
	16'	96.5"	R☒ⓧ358-192D	26	138 lbs	⊖
6' HEIGHT	7'	36.5"	R☒ⓧ370-84MD	9 / 10†	82 lbs	⊖
	8'	45"	R☒ⓧ370-96MD	11 / 12†	92 lbs	⊖
	10'	62.5"	R☒ⓧ370-120MD	16	108 lbs	⊖
	12'	71"	R☒ⓧ370-144MD	19 / 18†	130 lbs	⊖
	14'	79.75"	R☒ⓧ370-168D	21 / 22†	134 lbs	⊖
	16'	96.5"	R☒ⓧ370-192D	26	158 lbs	⊖

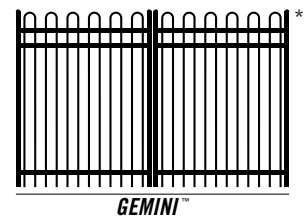
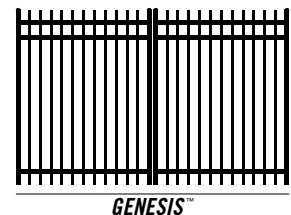
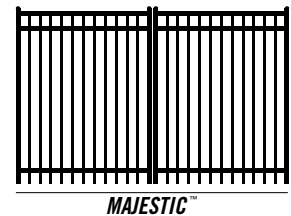
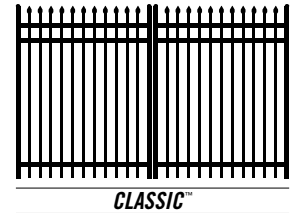

☒ = FENCE STYLES AVAILABLE | C = Classic M = Majestic G = Genesis H = Gemini

ⓧ = COLOR OPTIONS AVAILABLE | B = Black N = Bronze

⊖ = NON-STOCKED PRODUCT | For details, see Ameristar's Sales Policy in the catalog guide.

† Number of pickets per gate leaf in Gemini

Notes: Two gate leaves included for double all gates. Gate heights are nominal & gate widths are actual. For details about gate hardware included with these gates, see the Montage Gate introduction at the beginning of this section. (Hardware not included for 14' & 16' openings).

Effective: 01/01/14

MONTAGE® | 3-RAIL SINGLE SWING GATES

4" AIR GAP | FLUSH BOTTOM | GATE HARDWARE INCLUDED (excluding 7' & 8' openings)

	OPENING	LEAF WIDTH	ITEM NUMBER	PICKET QTY	WEIGHT	STOCKING
3' HEIGHT	3.5'	36.5"	W☒Ⓞ334F-42M*	7	22 lbs	☉
	4'	45"	W☒Ⓞ334F-48M	9	24 lbs	☉
	5'	62.5"	W☒Ⓞ334F-60M*	13	31 lbs	☉
	6'	71"	W☒Ⓞ334F-72M	15	34 lbs	☉
	7'	79.75"	W☒Ⓞ334F-84	17†	36 lbs	☉
	8'	96.5"	W☒Ⓞ334F-96	21	42 lbs	☉
3.5' HEIGHT	3.5'	36.5"	W☒Ⓞ340F-42M*	7	24 lbs	☉
	4'	45"	W☒Ⓞ340F-48M	9	27 lbs	☉
	5'	62.5"	W☒Ⓞ340F-60M*	13	34 lbs	☉
	6'	71"	W☒Ⓞ340F-72M	15	38 lbs	☉
	7'	79.75"	W☒Ⓞ340F-84	17†	39 lbs	☉
	8'	96.5"	W☒Ⓞ340F-96	21	47 lbs	☉
4' HEIGHT	3.5'	36.5"	W☒Ⓞ346F-42M*	7	27 lbs	☉
	4'	45"	W☒Ⓞ346F-48M	9	30 lbs	MB
	5'	62.5"	W☒Ⓞ346F-60M*	13	38 lbs	☉
	6'	71"	W☒Ⓞ346F-72M	15	42 lbs	☉
	7'	79.75"	W☒Ⓞ346F-84	17†	44 lbs	☉
	8'	96.5"	W☒Ⓞ346F-96	21	52 lbs	☉
4.5' HEIGHT	3.5' POOL	36.5"	WMⓄ354F-42P*	7	31 lbs	☉
	4' POOL	45"	WMⓄ354F-48P	9	34 lbs	☉
	5' POOL	62.5"	WMⓄ354F-60P*	13	42 lbs	☉
	6' POOL	71"	WMⓄ354F-72P	15	47 lbs	☉
	7' POOL	79.75"	WMⓄ354F-84	17	48 lbs	☉
	8' POOL	96.5"	WMⓄ354F-96	21	57 lbs	☉

5' & 6' HEIGHTS CONTINUED ON NEXT PAGE

☒ = FENCE STYLES AVAILABLE | C = Classic M = Majestic G = Genesis W = Warrior L = Crescent*

Ⓞ = COLOR OPTIONS AVAILABLE | B = Black N = Bronze

☉ = NON-STOCKED PRODUCT | For details, see Ameristar's Sales Policy in the catalog guide.

*Not available in Crescent for 3.5' or 5' gate openings | †18 pickets per gate leaf in Crescent
 Pool gates only available in Majestic

Notes: Gate heights are nominal & gate widths are actual. For details about gate hardware included with these gates, see the Montage Gate introduction at the beginning of this section. (Hardware not included for 7' & 8' openings).

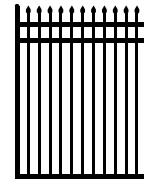

CLASSIC™

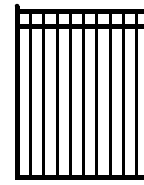

MAJESTIC™

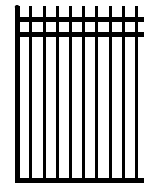

GENESIS™

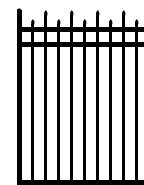

WARRIOR™

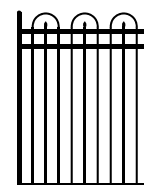

CRESCENT™

MONTAGE® | 3-RAIL SINGLE SWING GATES

4" AIR GAP | FLUSH BOTTOM | GATE HARDWARE INCLUDED (excluding 7' & 8' openings)

	OPENING	LEAF WIDTH	ITEM NUMBER	PICKET QTY	WEIGHT	STOCKING
5' HEIGHT	3.5'	36.5"	W☒Ⓞ358F-42M*	7	32 lbs	☉
	4'	45"	W☒Ⓞ358F-48M	9	35 lbs	CB MB
	5'	62.5"	W☒Ⓞ358F-60M*	13	44 lbs	MB
	6'	71"	W☒Ⓞ358F-72M	15	49 lbs	☉
	7'	79.75"	W☒Ⓞ358F-84	17†	51 lbs	☉
	8'	96.5"	W☒Ⓞ358F-96	21	61 lbs	☉
6' HEIGHT	3.5'	36.5"	W☒Ⓞ370F-42M*	7	37 lbs	☉
	4'	45"	W☒Ⓞ370F-48M	9	40 lbs	MB
	5'	62.5"	W☒Ⓞ370F-60M*	13	50 lbs	☉
	6'	71"	W☒Ⓞ370F-72M	15	56 lbs	☉
	7'	79.75"	W☒Ⓞ370F-84	17†	59 lbs	☉
	8'	96.5"	W☒Ⓞ370F-96	21	70 lbs	☉

☒ = FENCE STYLES AVAILABLE | **C** = Classic | **M** = Majestic | **G** = Genesis | **W** = Warrior | **L** = Crescent*

Ⓞ = COLOR OPTIONS AVAILABLE | **B** = Black | **N** = Bronze

☉ = NON-STOCKED PRODUCT | For details, see Ameristar's Sales Policy in the catalog guide.

*Not available in Crescent for 3.5' or 5' gate openings | †18 pickets per gate leaf in Crescent

Notes: Gate heights are nominal & gate widths are actual. For details about gate hardware included with these gates, see the Montage Gate introduction at the beginning of this section. (Hardware not included for 7' & 8' openings).

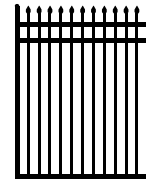

CLASSIC™

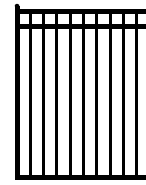

MAJESTIC™

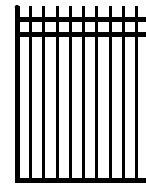

GENESIS™

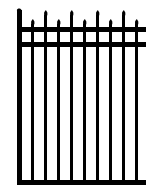

WARRIOR™

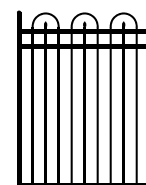

CRESCENT™

Effective: 01/01/14

MONTAGE® | 3-RAIL DOUBLE SWING GATES

4" AIR GAP | FLUSH BOTTOM | GATE HARDWARE INCLUDED (excluding 14' & 16' openings)

	OPENING	LEAF WIDTH	ITEM NUMBER	PICKET QTY	WEIGHT	STOCKING
3' HEIGHT	7'	36.5"	W☒☉334F-84MD*	7	44 lbs	☉
	8'	45"	W☒☉334F-96MD	9	50 lbs	☉
	10'	62.5"	W☒☉334F-120MD*	13	64 lbs	☉
	12'	71"	W☒☉334F-144MD	15	70 lbs	☉
	14'	79.75"	W☒☉334F-168D	17†	72 lbs	☉
3.5' HEIGHT	16'	96.5"	W☒☉334F-192D	21	84 lbs	☉
	7'	36.5"	W☒☉340F-84MD*	7	48 lbs	☉
	8'	45"	W☒☉340F-96MD	9	56 lbs	☉
	10'	62.5"	W☒☉340F-120MD*	13	66 lbs	☉
	12'	71"	W☒☉340F-144MD	15	78 lbs	☉
4' HEIGHT	14'	79.75"	W☒☉340F-168D	17†	78 lbs	☉
	16'	96.5"	W☒☉340F-192D	21	94 lbs	☉
	7'	36.5"	W☒☉346F-84MD*	7	56 lbs	☉
	8'	45"	W☒☉346F-96MD	9	62 lbs	MB
	10'	62.5"	W☒☉346F-120MD*	13	70 lbs	☉
4.5' HEIGHT	12'	71"	W☒☉346F-144MD	15	86 lbs	☉
	14'	79.75"	W☒☉346F-168D	17†	88 lbs	☉
	16'	96.5"	W☒☉346F-192D	21	104 lbs	☉
	7' POOL	36.5"	WM☒☉354F-84MD*	7	62 lbs	☉
	8' POOL	45"	WM☒☉354F-96MD	9	68 lbs	☉
4.5' HEIGHT	10' POOL	62.5"	WM☒☉354F-120MD*	13	76 lbs	☉
	12' POOL	71"	WM☒☉354F-144MD	15	94 lbs	☉
	14' POOL	79.75"	WM☒☉354F-168D	17†	96 lbs	☉
	16' POOL	96.5"	WM☒☉354F-192D	21	114 lbs	☉

5' & 6' HEIGHTS CONTINUED ON NEXT PAGE

☒ = FENCE STYLES AVAILABLE | C = Classic M = Majestic G = Genesis W = Warrior L = Crescent*

☉ = COLOR OPTIONS AVAILABLE | B = Black N = Bronze

☉ = NON-STOCKED PRODUCT | For details, see Ameristar's Sales Policy in the catalog guide.

*Not available in Crescent for 7' or 10' gate openings | † 18 pickets per gate leaf in Crescent
 Pool gates only available in Majestic

Notes: Two gate leaves included for double all gates. Gate heights are nominal & gate widths are actual. For details about gate hardware included with these gates, see the Montage Gate introduction at the beginning of this section. (Hardware not included for 14' & 16' openings).

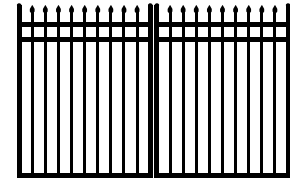

CLASSIC™

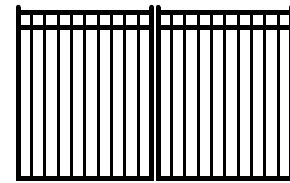

MAJESTIC™

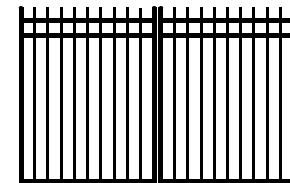

GENESIS™

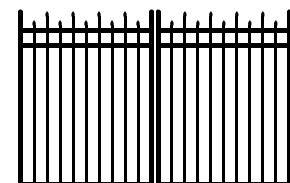

WARRIOR™

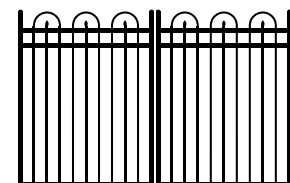

CRESCENT™

Effective: 01/01/14

MONTAGE® | 3-RAIL DOUBLE SWING GATES

4" AIR GAP | FLUSH BOTTOM | GATE HARDWARE INCLUDED (excluding 14' & 16' openings)

	OPENING	LEAF WIDTH	ITEM NUMBER	PICKET QTY	WEIGHT	STOCKING
5' HEIGHT	7'	36.5"	W☒Ⓞ358F-84MD*	7	66 lbs	☉
	8'	45"	W☒Ⓞ358F-96MD	9	72 lbs	CB MB
	10'	62.5"	W☒Ⓞ358F-120MD*	13	82 lbs	MB
	12'	71"	W☒Ⓞ358F-144MD	15	100 lbs	☉
	14'	79.75"	W☒Ⓞ358F-168D	17†	102 lbs	☉
	16'	96.5"	W☒Ⓞ358F-192D	21	122 lbs	☉
6' HEIGHT	7'	36.5"	W☒Ⓞ370F-84MD*	7	76 lbs	☉
	8'	45"	W☒Ⓞ370F-96MD	9	82 lbs	MB
	10'	62.5"	W☒Ⓞ370F-120MD*	13	94 lbs	☉
	12'	71"	W☒Ⓞ370F-144MD	15	114 lbs	☉
	14'	79.75"	W☒Ⓞ370F-168D	17†	118 lbs	☉
	16'	96.5"	W☒Ⓞ370F-192D	21	140 lbs	☉

☒ = FENCE STYLES AVAILABLE | **C** = Classic **M** = Majestic **G** = Genesis **W** = Warrior **L** = Crescent*

Ⓞ = COLOR OPTIONS AVAILABLE | **B** = Black **N** = Bronze

☉ = NON-STOCKED PRODUCT | For details, see Ameristar's Sales Policy in the catalog guide.

*Not available in Crescent for 7' or 10' gate openings | †18 pickets per gate leaf in Crescent

Notes: Two gate leaves included for double all gates. Gate heights are nominal & gate widths are actual. For details about gate hardware included with these gates, see the Montage Gate introduction at the beginning of this section. (Hardware not included for 14' & 16' openings).

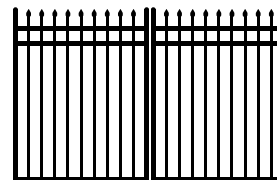

CLASSIC™

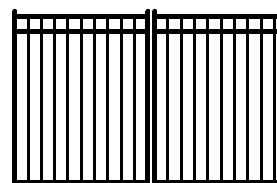

MAJESTIC™

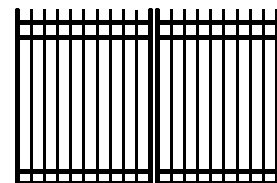

GENESIS™

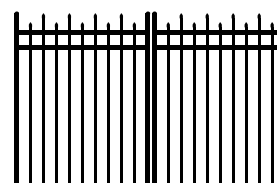

WARRIOR™

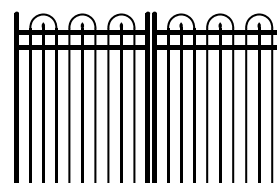

CRESCENT™

Effective: 01/01/14

MONTAGE® | 3-RAIL SINGLE SWING GATES

3" AIR GAP | FLUSH BOTTOM | GATE HARDWARE INCLUDED (excluding 7' & 8' openings)

	OPENING	LEAF WIDTH	ITEM NUMBER	PICKET QTY	WEIGHT	STOCKING
3' HEIGHT	3.5'	36.5"	R☒Ⓞ334F-42M	9 / 10†	23 lbs	☉
	4'	45"	R☒Ⓞ334F-48M	11 / 12†	26 lbs	☉
	5'	62.5"	R☒Ⓞ334F-60M	16	33 lbs	☉
	6'	71"	R☒Ⓞ334F-72M	19 / 18†	38 lbs	☉
	7'	79.75"	R☒Ⓞ334F-84	21 / 22†	39 lbs	☉
3.5' HEIGHT	3.5'	36.5"	R☒Ⓞ340F-42M	9 / 10†	25 lbs	☉
	4'	45"	R☒Ⓞ340F-48M	11 / 12†	29 lbs	☉
	5'	62.5"	R☒Ⓞ340F-60M	16	36 lbs	☉
	6'	71"	R☒Ⓞ340F-72M	19 / 18†	42 lbs	☉
	7'	79.75"	R☒Ⓞ340F-84	21 / 22†	44 lbs	☉
4' HEIGHT	3.5'	36.5"	R☒Ⓞ346F-42M	9 / 10†	30 lbs	☉
	4'	45"	R☒Ⓞ346F-48M	11 / 12†	33 lbs	☉
	5'	62.5"	R☒Ⓞ346F-60M	16	39 lbs	☉
	6'	71"	R☒Ⓞ346F-72M	19 / 18†	47 lbs	☉
	7'	79.75"	R☒Ⓞ346F-84	21 / 22†	49 lbs	☉
4.5' HEIGHT	3.5' POOL	36.5"	RM☒Ⓞ354F-42P	9 / 10†	34 lbs	☉
	4' POOL	45"	RM☒Ⓞ354F-48P	11 / 12†	37 lbs	☉
	5' POOL	62.5"	RM☒Ⓞ354F-60P	16	44 lbs	☉
	6' POOL	71"	RM☒Ⓞ354F-72P	19 / 18†	54 lbs	☉
	7' POOL	79.75"	RM☒Ⓞ354F-84	21 / 22†	54 lbs	☉
	8' POOL	96.5"	RM☒Ⓞ354F-96	26	64 lbs	☉

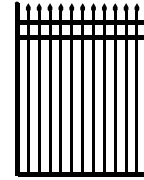

CLASSIC™

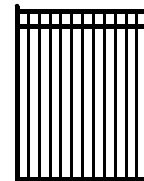

MAJESTIC™

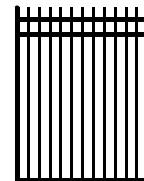

GENESIS™

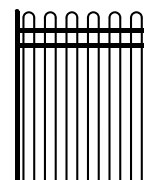

GEMINI™

5' & 6' HEIGHTS CONTINUED ON NEXT PAGE

☒ = FENCE STYLES AVAILABLE | C = Classic M = Majestic G = Genesis H = Gemini

Ⓞ = COLOR OPTIONS AVAILABLE | B = Black N = Bronze

☉ = NON-STOCKED PRODUCT | For details, see Ameristar's Sales Policy in the catalog guide.

Pool gates only available in Majestic | † Number of pickets per gate leaf in Gemini

Notes: Gate heights are nominal & gate widths are actual. For details about gate hardware included with these gates, see the Montage Gate introduction at the beginning of this section. (Hardware not included for 7' & 8' openings).

Effective: 01/01/14

MONTAGE® | 3-RAIL SINGLE SWING GATES

3" AIR GAP | FLUSH BOTTOM | GATE HARDWARE INCLUDED (excluding 7' & 8' openings)

	OPENING	LEAF WIDTH	ITEM NUMBER	PICKET QTY	WEIGHT	STOCKING
5' HEIGHT	3.5'	36.5"	R☒ⓧ358F-42M	9 / 10†	35 lbs	☉
	4'	45"	R☒ⓧ358F-48M	11 / 12†	39 lbs	☉
	5'	62.5"	R☒ⓧ358F-60M	16	46 lbs	☉
	6'	71"	R☒ⓧ358F-72M	19 / 18†	55 lbs	☉
	7'	79.75"	R☒ⓧ358F-84	21 / 22†	58 lbs	☉
6' HEIGHT	8'	96.5"	R☒ⓧ358F-96	26	69 lbs	☉
	3.5'	36.5"	R☒ⓧ370F-42M	9 / 10†	40 lbs	☉
	4'	45"	R☒ⓧ370F-48M	11 / 12†	45 lbs	☉
	5'	62.5"	R☒ⓧ370F-60M	16	53 lbs	☉
	6'	71"	R☒ⓧ370F-72M	19 / 18†	63 lbs	☉
	7'	79.75"	R☒ⓧ370F-84	21 / 22†	67 lbs	☉
	8'	96.5"	R☒ⓧ370F-96	26	79 lbs	☉

☒ = FENCE STYLES AVAILABLE | C = Classic | M = Majestic | G = Genesis | H = Gemini

ⓧ = COLOR OPTIONS AVAILABLE | B = Black | N = Bronze

☉ = NON-STOCKED PRODUCT | For details, see Ameristar's Sales Policy in the catalog guide.

† Number of pickets per gate leaf in Gemini

Notes: Gate heights are nominal & gate widths are actual. For details about gate hardware included with these gates, see the Montage Gate introduction at the beginning of this section. (Hardware not included for 7' & 8' openings).

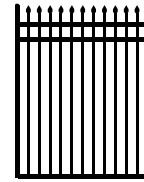

CLASSIC™

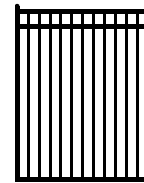

MAJESTIC™

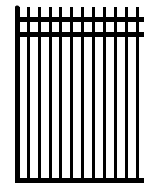

GENESIS™

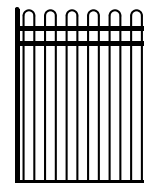

GEMINI™

Effective: 01/01/14

MONTAGE® | 3-RAIL DOUBLE SWING GATES

3" AIR GAP | FLUSH BOTTOM | GATE HARDWARE INCLUDED (excluding 14' & 16' openings)

	OPENING	LEAF WIDTH	ITEM NUMBER	PICKET QTY	WEIGHT	STOCKING
3' HEIGHT	7'	36.5"	R☒Ⓞ334F-84MD	9 / 10†	48 lbs	☉
	8'	45"	R☒Ⓞ334F-96MD	11 / 12†	54 lbs	☉
	10'	62.5"	R☒Ⓞ334F-120MD	16	68 lbs	☉
	12'	71"	R☒Ⓞ334F-144MD	19 / 18†	78 lbs	☉
	14'	79.75"	R☒Ⓞ334F-168D	21 / 22†	80 lbs	☉
	16'	96.5"	R☒Ⓞ334F-192D	26	92 lbs	☉
3.5' HEIGHT	7'	36.5"	R☒Ⓞ340F-84MD	9 / 10†	52 lbs	☉
	8'	45"	R☒Ⓞ340F-96MD	11 / 12†	60 lbs	☉
	10'	62.5"	R☒Ⓞ340F-120MD	16	74 lbs	☉
	12'	71"	R☒Ⓞ340F-144MD	19 / 18†	86 lbs	☉
	14'	79.75"	R☒Ⓞ340F-168D	21 / 22†	88 lbs	☉
	16'	96.5"	R☒Ⓞ340F-192D	26	102 lbs	☉
4' HEIGHT	7'	36.5"	R☒Ⓞ346F-84MD	9 / 10†	62 lbs	☉
	8'	45"	R☒Ⓞ346F-96MD	11 / 12†	68 lbs	☉
	10'	62.5"	R☒Ⓞ346F-120MD	16	80 lbs	☉
	12'	71"	R☒Ⓞ346F-144MD	19 / 18†	96 lbs	☉
	14'	79.75"	R☒Ⓞ346F-168D	21 / 22†	98 lbs	☉
	16'	96.5"	R☒Ⓞ346F-192D	26	116 lbs	☉
4.5' HEIGHT	7' POOL	36.5"	RMⓄ354F-84MD	9 / 10†	68 lbs	☉
	8' POOL	45"	RMⓄ354F-96MD	11 / 12†	74 lbs	☉
	10' POOL	62.5"	RMⓄ354F-120MD	16	88 lbs	☉
	12' POOL	71"	RMⓄ354F-144MD	19 / 18†	108 lbs	☉
	14' POOL	79.75"	RMⓄ354F-168D	21 / 22†	110 lbs	☉
	16' POOL	96.5"	RMⓄ354F-192D	26	128 lbs	☉

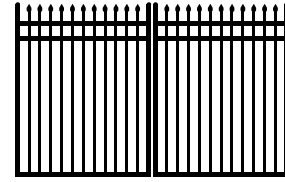

CLASSIC™

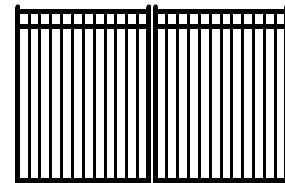

MAJESTIC™

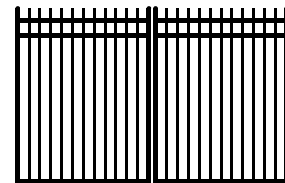

GENESIS™

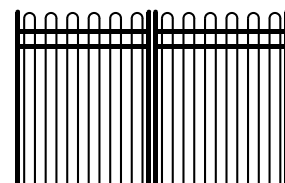

GEMINI™*

5' & 6' HEIGHTS CONTINUED ON NEXT PAGE

☒ = FENCE STYLES AVAILABLE | C = Classic M = Majestic G = Genesis H = Gemini

Ⓞ = COLOR OPTIONS AVAILABLE | B = Black N = Bronze

☉ = NON-STOCKED PRODUCT | For details, see Ameristar's Sales Policy in the catalog guide.

Pool gates only available in Majestic | † Number of pickets per gate leaf in Gemini

Notes: Two gate leaves included for double all gates. Gate heights are nominal & gate widths are actual. For details about gate hardware included with these gates, see the Montage Gate introduction at the beginning of this section. (Hardware not included for 14' & 16' openings).

Effective: 01/01/14

MONTAGE® | 3-RAIL DOUBLE SWING GATES

3" AIR GAP | FLUSH BOTTOM | GATE HARDWARE INCLUDED (excluding 14' & 16' openings)

	OPENING	LEAF WIDTH	ITEM NUMBER	PICKET QTY	WEIGHT	STOCKING
5' HEIGHT	7'	36.5"	R☒⊗358F-84MD	9 / 10†	72lbs	☉
	8'	45"	R☒⊗358F-96MD	11 / 12†	80 lbs	☉
	10'	62.5"	R☒⊗358F-120MD	16	94 lbs	☉
	12'	71"	R☒⊗358F-144MD	19 / 18†	112 lbs	☉
	14'	79.75"	R☒⊗358F-168D	21 / 22†	116 lbs	☉
6' HEIGHT	16'	96.5"	R☒⊗358F-192D	26	138 lbs	☉
	7'	36.5"	R☒⊗370F-84MD	9 / 10†	82 lbs	☉
	8'	45"	R☒⊗370F-96MD	11 / 12†	92 lbs	☉
	10'	62.5"	R☒⊗370F-120MD	16	108 lbs	☉
	12'	71"	R☒⊗370F-144MD	19 / 18†	130 lbs	☉
	14'	79.75"	R☒⊗370F-168D	21 / 22†	134 lbs	☉
	16'	96.5"	R☒⊗370F-192D	26	158 lbs	☉

☒ = FENCE STYLES AVAILABLE | C = Classic M = Majestic G = Genesis W = Warrior H = Gemini

⊗ = COLOR OPTIONS AVAILABLE | B = Black N = Bronze

☉ = NON-STOCKED PRODUCT | For details, see Ameristar's Sales Policy in the catalog guide.

† Number of pickets per gate leaf in Gemini

Notes: Two gate leaves included for double all gates. Gate heights are nominal & gate widths are actual. For details about gate hardware included with these gates, see the Montage Gate introduction at the beginning of this section. (Hardware not included for 14' & 16' openings).

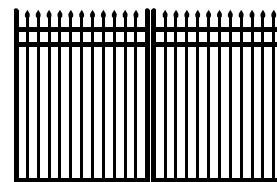

CLASSIC™

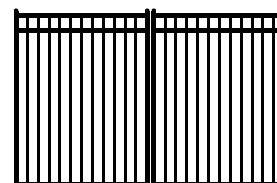

MAJESTIC™

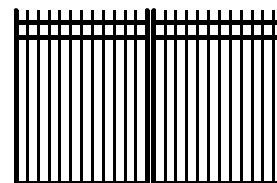

GENESIS™

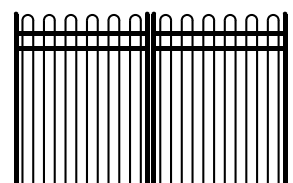

GEMINI™*

Effective: 01/01/14



Effective: 01/01/14

MONTAGE® | SINGLE SWING ARCHED GATE SPECIFICATIONS

1.25"sq x 16ga GATE ENDS | .9375"w x 1.25"h x 14ga RAILS | .590"sq x 18ga PICKETS

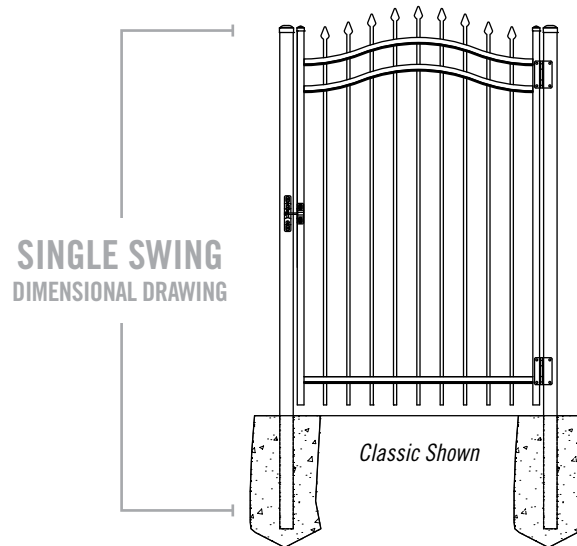

SINGLE SWING
ARCHED
HARDWARE KITS &
POST INTERSPACES

OPENING	LEAF WIDTH*	D&D GATE HARDWARE KIT			D&D POOL GATE HARDWARE KIT		
		HC	LC	P _s	HC	LC	P _s
3.5'	36.5"	1.125"	.75"	38.375"	1.125"	.75"	38.375"
4'	45"	1.125"	.75"	46.875"	1.125"	.75"	46.875"
5'	62.5"	1.125"	.75"	64.375"	1.125"	.75"	64.375"
6'	71"	1.125"	.75"	72.875"	1.125"	.75"	72.875"

W = width* | HC = hinge clearance | LC = latch clearance | P_s = gate post spacing**
* From outside to outside | ** From inside to inside

DSKM gate hardware included / see section for specific details
DSKP gate hardware (pool gates) included / see section for specific details

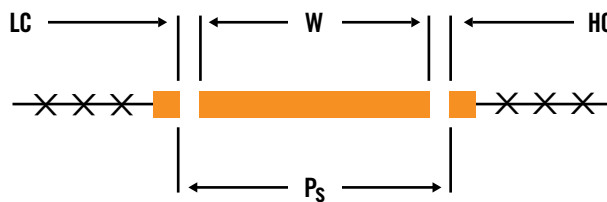

Effective: 01/01/14

MONTAGE® | 2-RAIL SINGLE ARCHED SWING GATES

4" AIR GAP | STANDARD BOTTOM | GATE HARDWARE INCLUDED

	OPENING	LEAF WIDTH	ITEM NUMBER	PICKET QTY	WEIGHT	STOCKING
3' HEIGHT	3.5'	36.5"	W☒⊗234-42AM	7	20 lbs	☉
	4'	45"	W☒⊗234-48AM	9	24 lbs	☉
	5'	62.5"	W☒⊗234-60AM	13	29 lbs	☉
	6'	71"	W☒⊗234-72AM	15	33 lbs	☉
3.5' HEIGHT	3.5'	36.5"	W☒⊗240-42AM	7	22 lbs	☉
	4'	45"	W☒⊗240-48AM	9	26 lbs	☉
	5'	62.5"	W☒⊗240-60AM	13	33 lbs	☉
	6'	71"	W☒⊗240-72AM	15	38 lbs	☉
4' HEIGHT	3.5'	36.5"	W☒⊗246-42AM	7	26 lbs	☉
	4'	45"	W☒⊗246-48AM	9	29 lbs	☉
	5'	62.5"	W☒⊗246-60AM	13	36 lbs	☉
	6'	71"	W☒⊗246-72AM	15	39 lbs	☉
5' HEIGHT	3.5'	36.5"	W☒⊗258-42AM	7	28 lbs	☉
	4'	45"	W☒⊗258-48AM	9	34 lbs	☉
	5'	62.5"	W☒⊗258-60AM	13	40 lbs	☉
	6'	71"	W☒⊗258-72AM	15	46 lbs	☉

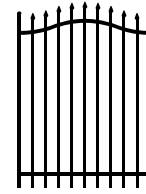

CLASSIC™

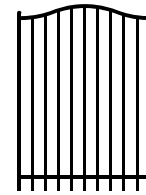

MAJESTIC™

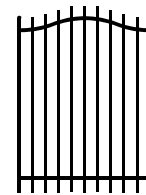

GENESIS™

☒ = FENCE STYLES AVAILABLE | C = Classic M = Majestic G = Genesis

⊗ = COLOR OPTIONS AVAILABLE | B = Black N = Bronze

☉ = NON-STOCKED PRODUCT | For details, see Ameristar's Sales Policy in the catalog guide.

Notes: Gate heights are nominal & gate widths are actual. For details about gate hardware included with these gates, see the Montage Gate introduction at the beginning of this section.

Effective: 01/01/14

MONTAGE® | 2-RAIL SINGLE ARCHED SWING GATES

4" AIR GAP | FLUSH BOTTOM | GATE HARDWARE INCLUDED

	OPENING	LEAF WIDTH	ITEM NUMBER	PICKET QTY	WEIGHT	STOCKING
3' HEIGHT	3.5'	36.5"	W☒Ⓞ234F-42AM	7	20 lbs	☉
	4'	45"	W☒Ⓞ234F-48AM	9	25 lbs	☉
	5'	62.5"	W☒Ⓞ234F-60AM	13	29 lbs	☉
	6'	71"	W☒Ⓞ234F-72AM	15	33 lbs	☉
3.5' HEIGHT	3.5'	36.5"	W☒Ⓞ240F-42AM	7	22 lbs	☉
	4'	45"	W☒Ⓞ240F-48AM	9	26 lbs	☉
	5'	62.5"	W☒Ⓞ240F-60AM	13	33 lbs	☉
	6'	71"	W☒Ⓞ240F-72AM	15	38 lbs	☉
4' HEIGHT	3.5'	36.5"	W☒Ⓞ246F-42AM	7	26 lbs	☉
	4'	45"	W☒Ⓞ246F-48AM	9	29 lbs	☉
	5'	62.5"	W☒Ⓞ246F-60AM	13	36 lbs	☉
	6'	71"	W☒Ⓞ246F-72AM	15	39 lbs	☉
4' HEIGHT	3.5' POOL	36.5"	WM☒Ⓞ246F-42AP	7	26 lbs	☉
	4' POOL	45"	WM☒Ⓞ246F-48AP	9	29 lbs	☉
	5' POOL	62.5"	WM☒Ⓞ246F-60AP	13	36 lbs	☉
	6' POOL	71"	WM☒Ⓞ246F-72AP	15	39 lbs	☉
5' HEIGHT	3.5'	36.5"	W☒Ⓞ258F-42AM	7	28 lbs	☉
	4'	45"	W☒Ⓞ258F-48AM	9	34 lbs	☉
	5'	62.5"	W☒Ⓞ258F-60AM	13	40 lbs	☉
	6'	71"	W☒Ⓞ258F-72AM	15	46lbs	☉

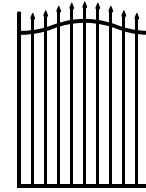

CLASSIC™

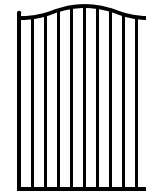

MAJESTIC™

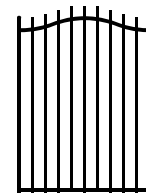

GENESIS™

☒ = FENCE STYLES AVAILABLE | C = Classic M = Majestic G = Genesis

Ⓞ = COLOR OPTIONS AVAILABLE | B = Black N = Bronze

☉ = NON-STOCKED PRODUCT | For details, see Ameristar's Sales Policy in the catalog guide.

Pool gates only available in Majestic

Notes: Gate heights are nominal & gate widths are actual. For details about gate hardware included with these gates, see the Montage Gate introduction at the beginning of this section.

Effective: 01/01/14

MONTAGE® | 3-RAIL SINGLE ARCHED SWING GATES

4" AIR GAP | STANDARD BOTTOM | GATE HARDWARE INCLUDED

	OPENING	LEAF WIDTH	ITEM NUMBER	PICKET QTY	WEIGHT	STOCKING
3' HEIGHT	3.5'	36.5"	W☒Ⓞ334-42AM	7	22 lbs	☉
	4'	45"	W☒Ⓞ334-48AM	9	26 lbs	☉
	5'	62.5"	W☒Ⓞ334-60AM	13	33 lbs	☉
	6'	71"	W☒Ⓞ334-72AM	15	37 lbs	☉
3.5' HEIGHT	3.5'	36.5"	W☒Ⓞ340-42AM	7	24 lbs	☉
	4'	45"	W☒Ⓞ340-48AM	9	29 lbs	☉
	5'	62.5"	W☒Ⓞ340-60AM	13	36 lbs	☉
	6'	71"	W☒Ⓞ340-72AM	15	41 lbs	☉
4' HEIGHT	3.5'	36.5"	W☒Ⓞ346-42AM	7	28 lbs	☉
	4'	45"	W☒Ⓞ346-48AM	9	32 lbs	☉
	5'	62.5"	W☒Ⓞ346-60AM	13	40 lbs	☉
	6'	71"	W☒Ⓞ346-72AM	15	45 lbs	☉
5' HEIGHT	3.5'	36.5"	W☒Ⓞ358-42AM	7	33 lbs	☉
	4'	45"	W☒Ⓞ358-48AM	9	37 lbs	☉
	5'	62.5"	W☒Ⓞ358-60AM	13	46 lbs	☉
	6'	71"	W☒Ⓞ358-72AM	15	52 lbs	☉
6' HEIGHT	3.5'	36.5"	W☒Ⓞ370-42AM	7	38 lbs	☉
	4'	45"	W☒Ⓞ370-48AM	9	42 lbs	☉
	5'	62.5"	W☒Ⓞ370-60AM	13	52 lbs	☉
	6'	71"	W☒Ⓞ370-72AM	15	59 lbs	☉

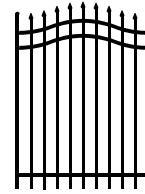

CLASSIC™

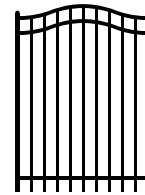

MAJESTIC™

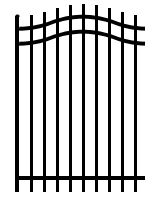

GENESIS™

☒ = FENCE STYLES AVAILABLE | C = Classic M = Majestic G = Genesis

Ⓞ = COLOR OPTIONS AVAILABLE | B = Black N = Bronze

☉ = NON-STOCKED PRODUCT | For details, see Ameristar's Sales Policy in the catalog guide.

Notes: Gate heights are nominal & gate widths are actual. For details about gate hardware included with these gates, see the Montage Gate introduction at the beginning of this section.

Effective: 01/01/14

MONTAGE® | 3-RAIL SINGLE ARCHED SWING GATES

4" AIR GAP | FLUSH BOTTOM | GATE HARDWARE INCLUDED

	OPENING	LEAF WIDTH	ITEM NUMBER	PICKET QTY	WEIGHT	STOCKING
3' HEIGHT	3.5'	36.5"	W☒Ⓞ334F-42AM	7	23 lbs	☉
	4'	45"	W☒Ⓞ334F-48AM	9	26 lbs	☉
	5'	62.5"	W☒Ⓞ334F-60AM	13	33 lbs	☉
	6'	71"	W☒Ⓞ334F-72AM	15	37 lbs	☉
3.5' HEIGHT	3.5'	36.5"	W☒Ⓞ340F-42AM	7	24 lbs	☉
	4'	45"	W☒Ⓞ340F-48AM	9	29 lbs	☉
	5'	62.5"	W☒Ⓞ340F-60AM	13	36 lbs	☉
	6'	71"	W☒Ⓞ340F-72AM	15	41 lbs	☉
4' HEIGHT	3.5'	36.5"	W☒Ⓞ346F-42AM	7	28 lbs	☉
	4'	45"	W☒Ⓞ346F-48AM	9	32 lbs	☉
	5'	62.5"	W☒Ⓞ346F-60AM	13	40 lbs	☉
	6'	71"	W☒Ⓞ346F-72AM	15	45 lbs	☉
4.5' HEIGHT	3.5' POOL	36.5"	WMⓄ354F-42AP	7	31 lbs	☉
	4' POOL	45"	WMⓄ354F-48AP	9	35 lbs	☉
	5' POOL	62.5"	WMⓄ354F-60AP	13	43 lbs	☉
	6' POOL	71"	WMⓄ354F-72AP	15	48 lbs	☉
5' HEIGHT	3.5'	36.5"	W☒Ⓞ358F-42AM	7	33 lbs	☉
	4'	45"	W☒Ⓞ358F-48AM	9	38 lbs	☉
	5'	62.5"	W☒Ⓞ358F-60AM	13	46 lbs	☉
	6'	71"	W☒Ⓞ358F-72AM	15	52 lbs	☉
6' HEIGHT	3.5'	36.5"	W☒Ⓞ370F-42AM	7	38 lbs	☉
	4'	45"	W☒Ⓞ370F-48AM	9	42 lbs	☉
	5'	62.5"	W☒Ⓞ370F-60AM	13	52 lbs	☉
	6'	71"	W☒Ⓞ370F-72AM	15	59 lbs	☉

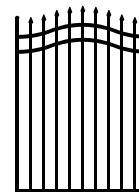

CLASSIC™

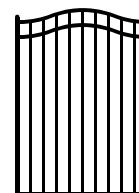

MAJESTIC™

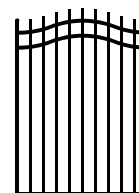

GENESIS™

☒ = FENCE STYLES AVAILABLE | C = Classic M = Majestic G = Genesis

Ⓞ = COLOR OPTIONS AVAILABLE | B = Black N = Bronze

☉ = NON-STOCKED PRODUCT | For details, see Ameristar's Sales Policy in the catalog guide.

Pool gates only available in Majestic

Notes: Gate heights are nominal & gate widths are actual. For details about gate hardware included with these gates, see the Montage Gate introduction at the beginning of this section.

Effective: 01/01/14

MONTAGE® | GATE KITS & GATE ENDS

SINGLE SWING GATE KIT

PANEL HEIGHT	GATE END LENGTH	ITEM NUMBER	WEIGHT
4'	46"	W⓪46-WG	14 lbs
5'	58"	W⓪58-WG	16 lbs
6'	70"	W⓪70-WG	18 lbs

Each single swing gate kit includes:
 (2) Gate Ends / 1.25" sq. | (2) Frame Hinges / Female / 1.25" sq.
 (2) Post Hinges / Male / 2" sq. | (1) Latch Fork / 2" | (1) Latch Collar / 1.25"

DOUBLE SWING GATE KIT

PANEL HEIGHT	GATE END LENGTH	ITEM NUMBER	WEIGHT
4'	46"	W⓪46-DD	32 lbs
5'	58"	W⓪58-DD	36 lbs
6'	70"	W⓪70-DD	40 lbs

Each double swing gate kit includes:
 (4) Gate Ends / 1.25" sq. | (6) Frame Hinges / Female / 1.25" sq. | (1) Cane Bolt / 48"
 (4) Post Hinges / Male / 2" sq. | (1) Latch Fork / 1.25" | (1) Latch Collar / 1.25"

⓪ = COLOR OPTIONS AVAILABLE | **B** = Black | **N** = Bronze

Notes: Gate kits intended for use with Majestic flush bottom panels should be purchased one foot taller than panel height. Gates fabricated by welding gate ends to panel remnants are excluded from Ameristar's welded fence warranty.

GATE ENDS

LENGTH	ITEM NUMBER	BOX QTY	WEIGHT
1.25" x 34"	H⓪234	8	2.90 lbs
1.25" x 40"	H⓪240	8	3.45 lbs
1.25" x 46"	H⓪246	8	3.83 lbs
1.25" x 48"	H⓪248	8	4.00 lbs
1.25" x 58"	H⓪258	8	4.95 lbs
1.25" x 59"	H⓪259	8	5.05 lbs
1.25" x 70"	H⓪270	8	6.00 lbs
1.25" x 71"	H⓪271	8	6.30 lbs

⓪ = COLOR OPTIONS AVAILABLE | **B** = Black | **N** = Bronze

Notes: 1.25" sq. PVC caps are included in box for each gate end

